

TARIF 2026
PVP 2025 + **7%**
En vigueur à partir du 4 mai 2026

BLUE-MASTER[®]
by *ce/esa*



OUTILS 1/4"

EMBOUS DE VISSAGE

Embout de vissage

Rose

Plus

25mm
LONGUEUR
TOTALE
(L)

PHILLIPS



€ x Embout

2 Unités

5 Unités

50 Unités

100 Unités

	L1 mm		€		€		€		€
Ph 0	25	Ph0-2	1,54	Ph0-5	1,34	Ph0-50	1,20	Ph0-100	1,14
Ph 1	25	Ph1-2	1,29	Ph1-5	0,80	Ph1-50	0,73	Ph1-100	0,67
Ph 2	25	Ph2-2	1,29	Ph2-5	0,80	Ph2-50	0,73	Ph2-100	0,67
Ph 3	25	Ph3-2	1,29	Ph3-5	0,80	Ph3-50	0,73	Ph3-100	0,67

POZIDRIV



€ x Embout

2 Unités

5 Unités

50 Unités

100 Unités

	L1 mm		€		€		€		€
Pz 0	25	Pz0-2	1,54	Pz0-5	1,34	Pz0-50	1,20	Pz0-100	1,14
Pz 1	25	Pz1-2	1,29	Pz1-5	0,80	Pz1-50	0,73	Pz1-100	0,67
Pz 2	25	Pz2-2	1,29	Pz2-5	0,80	Pz2-50	0,73	Pz2-100	0,67
Pz 3	25	Pz3-2	1,29	Pz3-5	0,80	Pz3-50	0,73	Pz3-100	0,67

PLAT



€ x Embout

2 Unités

5 Unités

50 Unités

100 Unités

	L1 mm		€		€		€		€
0,5X3,0	25	P0,5X3,0-2	1,72	P0,5X3,0-5	1,50	P0,5X3,0-50	1,36	P0,5X3,0-100	1,28
0,6X3,5	25	P0,6X3,5-2	1,72	P0,6X3,5-5	1,50	P0,6X3,5-50	1,36	P0,6X3,5-100	1,28
0,5X4,0	25	P0,5X4,0-2	1,72	P0,5X4,0-5	1,50	P0,5X4,0-50	1,36	P0,5X4,0-100	1,28
0,6X4,5	25	P0,6X4,5-2	1,72	P0,6X4,5-5	1,50	P0,6X4,5-50	1,36	P0,6X4,5-100	1,28
0,8X4,0	25	P0,8X4,0-2	1,72	P0,8X4,0-5	1,50	P0,8X4,0-50	1,36	P0,8X4,0-100	1,28
0,8X5,0	25	P0,8X5,0-2	1,72	P0,8X5,0-5	1,50	P0,8X5,0-50	1,36	P0,8X5,0-100	1,28
0,8X5,5	25	P0,8X5,5-2	1,72	P0,8X5,5-5	1,50	P0,8X5,5-50	1,36	P0,8X5,5-100	1,28
1,0X5,5	25	P1X5,5-2	1,72	P1X5,5-5	1,50	P1X5,5-50	1,36	P1X5,5-100	1,28
1,0X6,0	25	P1X6,0-2	1,72	P1X6,0-5	1,50	P1X6,0-50	1,36	P1X6,0-100	1,28
1,2X6,5	25	P1,2X6,5-2	1,72	P1,2X6,5-5	1,50	P1,2X6,5-50	1,36	P1,2X6,5-100	1,28
1,2X8,0	25	P1,2X8,0-2	1,72	P1,2X8,0-5	1,50	P1,2X8,0-50	1,36	P1,2X8,0-100	1,28

EMBOUS DE VISSAGE



25mm
LONGUEUR
TOTALE
(L)



Embouts de vissage
Rose

TORX



€ x Embout		2 Unités		5 Unités		50 Unités		100 Unités	
	L1 mm		€		€		€		€
T5	25	PT5-2	2,28	PT5-5	1,98	PT5-50	1,78	PT5-100	1,68
T6	25	PT6-2	2,28	PT6-5	1,98	PT6-50	1,78	PT6-100	1,68
T7	25	PT7-2	2,28	PT7-5	1,98	PT7-50	1,78	PT7-100	1,68
T8	25	PT8-2	2,28	PT8-5	1,98	PT8-50	1,78	PT8-100	1,68
T9	25	PT9-2	2,28	PT9-5	1,98	PT9-50	1,78	PT9-100	1,68
T10	25	PT10-2	1,87	PT10-5	1,46	PT10-50	1,31	PT10-100	1,23
T15	25	PT15-2	1,87	PT15-5	1,46	PT15-50	1,31	PT15-100	1,23
T20	25	PT20-2	1,87	PT20-5	1,46	PT20-50	1,31	PT20-100	1,23
T25	25	PT25-2	1,87	PT25-5	1,46	PT25-50	1,31	PT25-100	1,23
T27	25	PT27-2	1,87	PT27-5	1,46	PT27-50	1,31	PT27-100	1,23
T30	25	PT30-2	1,87	PT30-5	1,46	PT30-50	1,31	PT30-100	1,23
T40	25	PT40-2	1,87	PT40-5	1,46	PT40-50	1,31	PT40-100	1,23

TORX
ROND



€ x Embout		2 Unités		5 Unités		50 Unités		100 Unités	
	L1 mm		€		€		€		€
TR10	25	PTR10-2	6,07	PTR10-5	5,26	PTR10-50	4,74	PTR10-100	4,46
TR15	25	PTR15-2	6,07	PTR15-5	5,26	PTR15-50	4,74	PTR15-100	4,46
TR20	25	PTR20-2	6,07	PTR20-5	5,26	PTR20-50	4,74	PTR20-100	4,46
TR25	25	PTR25-2	6,07	PTR25-5	5,26	PTR25-50	4,74	PTR25-100	4,46
TR30	25	PTR30-2	6,07	PTR30-5	5,26	PTR30-50	4,74	PTR30-100	4,46
TR40	25	PTR40-2	6,07	PTR40-5	5,26	PTR40-50	4,74	PTR40-100	4,46

ROBERTSON



€ x Embout		2 Unités		5 Unités		50 Unités		100 Unités	
	L1 mm		€		€		€		€
N°1	25	PC1-2	2,44	PC1-5	2,13	PC1-50	1,91	PC1-100	1,81
N°2	25	PC2-2	2,44	PC2-5	2,13	PC2-50	1,91	PC2-100	1,81
N°3	25	PC3-2	2,44	PC3-5	2,13	PC3-50	1,91	PC3-100	1,81

EMBOUITS DE VISSAGE

Plus

25mm
LONGUEUR
TOTALE
(L)TORX
SÉCURITÉ

€ x Embout		2 Unités		5 Unités		50 Unités		100 Unités	
	L1 mm		€		€		€		€
TS10	25	PTS10-2	3,24	PTS10-5	2,82	PTS10-50	2,54	PTS10-100	2,40
TS15	25	PTS15-2	3,24	PTS15-5	2,82	PTS15-50	2,54	PTS15-100	2,40
TS20	25	PTS20-2	3,24	PTS20-5	2,82	PTS20-50	2,54	PTS20-100	2,40
TS25	25	PTS25-2	3,24	PTS25-5	2,82	PTS25-50	2,54	PTS25-100	2,40
TS27	25	PTS27-2	3,24	PTS27-5	2,82	PTS27-50	2,54	PTS27-100	2,40
TS30	25	PTS30-2	3,24	PTS30-5	2,82	PTS30-50	2,54	PTS30-100	2,40
TS40	25	PTS40-2	3,24	PTS40-5	2,82	PTS40-50	2,54	PTS40-100	2,40

HEXAGONAL



€ x Embout		2 Unités		5 Unités		50 Unités		100 Unités	
	L1 mm		€		€		€		€
2 mm	25	PHX2-2	1,80	PHX2-5	1,63	PHX2-50	1,45	PHX2-100	1,40
2,5 mm	25	PHX2,5-2	1,80	PHX2,5-5	1,63	PHX2,5-50	1,45	PHX2,5-100	1,40
3 mm	25	PHX3-2	1,80	PHX3-5	1,63	PHX3-50	1,45	PHX3-100	1,40
4 mm	25	PHX4-2	1,80	PHX4-5	1,63	PHX4-50	1,45	PHX4-100	1,40
5 mm	25	PHX5-2	1,80	PHX5-5	1,63	PHX5-50	1,45	PHX5-100	1,40
6 mm	25	PHX6-2	1,80	PHX6-5	1,63	PHX6-50	1,45	PHX6-100	1,40
8 mm	25	PHX8-2	2,13	PHX8-5	1,93	PHX8-50	1,84	PHX8-100	1,76

TRI
WING

€ x Embout		2 Unités		5 Unités		50 Unités		100 Unités	
	L1 mm		€		€		€		€
N°4	25	PTRW4-2	10,72	PTRW4-5	9,32	PTRW4-50	8,39	PTRW4-100	7,92
N°5	25	PTRW5-2	10,72	PTRW5-5	9,32	PTRW5-50	8,39	PTRW5-100	7,92
N°6	25	PTRW6-2	10,72	PTRW6-5	9,32	PTRW6-50	8,39	PTRW6-100	7,92
N°8	25	PTRW8-2	10,72	PTRW8-5	9,32	PTRW8-50	8,39	PTRW8-100	7,92

XZN



€ x Embout		2 Unités		5 Unités		50 Unités		100 Unités	
	L1 mm		€		€		€		€
N°4	25	PXZN4-2	6,58	PXZN4-5	5,72	PXZN4-50	5,14	PXZN4-100	4,86
N°5	25	PXZN5-2	6,58	PXZN5-5	5,72	PXZN5-50	5,14	PXZN5-100	4,86
N°6	25	PXZN6-2	6,58	PXZN6-5	5,72	PXZN6-50	5,14	PXZN6-100	4,86
N°8	25	PXZN8-2	7,51	PXZN8-5	6,53	PXZN8-50	6,41	PXZN8-100	6,29
N°10	25	PXZN10-2	7,51	PXZN10-5	6,53	PXZN10-50	6,41	PXZN10-100	6,29

EMBOUS DE VISSAGE



50mm
LONGUEUR
TOTALE
(L)



Embouts de vissage

Rose

PHILLIPS



€ x Embout		2 Unités		5 Unités		50 Unités	
	L1 mm		€		€		€
Ph 1	50	Ph1X50-2	2,94	Ph1X50-5	2,56	Ph1X50-50	2,31
Ph 2	50	Ph2X50-2	2,94	Ph2X50-5	2,56	Ph2X50-50	2,31
Ph 3	50	Ph3X50-2	2,94	Ph3X50-5	2,56	Ph3X50-50	2,31
Ph 4	50	Ph4X50-2	-	Ph4X50-5	-	Ph4X50-50	-

POZIDRIV



€ x Embout		2 Unités		5 Unités		50 Unités	
	L1 mm		€		€		€
Pz 1	50	Pz1X50-2	2,94	Pz1X50-5	2,56	Pz1X50-50	2,31
Pz 2	50	Pz2X50-2	2,94	Pz2X50-5	2,56	Pz2X50-50	2,31
Pz 3	50	Pz3X50-2	2,94	Pz3X50-5	2,56	Pz3X50-50	2,31
Pz 4	50	Pz4X50-2	-	Pz4X50-5	-	Pz4X50-50	-

PLAT



€ x Embout		2 Unités		5 Unités		50 Unités	
	L1 mm		€		€		€
0,5X4,0	50	P0,5X4,0X50-2	4,60	P0,5X4,0X50-5	3,99	P0,5X4,0X50-50	3,57
0,5X3,0	50	P0,5X3,0X50-2	4,60	P0,5X3,0X50-5	3,99	P0,5X3,0X50-50	3,57
0,6X3,5	50	P0,6X3,5X50-2	4,60	P0,6X3,5X50-5	3,99	P0,6X3,5X50-50	3,57
0,6X4,5	50	P0,6X4,5X50-2	4,60	P0,6X4,5X50-5	3,99	P0,6X4,5X50-50	3,57
0,8X4,0	50	P0,8X4,0X50-2	4,60	P0,8X4,0X50-5	3,99	P0,8X4,0X50-50	3,57
0,8X5,0	50	P0,8X5,0X50-2	4,60*	P0,8X5,0X50-5	3,99*	P0,8X5,0X50-50	3,57*
0,8X5,5	50	P0,8X5,5X50-2	4,60	P0,8X5,5X50-5	3,99	P0,8X5,5X50-50	3,57
1,0X5,5	50	P1X5,5X50-2	4,60	P1X5,5X50-5	3,99	P1X5,5X50-50	3,57
1,0X6,0	50	P1X6,0X50-2	4,60	P1X6,0X50-5	3,99	P1X6,0X50-50	3,57
1,2X6,5	50	P1,2X6,5X50-2	4,60	P1,2X6,5X50-5	3,99	P1,2X6,5X50-50	3,57
1,2X8,0	50	P1,2X8,0X50-2	4,60	P1,2X8,0X50-5	3,99	P1,2X8,0X50-50	3,57

*jusque fin des stocks

EMBOUS DE VISSAGE



TORX



€ x Embout		2 Unités		5 Unités		50 Unités	
	L1 mm		€		€		€
T 5	50	PT5X50-2	5,88	PT5X50-5	5,12	PT5X50-50	4,63
T 6	50	PT6X50-2	5,88	PT6X50-5	5,12	PT6X50-50	4,63
T 7	50	PT7X50-2	5,88	PT7X50-5	5,12	PT7X50-50	4,63
T 8	50	PT8X50-2	5,88	PT8X50-5	5,12	PT8X50-50	4,63
T 9	50	PT9X50-2	5,88	PT9X50-5	5,12	PT9X50-50	4,63
T 10	50	PT10X50-2	5,42	PT10X50-5	4,90	PT10X50-50	4,24
T 15	50	PT15X50-2	5,42	PT15X50-5	4,90	PT15X50-50	4,24
T 20	50	PT20X50-2	5,42	PT20X50-5	4,90	PT20X50-50	4,24
T 25	50	PT25X50-2	5,42	PT25X50-5	4,90	PT25X50-50	4,24
T 27	50	PT27X50-2	5,42	PT27X50-5	4,90	PT27X50-50	4,24
T 30	50	PT30X50-2	5,42	PT30X50-5	4,90	PT30X50-50	4,24
T 40	50	PT40X50-2	5,42	PT40X50-5	4,90	PT40X50-50	4,24

ROBERTSON



€ x Embout		2 Unités		5 Unités		50 Unités	
	L1 mm		€		€		€
N°1	50	PC1X50-2	7,07	PC1X50-5	6,14	PC1X50-50	5,53
N°2	50	PC2X50-2	7,07	PC2X50-5	6,14	PC2X50-50	5,53
N°3	50	PC3X50-2	7,07	PC3X50-5	6,14	PC3X50-50	5,53

HEXAGONAL



€ x Embout		2 Unités		5 Unités		50 Unités	
	L1 mm		€		€		€
2 mm	50	PHX2X50-2	5,72	PHX2X50-5	4,97	PHX2X50-50	4,48
2,5 mm	50	PHX2,5X50-2	5,72	PHX2,5X50-5	4,97	PHX2,5X50-50	4,48
3 mm	50	PHX3X50-2	5,72	PHX3X50-5	4,97	PHX3X50-50	4,48
4 mm	50	PHX4X50-2	5,72	PHX4X50-5	4,97	PHX4X50-50	4,48
5 mm	50	PHX5X50-2	5,72	PHX5X50-5	4,97	PHX5X50-50	4,48
6 mm	50	PHX6X50-2	5,72	PHX6X50-5	4,97	PHX6X50-50	4,48
8 mm	50	PHX8X50-2	7,33	PHX8X50-5	6,71	PHX8X50-50	5,74

EMBOUS DE VISSAGE

Embouts de vissage
Rose



70mm
LONGUEUR
TOTALE
(L.)



PHILLIPS



€ x Embout

2 Unités

5 Unités

	L1 mm		€		€
Ph 1	70	Ph1X70-2	6,90	Ph1X70-5	6,01
Ph 2	70	Ph2X70-2	6,90	Ph2X70-5	6,01
Ph 3	70	Ph3X70-2	6,90	Ph3X70-5	6,01
Ph 4	70	Ph4X70-2	-	Ph4X70-5	-

POZIDRIV



€ x Embout

2 Unités

5 Unités

	L1 mm		€		€
Pz 1	70	Pz1X70-2	6,90	Pz1X70-5	6,01
Pz 2	70	Pz2X70-2	6,90	Pz2X70-5	6,01
Pz 3	70	Pz3X70-2	6,90	Pz3X70-5	6,01
Pz 4	70	Pz4X70-2	-	Pz4X70-5	-



90mm
LONGUEUR
TOTALE
(L.)



PHILLIPS



€ x Embout

2 Unités

5 Unités

	L1 mm		€		€
Ph 1	90	Ph1X90-2	8,51	Ph1X90-5	7,40
Ph 2	90	Ph2X90-2	8,51	Ph2X90-5	7,40
Ph 3	90	Ph3X90-2	8,51	Ph3X90-5	7,40
Ph 4	90	Ph4X90-2	-	Ph4X90-5	-

POZIDRIV



€ x Embout

2 Unités

5 Unités

	L1 mm		€		€
Pz 1	90	Pz1X90-2	8,51	Pz1X90-5	7,40
Pz 2	90	Pz2X90-2	8,51	Pz2X90-5	7,40
Pz 3	90	Pz3X90-2	8,51	Pz3X90-5	7,40
Pz 4	90	Pz4X90-2	-	Pz4X90-5	-

EMBOUS DE VISSAGE

TiN

25mm
LONGUEUR
TOTALE
(L)

PHILLIPS



€ x Embout		2 Unités		5 Unités		50 Unités	
	L1 mm		€		€		€
Ph 1	25	Ph1T-2	3,48	Ph1T-5	2,62	Ph1T-50	2,36
Ph 2	25	Ph2T-2	3,48	Ph2T-5	2,62	Ph2T-50	2,36
Ph 3	25	Ph3T-2	3,48	Ph3T-5	2,62	Ph3T-50	2,36

POZIDRIV



€ x Embout		2 Unités		5 Unités		50 Unités	
	L1 mm		€		€		€
Pz 1	25	Pz1T-2	3,48	Pz1T-5	2,62	Pz1T-50	2,36
Pz 2	25	Pz2T-2	3,48	Pz2T-5	2,62	Pz2T-50	2,36
Pz 3	25	Pz3T-2	3,48	Pz3T-5	2,62	Pz3T-50	2,36

PLAT



€ x Embout		2 Unités		5 Unités		50 Unités	
	L1 mm		€		€		€
0,6X4,5	25	P0,6X4,5T-2	3,72	P0,6X4,5T-5	3,23	P0,6X4,5T-50	2,90
0,8X5,5	25	P0,8X5,5T-2	3,72	P0,8X5,5T-5	3,23	P0,8X5,5T-50	2,90
1,0X5,5	25	P1X5,5T-2	3,72	P1X5,5T-5	3,23	P1X5,5T-50	2,90
1,2X6,5	25	P1,2X6,5T-2	3,72	P1,2X6,5T-5	3,23	P1,2X6,5T-50	2,90

TORX



€ x Embout		2 Unités		5 Unités		50 Unités	
	L1 mm		€		€		€
T 10	25	PT10T-2	3,66	PT10T-5	3,19	PT10T-50	2,87
T 15	25	PT15T-2	3,66	PT15T-5	3,19	PT15T-50	2,87
T 20	25	PT20T-2	3,66	PT20T-5	3,19	PT20T-50	2,87
T 25	25	PT25T-2	3,66	PT25T-5	3,19	PT25T-50	2,87
T 27	25	PT27T-2	3,66	PT27T-5	3,19	PT27T-50	2,87
T 30	25	PT30T-2	3,66	PT30T-5	3,19	PT30T-50	2,87
T 40	25	PT40T-2	3,66	PT40T-5	3,19	PT40T-50	2,87

EMBOUS DE VISSAGE

TiN



50mm
LONGUEUR
TOTALE
(L)



PHILLIPS



€ x Embout		2 Unités		5 Unités		50 Unités	
	L1 mm		€		€		€
Ph 1	50	Ph1Tx50-2	8,01	Ph1Tx50-5	6,97	Ph1Tx50-50	6,25
Ph 2	50	Ph2Tx50-2	8,01	Ph2Tx50-5	6,97	Ph2Tx50-50	6,25
Ph 3	50	Ph3Tx50-2	8,01	Ph3Tx50-5	6,97	Ph3Tx50-50	6,25

POZIDRIV



€ x Embout		2 Unités		5 Unités		50 Unités	
	L1 mm		€		€		€
Pz 1	50	Pz1Tx50-2	8,01	Pz1Tx50-5	6,97	Pz1Tx50-50	6,25
Pz 2	50	Pz2Tx50-2	8,01	Pz2Tx50-5	6,97	Pz2Tx50-50	6,25
Pz 3	50	Pz3Tx50-2	8,01	Pz3Tx50-5	6,97	Pz3Tx50-50	6,25

TORX



€ x Embout		2 Unités		5 Unités		50 Unités	
	L1 mm		€		€		€
T 10	50	PT10Tx50-2	11,36	PT10Tx50-5	9,87	PT10Tx50-50	8,87
T 15	50	PT15Tx50-2	11,36	PT15Tx50-5	9,87	PT15Tx50-50	8,87
T 20	50	PT20Tx50-2	11,36	PT20Tx50-5	9,87	PT20Tx50-50	8,87
T 25	50	PT25Tx50-2	11,36	PT25Tx50-5	9,87	PT25Tx50-50	8,87
T 27	50	PT27Tx50-2	11,36	PT27Tx50-5	9,87	PT27Tx50-50	8,87
T 30	50	PT30Tx50-2	11,36	PT30Tx50-5	9,87	PT30Tx50-50	8,87
T 40	50	PT40Tx50-2	11,36	PT40Tx50-5	9,87	PT40Tx50-50	8,87

PORTE-EMBOUTS

PORTE-EMBOUTS MAGNÉTIQUES

	L1 mm	TYPE DE QUEUE	€
PMGx51	51	MAGNÉTIQUE SANS ANNEAU	6,63
PMGx58	58	MAGNÉTIQUE SANS ANNEAU	6,80
PMGx74	74	MAGNÉTIQUE AVEC ANNEAU	11,74
PMGx100	100	MAGNÉTIQUE AVEC ANNEAU	13,56
PMGx150	150	MAGNÉTIQUE AVEC ANNEAU	16,28
PMGx200	200	MAGNÉTIQUE AVEC ANNEAU	17,88
PMGx250	250	MAGNÉTIQUE AVEC ANNEAU	27,49
PMGSDSx78	78	SDS PLUS	20,03
PBERx74	74	BÉRYLIUM	50,41 *
PDESSx70	70	5/16" DESSOUTTER	31,06 *
P7x74	74	7mm Fein	33,75 *

*jusque fin des stocks



PORTE-EMBOUTS MAGNÉTIQUES À CHANGEMENT RAPIDE (VALABLE POUR EMBOUTS DE 1/4" À COU)

	L1 mm	TYPE DE QUEUE	€
PCRX60	60	Changement rapide 1/4" Valable pour embouts 1/4"	17,45
PCRX74	74	Changement rapide 1/4" Valable pour embouts 1/4"	18,00
PCRSDSX80	80	SDS PLUS	29,21



PORTE-EMBOUTS MAGNÉTIQUES AVEC ANNEAU FRONTAL MAGNÉTIQUE SUPPLÉMENTAIRE POUR LE MAINTIEN DES VIS

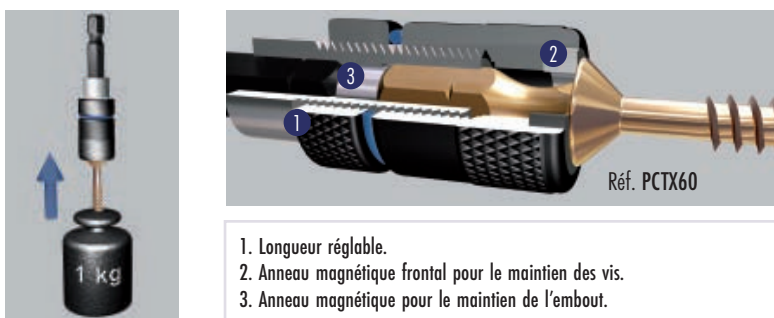

1. Longueur réglable.
2. Anneau magnétique frontal pour le maintien des vis.
3. Anneau magnétique pour le maintien de l'embout.

	L1 mm	TYPE PORTE-EMBOUTS	€
PCTX60	60	Avec butoir réglable	16,44



DOUILLES HEXAGONALES MAGNÉTIQUES



DOUILLE HEXAGONALE MAGNÉTIQUE



	mm	"		€/IU.
PLHX5-2	5,0		2	6,41
PLHX5,5-2	5,5		2	6,41
PLHX6-2	6,0		2	6,41
PLHX1/4-2		1/4"=6,35	2	6,41
PLHX7-2	7,0		2	6,57
PLHX5/16-2		5/16"=7,93	2	6,57
PLHX8-2	8,0		2	6,57
PLHX3/8-2		3/8"=9,52	2	6,57
PLHX10-2	10,0		2	6,71
PLHX11-2	11,0		2	6,71
PLHX12-2	12,0		2	6,84
PLHX13-2	13,0		2	6,90

COFFRET DE 7 DOUILLES HEXAGONALES

RÉFÉRENCE N° DOUILLE	EPLL
	7
CONTENU	HX1/4 - HX7 - HX8 - HX3/8 HX10 - HX12 - HX13
PRIX €	46,19



TOURNEVIS À CLIQUET AVEC MAGASIN POUR EMBOUTS

Plus

1. Haute qualité et rendement
2. Visse à droite et à gauche
3. Tige télescopique ajustable en longueur
4. Fabriqué en acier et plastique haute résistance

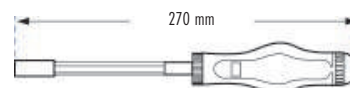
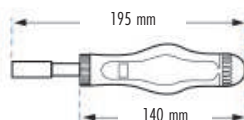

DTRC

- Contenu du tournevis
- PH1 - PH2
 - PZ1 - PZ2
 - T15 - T20 - T25 - T30

35,10 €

COFFRETS D'EMBOUS DE VISSAGE

COFFRETS DE 7 PIÈCES QUALITÉ PLUS ET TiN



Réf. EPT1

RÉFÉRENCE N° EMBOUTS	EPT1	EPT2	EPT3
CONTENU	PH1 - PH2 PZ1 - PZ2 0,8x5,5 - 1,2x6,5 1 Porte-embouts PMG	T10 - T15 T20 - T25 T30 - T40 1 Porte-embouts PMG	PH1 - PH2 - PH3 PZ1 - PZ2 - PZ3 1 Porte-embouts PMG
PRIX €	12,20	16,45	14,64



Réf. EPTT1

RÉFÉRENCE N° EMBOUTS	EPTT1	EPTT2	EPTT3
CONTENU	PH1 - PH2 PZ1 - PZ2 0,8x5,5 - 1,2x6,5 1 Porte-embouts PMG	T10 - T15 T20 - T25 T30 - T40 1 Porte-embouts PMG	PH1 - PH2 - PH3 PZ1 - PZ2 - PZ3 1 Porte-embouts PMG
PRIX €	34,64	40,16	33,41

COFFRETS D'EMBOUS DE VISSAGE

COFFRETS DE 12 PIÈCES QUALITÉ PLUS ET TiN



Réf. EPT4

RÉFÉRENCE
N° EMOUS

CONTENU



EPT4	
N° EMOUS	12
+	PH1 - PH2(2) - PH3
+	PZ1 - PZ2(2) - PZ3
-	0,6x4,5 - 0,8x5,5 - 1,2x6,5
1 Porte-embouts PMG	

PRIX €

16,38

EPT5

12

T10 - T15(2)
★ T20(2) - T25(2)
T27 - T30(2) - T40
1 Porte-embouts PMG

22,49



Réf. EPTT4

RÉFÉRENCE
N° EMOUS

CONTENU



EPTT4	
N° EMOUS	12
+	PH1 - PH2(2) - PH3
+	PZ1 - PZ2(2) - PZ3
-	0,6x4,5 - 0,8x5,5 - 1,2x6,5
1 Porte-embouts PCT	

PRIX €

43,61

EPTT5

12

T10 - T15(2)
★ T20(2) - T25(2)
T27 - T30(2) - T40
1 Porte-embouts PCT

51,32

COFFRETS DE 31 PIÈCES QUALITÉ PLUS ET TiN



Réf. EPT6

RÉFÉRENCE
N° EMOUS

CONTENU



EPT6	
N° EMOUS	31
+	PH1(3) - PH2(3) - PH3(3)
+	PZ1(3) - PZ2(3) - PZ3(3)
-	0,6x4,5 - 0,8x5,5 - 1,2x6,5
★	T10 - T15 - T20 - T25 - T30 - T40
○	H3 - H4 - H5
1 Porte-embouts PMG	

PRIX €

46,81

RÉFÉRENCE
N° EMOUS

CONTENU

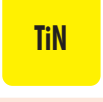

EPTT6	
N° EMOUS	31
+	PH1(3) - PH2(3) - PH3(3)
+	PZ1(3) - PZ2(3) - PZ3(3)
-	0,6x4,5 - 0,8x5,5 - 1,2x6,5
★	T10 - T15 - T20 - T25 - T30 - T40
○	H3 - H4 - H5
1 Porte-embouts PCT	

PRIX €

99,32

COFFRETS DE 36 PIÈCES QUALITÉ PLUS ET TiN



Réf. EPT7

RÉFÉRENCE
N° EMOUS

CONTENU



EPT7	
N° EMOUS	36
+	PH1(3) - PH2(3) - PH3(3)
+	PZ1(3) - PZ2(3) - PZ3(3)
-	0,5 x 4 - 0,6 x 4,5 - 0,8 x 5 - 0,8 x 5,5 - 1 x 6 - 1,2 x 6,5 - 1,2 x 8
★	T10 - T15 - T20 - T25 - T27 - T30 - T40
○	H2 - H2,5 - H3 - H4 - H5 - H6 - H8
1 Porte-embouts PMG	

PRIX €

59,28



Réf. EPTT7

RÉFÉRENCE
N° EMOUS

CONTENU



EPTT7*	
N° EMOUS	36
+	PH1(3) - PH2(3) - PH3(3)
+	PZ1(3) - PZ2(3) - PZ3(3)
-	0,5 x 4 - 0,6 x 4,5 - 0,8 x 5 - 0,8 x 5,5 - 1 x 6 - 1,2 x 6,5 - 1,2 x 8
★	T10 - T15 - T20 - T25 - T27 - T30 - T40
○	H2 - H2,5 - H3 - H4 - H5 - H6 - H8
1 Porte-embouts PCT	

PRIX €

121,63*

*jusque fin des stocks

COFFRETS D'EMBOUS DE VISSAGE

COFFRETS DE 45 ET 80 PIÈCES QUALITÉ *Plus*

Embout de vissage
Rose



Réf. EPT45



Réf. EPT80

RÉFÉRENCE	EPT45	
N° EMBOUTS	45	
CONTENU	<ul style="list-style-type: none"> PH1(2) - PH2(2) - PH3(2) PZ1(2) - PZ2(2) - PZ3(2) 0,5x3-0,6x4,5-0,8x5,5(2)-1,2x6,5-1,6x8 H2,5 - H3 - H4 - H5 - H6 - H7 T10 - T15 - T20 - T25 - T30 - T40 	<ul style="list-style-type: none"> Douilles Hexagonales (mm): 5 - 6 - 7 - 8 - 9 - 10 - 11 - 12 - 13 - 14 1 Adaptateur pour douilles 1 Adaptateur pour Embouts 1 Porte-embouts Magnétique PCR 1 Clé à Cliquet de 72 dents 1 Tournevis
PRIX €	148,32	



RÉFÉRENCE	EPT80*	
N° EMBOUTS	80	
CONTENU	<ul style="list-style-type: none"> PH0 - PH1 - PH2(4) - PH3(2) PZ1 - PZ2(4) - PZ3(2) 0,5x3-0,6x4,5-0,8x5,5(2)-1,2x6,5-1,6x8 H2 - H2,5 - H3 - H4 - H5 - H6 - H7 - H8 TW1 - TW2 - TW3 - TW4 - TW5 TQ5 - TQ6 - TQ8 - TQ10 T5 - T6 - T7 - T8 - T9 - T10 - T15 T20(2) - T25(2) - T27 - T30 - T40 TS10 - TS15 - TS20 - TS25 - TS30 - TS40 	<ul style="list-style-type: none"> C0 - C1 - C2 - C3 SP4 - SP6 - SP8 - SP10 HS3 - HS4 - HS5 - HS6 1 Porte-Embouts PCR 1 Tournevis PH1 - PH2 PZ1 - PZ2 T15 - T20 - T25 - T30
PRIX €	155,24*	

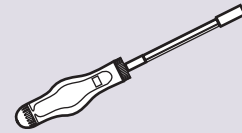

*jusque fin des stocks

EXTRACTEURS MACHINE POUR VIS CASSÉES

MICRO GRABIT

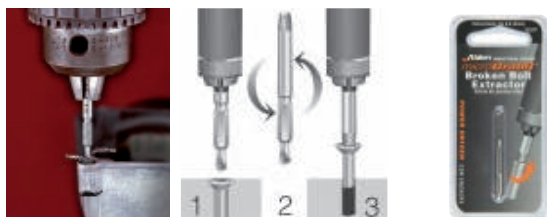

		EP
		€
EP451C	M3	55,10
EP452C	M4	55,10
EP453C	M5	55,10
EP454C	M6	55,10

1. Percer la vis
2. Retourner
3. Extraire

PRO GRABIT À CORPS HEXAGONAL 1/4"

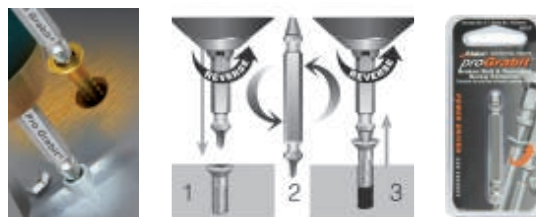

		EP
		€
EP8401C	M5	43,70
EP8402C	M6	51,63
EP8403C	M8	51,63
EP8404C	M10	54,18

1. Percer la vis
2. Retourner
3. Extraire

DRILL-OUT EXTRACTEUR AVEC FORET PILOTE (M6-M12)

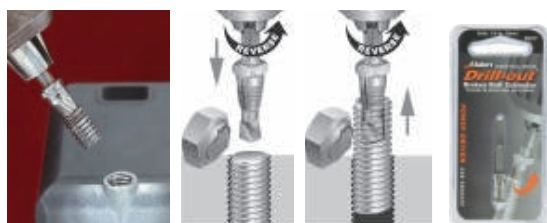

		EP
		€
EP205C	M6	53,42
EP312C	M8	64,73
EP375C	M10	64,73
EP500C	M12	72,86

X-OUT EXTRACTEUR À QUEUE HEXAGONALE (M3-M5)



		EP
		€
EP3701C	M3	43,70
EP3702C	M4	43,70
EP3703C	M5	48,57

COFFRETS D'EXTRACTEURS MACHINE POUR VIS CASSÉES

MICRO GRABIT

RÉFÉRENCE	EP450C
N° PIÈCES	4
CONTENU	M3-M4-M5-M6
PRIX €	226,00



MICRO GRABIT

RÉFÉRENCE	EP401C
N° PIÈCES	4
CONTENU	M6-M8-M10-M12
PRIX €	265,87



EXTRACTEURS DE VIS À MAIN

JEUX D'EXTRACTEURS CLASSIQUES DE VIS

Faire un trou central avec le foret BLUE-MASTER recommandé.
Introduire l'extracteur dans le trou, tourner l'extracteur vers la gauche, jusqu'à extraction de la vis.

RÉFÉRENCE	EX/1-5	EX/1-6	EX/1-8
N° PIÈCES	5	6	8
CONTENU	M3 - M18	M3 - M24	M3 - M45
PRIX €	23,38	31,64	73,03



Réf. EX/1-6

Emboutis de vissage

Rose



	Pour VIS	mm	mm	L1 mm	Ø min mm	Ø max. mm	EX €
EX/1	M3 - M6	3,2	2,5	51	1,75	3,95	2,86
EX/2	M6 - M8	4,0	3,0	60	2,20	4,80	2,86
EX/3	M8 - M11	5,1	4,5	68	3,30	6,40	3,38
EX/4	M11 - M14	6,2	6,0	76	4,75	8,40	4,20
EX/5	M14 - M18	8,6	8,0	86	6,35	11,00	5,43
EX/6	M18 - M24	12,0	11,0	95	9,50	15,00	9,20
EX/7	M24 - M33	15,9	14,0	105	12,70	19,00	24,92
EX/8	M33 - M45	20,0	21,0	111	19,00	25,00	40,82



RÉFÉRENCE	EXTT
N° PIÈCES	10
EXTRACTEURS	EX/1-EX/2-EX/3-EX/4-EX/5
FORETS AVANT-TROUS	Réf. BC3 Ø2,5-3-4-5-6-8
PRIX €	38,27

EXTRACTEURS DE VIS À MAIN



	Pour VIS	mm	mm	L1 mm	Ø min mm	Ø max. mm	EFX €
EFX/1	M3-M6	2,9	2,0	50	1,9	3,2	3,60
EFX/2	M6-M8	3,9	3,2	60	2,8	5,0	3,60
EFX/3	M8-M11	4,8	4,0	68	3,2	6,5	4,26
EFX/4	M11-M14	6,7	6,4	75	5,2	9,0	5,29
EFX/5	M14-M18	8,5	7,1	85	6,4	11,0	6,89
EFX/6	M18-M25	11,8	9,5	95	9,4	15,0	11,64
EFX/7	M25-M35	14,3	12,7	106	12,8	19,0	31,53
EFX/8	M35-M45	19,5	19,5	110	19,3	25,0	51,65



Réf. EFX/1-5

RÉFÉRENCE	EFX/1-5
N° PIÈCES	5
CONTENU	M3 - M18
PRIX €	27,62

FORETS POUR MÉTAUX DIN 338

Réf. BH2

HSS



OX



	Ø mm	L1 x L2 mm	mm	BH2 €
BH20200	2,00	61 x 33	1/4"	6,26
BH20300	3,00	61 x 33	1/4"	6,26
BH20400	4,00	75 x 43	1/4"	6,50
BH20500	5,00	86 x 52	1/4"	8,09
BH20600	6,00	93 x 57	1/4"	8,73
BH20700	7,00	109 x 69	1/4"	10,99
BH20800	8,00	117 x 75	1/4"	12,35
BH20900	9,00	125 x 81	1/4"	13,89
BH21000	10,00	133 x 87	1/4"	15,46



RÉFÉRENCE	BH29335	BH29333
N° FORETS	5	8
QUALITÉ	HSS	HSS
CONTENU	Ø 3-4-5-6-8 mm	Ø 3-4-5-6-7-8-9-10 mm
PRIX €	53,15	71,10

OUTILS À QUEUE HEXAGONALE DE 1/4"

FORETS POUR MÉTAUX EXTRA-COURT

HSS-G

Réf. BC59

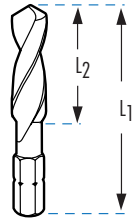

FORET-TARAUD À CHANFREINER

HSS-G

Réf. MAHM

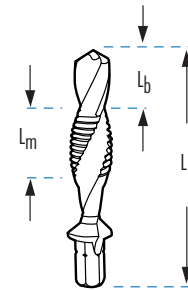

	Ø mm	L1 x L2 mm		BC59 €	BC59CR €
BC590100	1,00	34 x 12	1/4"	6,75	-
BC590150	1,50	34 x 12	1/4"	6,75	-
BC590200	2,00	34 x 12	1/4"	6,75	6,75
BC590250	2,50	36 x 14	1/4"	6,75	6,75
BC590300	3,00	38 x 16	1/4"	6,75	6,75
BC590330	3,30	40 x 18	1/4"	6,75	6,75
BC590350	3,50	40 x 18	1/4"	6,75	6,75
BC590400	4,00	44 x 20	1/4"	6,75	6,75
BC590420	4,20	45 x 20	1/4"	6,75	6,75
BC590450	4,50	46 x 24	1/4"	6,75	6,75
BC590500	5,00	50 x 26	1/4"	6,75	6,75
BC590550	5,50	50 x 26	1/4"	7,06	7,06
BC590600	6,00	50 x 26	1/4"	7,06	7,06
BC590650	6,50	50 x 30	1/4"	7,06	7,06
BC590680	6,80	50 x 30	1/4"	7,06	7,06
BC590700	7,00	50 x 30	1/4"	7,06	7,06
BC590750	7,50	51 x 32	1/4"	8,24	8,24
BC590800	8,00	51 x 32	1/4"	8,24	8,24
BC590850	8,50	53 x 33	1/4"	8,24	8,24
BC590900	9,00	53 x 33	1/4"	9,49	9,49
BC590950	9,50	54 x 38	1/4"	9,49	9,49
BC591000	10,00	54 x 38	1/4"	9,49	9,49
BC591020	10,20	54 x 38	1/4"	9,49	9,49

	L1 x Lb x Lm mm		MAHM €	MAHMCR €
M 3 x 0,50	36 x 5 x 6	1/4"	18,51	18,51
M 4 x 0,70	39 x 6 x 7	1/4"	18,51	18,51
M 5 x 0,80	41 x 8 x 8	1/4"	18,51	18,51
M 6 x 1,00	44 x 8 x 10	1/4"	18,51	18,51
M 8 x 1,25	50 x 10 x 11	1/4"	25,60	25,60
M 10 x 1,50	59 x 11 x 11	1/4"	30,87	30,87



RÉFÉRENCE	MAH9327CR
N° FORETS	5
RÉFÉRENCE FORET	MAHMCR
CONTENU	M4-M5-M6-M8-M10
PRIX €	130,52

TARAUDS HSS-G

HSS-G

Réf. M

	L1 x L2 mm		M €	MCR €
M 3 x 0,50	33 x 11	1/4"	7,10	7,10
M 4 x 0,70	35 x 12	1/4"	7,10	7,10
M 5 x 0,80	36 x 15	1/4"	9,04	9,04
M 6 x 1,00	39 x 18	1/4"	9,04	9,04
M 8 x 1,25	40 x 19	1/4"	12,53	12,53
M 10 x 1,50	41 x 21	1/4"	15,47	15,47

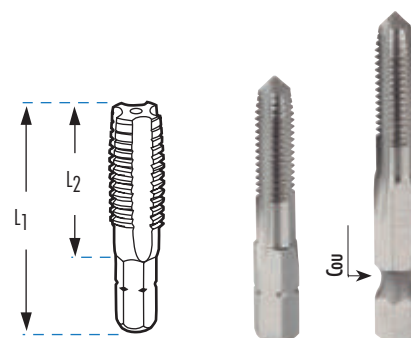

OUTILS À QUEUE HEXAGONALE DE 1/4"

FORET-TARAUD HSSCo STEP CUT

NEW
Réf. MTKM

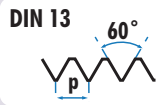

HSSCo
5%

BRILLANT

TOL
6H

D
QUEUE
DÉGAGÉE

1/4"

STEP CUT

										MTKM
		Lb mm	Lm mm	L3 mm	L mm	Db mm	D2 mm	D3 mm	Hexagon	€
M	3x0,50	D 7,0	6,0	6,0	57,0	2,5	2,2	7,3	1/4"	21,29
M	4x0,70	D 7,0	8,5	6,0	62,0	3,3	3,0	7,3	1/4"	21,29
M	5x0,80	D 9,0	10,0	6,0	69,0	4,2	3,7	7,3	1/4"	21,29
M	6x1,00	D 10,0	12,0	6,0	73,0	5,0	4,5	7,3	1/4"	21,29
M	8x1,25	D 12,0	16,0	6,0	87,0	6,8	6,3	9,4	1/4"	29,44
M	10x1,50	D 14,0	20,0	6,0	96,0	8,5	8,0	11,4	1/4"	35,50
M	12x1,75	D 16,0	24,0	8,0	112,0	10,3	9,8	13,4	1/4"	56,36

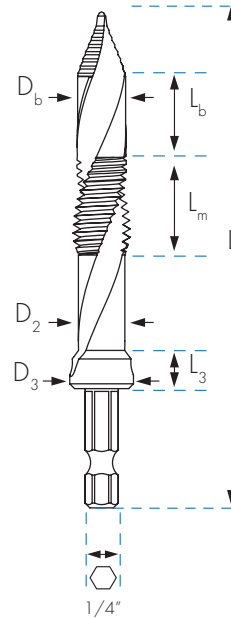

Embout de vissage
Rose

FRAISES À CHANFREINER 3 GOUJURES

HSS-G

Réf. AV22

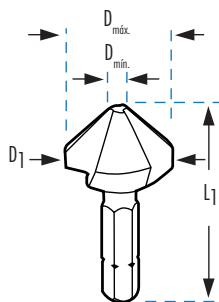

FRAISES À ÉBAVURER

HSS



1/4"

Réf. AV1...CR

Réf. AV101CR
Réf. AV102CR



Réf. AV103CR
Réf. AV104CR

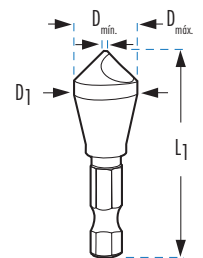

AV22				
D1 mm	L1 mm	D min. - D max. mm	Hexagon	€
6,30	31	1,50 - 5,8	1/4"	17,85
8,30	31	2,00 - 7,8	1/4"	17,85
10,40	34	2,50 - 10,0	1/4"	19,14
12,40	35	2,80 - 12,0	1/4"	20,41
16,50	40	3,20 - 16,0	1/4"	22,83
20,50	41	3,50 - 20,0	1/4"	25,06

AV1...CR					
	D1 mm	L1 mm	D min. - D max. mm	Hexagon	€
AV101CR	10,00	40	2,0 - 5,0	1/4"	18,09
AV102CR	14,00	42	5,0 - 10,0	1/4"	22,62
AV103CR	17,00	45	5,0 - 13,0	1/4"	40,50
AV104CR	25,00	55	7,0 - 20,0	1/4"	72,32

OUTILS À QUEUE HEXAGONALE DE 1/4"

FORETS BÉTON PROFESSIONNELS

Réf. BWH

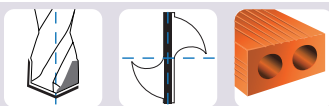

	Ø mm	L1 x L2 mm		BWH €
BWH03	3	70 x 30	1/4"	3,16
BWH04	4	70 x 30	1/4"	3,42
BWH05	5	85 x 45	1/4"	3,71
BWH06	6	100 x 50	1/4"	4,14
BWH07	7	100 x 50	1/4"	4,85
BWH08	8	120 x 70	1/4"	5,63
BWH09	9	120 x 70	1/4"	6,71
BWH10	10	120 x 70	1/4"	7,53
BWH11	11	150 x 80	1/4"	9,37
BWH12	12	150 x 80	1/4"	10,59
BWH13	13	150 x 80	1/4"	13,02
BWH14	14	150 x 80	1/4"	15,16

MÈCHES À BOIS

Réf. BMH

CV



	Ø mm	L1 x L2 mm		BMH €
BMH03	3	59 x 35	1/4"	2,02
BMH04	4	74 x 41	1/4"	2,14
BMH05	5	82 x 55	1/4"	2,11
BMH06	6	88 x 58	1/4"	2,85
BMH07	7	110 x 70	1/4"	3,22
BMH08	8	110 x 70	1/4"	3,37
BMH09	9	110 x 70	1/4"	3,50
BMH10	10	115 x 75	1/4"	3,87
BMH11	11	135 x 85	1/4"	4,52
BMH12	12	135 x 85	1/4"	5,29
BMH13	13	135 x 90	1/4"	8,28
BMH14	14	145 x 95	1/4"	10,32



RÉFÉRENCE	BWH9318	BWH9327	BWH9319	BMH9335	BMH9333
N° FORETS	5	5	8	5	8
APPLICATION	BÉTON	BÉTON	BÉTON	BOIS	BOIS
CONTENU	Ø 3 - 4 - 5 - 6 - 8 mm	Ø 4 - 5 - 6 - 8 - 10 mm	Ø 3 - 4 - 5 - 6 - 7 - 8 - 9 - 10 mm	Ø 3 - 4 - 5 - 6 - 8 mm	Ø 3 - 4 - 5 - 6 - 7 - 8 - 9 - 10 mm
PRIX €	27,28	32,92	37,70	16,93	22,33

COFFRETS D'OUTILS À QUEUE HEXAGONALE DE 1/4"



Réf. EB



Réf. EMBP

CONTENU

	HSS-G	HSS-G			€
EM	M3 - M4 - M5 - M6 M8 - M10	-	-	-	58,67
EMBP	M3 - M4 - M5 - M6 M8 - M10	Ø 2,50 - 3,30 - 4,20 5 - 6,80 - 8,50	-	-	94,86
EBM	-	-	M3 - M4 - M5 - M6 M8 - M10	-	124,26
EA	-	-	-	Ø 6,30 - 8,30 - 10,40 12,40 - 16,50 - 20,50	119,82
EB	-	Ø 1 - 10 mm x 0,50	-	-	131,42