

BLUE-MASTER[®]
by *ce/esa*



1/4" SHANK
TOOLS

INTERCHANGEABLE SCREWDRIVER BITS



PHILLIPS



€ per Bit

2 U

5 U

50 U

100 U

	L1 mm		€		€		€		€
Ph 0	25	Ph0-2	1,55	Ph0-5	1,36	Ph0-50	1,21	Ph0-100	1,16
Ph 1	25	Ph1-2	1,30	Ph1-5	0,81	Ph1-50	0,73	Ph1-100	0,68
Ph 2	25	Ph2-2	1,30	Ph2-5	0,81	Ph2-50	0,73	Ph2-100	0,68
Ph 3	25	Ph3-2	1,30	Ph3-5	0,81	Ph3-50	0,73	Ph3-100	0,68

POZIDRIV



€ per Bit

2 U

5 U

50 U

100 U

	L1 mm		€		€		€		€
Pz 0	25	Pz0-2	1,55	Pz0-5	1,36	Pz0-50	1,21	Pz0-100	1,16
Pz 1	25	Pz1-2	1,30	Pz1-5	0,81	Pz1-50	0,73	Pz1-100	0,68
Pz 2	25	Pz2-2	1,30	Pz2-5	0,81	Pz2-50	0,73	Pz2-100	0,68
Pz 3	25	Pz3-2	1,30	Pz3-5	0,81	Pz3-50	0,73	Pz3-100	0,68

SLOT



€ per Bit

2 U

5 U

50 U

100 U

	L1 mm		€		€		€		€
0,5X3,0	25	P0,5X3,0-2	1,76	P0,5X3,0-5	1,52	P0,5X3,0-50	1,38	P0,5X3,0-100	1,31
0,6X3,5	25	P0,6X3,5-2	1,76	P0,6X3,5-5	1,52	P0,6X3,5-50	1,38	P0,6X3,5-100	1,31
0,5X4,0	25	P0,5X4,0-2	1,76	P0,5X4,0-5	1,52	P0,5X4,0-50	1,38	P0,5X4,0-100	1,31
0,6X4,5	25	P0,6X4,5-2	1,76	P0,6X4,5-5	1,52	P0,6X4,5-50	1,38	P0,6X4,5-100	1,31
0,8X4,0	25	P0,8X4,0-2	1,76	P0,8X4,0-5	1,52	P0,8X4,0-50	1,38	P0,8X4,0-100	1,31
0,8X5,0	25	P0,8X5,0-2	1,76	P0,8X5,0-5	1,52	P0,8X5,0-50	1,38	P0,8X5,0-100	1,31
0,8X5,5	25	P0,8X5,5-2	1,76	P0,8X5,5-5	1,52	P0,8X5,5-50	1,38	P0,8X5,5-100	1,31
1,0X5,5	25	P1X5,5-2	1,76	P1X5,5-5	1,52	P1X5,5-50	1,38	P1X5,5-100	1,31
1,0X6,0	25	P1X6,0-2	1,76	P1X6,0-5	1,52	P1X6,0-50	1,38	P1X6,0-100	1,31
1,2X6,5	25	P1,2X6,5-2	1,76	P1,2X6,5-5	1,52	P1,2X6,5-50	1,38	P1,2X6,5-100	1,31
1,2X8,0	25	P1,2X8,0-2	1,76	P1,2X8,0-5	1,52	P1,2X8,0-50	1,38	P1,2X8,0-100	1,31

INTERCHANGEABLE SCREWDRIVER BITS



25mm
OVERALL
LENGTH
(L)



Screwdriver bits

Pink

TORX



€ per Bit		2 U		5 U		50 U		100 U	
	L1 mm		€		€		€		€
T5	25	PT5-2	2,32	PT5-5	2,01	PT5-50	1,82	PT5-100	1,72
T6	25	PT6-2	2,32	PT6-5	2,01	PT6-50	1,82	PT6-100	1,72
T7	25	PT7-2	2,32	PT7-5	2,01	PT7-50	1,82	PT7-100	1,72
T8	25	PT8-2	2,32	PT8-5	2,01	PT8-50	1,82	PT8-100	1,72
T9	25	PT9-2	2,32	PT9-5	2,01	PT9-50	1,82	PT9-100	1,72
T10	25	PT10-2	1,91	PT10-5	1,49	PT10-50	1,33	PT10-100	1,26
T15	25	PT15-2	1,91	PT15-5	1,49	PT15-50	1,33	PT15-100	1,26
T20	25	PT20-2	1,91	PT20-5	1,49	PT20-50	1,33	PT20-100	1,26
T25	25	PT25-2	1,91	PT25-5	1,49	PT25-50	1,33	PT25-100	1,26
T27	25	PT27-2	1,91	PT27-5	1,49	PT27-50	1,33	PT27-100	1,26
T30	25	PT30-2	1,91	PT30-5	1,49	PT30-50	1,33	PT30-100	1,26
T40	25	PT40-2	1,91	PT40-5	1,49	PT40-50	1,33	PT40-100	1,26

**TORX
ROUND**



€ per Bit		2 U		5 U		50 U		100 U	
	L1 mm		€		€		€		€
TR10	25	PTR10-2	6,17	PTR10-5	5,36	PTR10-50	4,84	PTR10-100	4,55
TR15	25	PTR15-2	6,17	PTR15-5	5,36	PTR15-50	4,84	PTR15-100	4,55
TR20	25	PTR20-2	6,17	PTR20-5	5,36	PTR20-50	4,84	PTR20-100	4,55
TR25	25	PTR25-2	6,17	PTR25-5	5,36	PTR25-50	4,84	PTR25-100	4,55
TR30	25	PTR30-2	6,17	PTR30-5	5,36	PTR30-50	4,84	PTR30-100	4,55
TR40	25	PTR40-2	6,17	PTR40-5	5,36	PTR40-50	4,84	PTR40-100	4,55

ROBERTSON



€ per Bit		2 U		5 U		50 U		100 U	
	L1 mm		€		€		€		€
Nº1	25	PC1-2	2,48	PC1-5	2,17	PC1-50	1,95	PC1-100	1,84
Nº2	25	PC2-2	2,48	PC2-5	2,17	PC2-50	1,95	PC2-100	1,84
Nº3	25	PC3-2	2,48	PC3-5	2,17	PC3-50	1,95	PC3-100	1,84

INTERCHANGEABLE SCREWDRIVER BITS

**TORX
SECURITY**

€ per Bit
2 U
5 U
50 U
100 U

	L1 mm		€		€		€		€
TS10	25	PTS10-2	3,31	PTS10-5	2,87	PTS10-50	2,59	PTS10-100	2,44
TS15	25	PTS15-2	3,31	PTS15-5	2,87	PTS15-50	2,59	PTS15-100	2,44
TS20	25	PTS20-2	3,31	PTS20-5	2,87	PTS20-50	2,59	PTS20-100	2,44
TS25	25	PTS25-2	3,31	PTS25-5	2,87	PTS25-50	2,59	PTS25-100	2,44
TS27	25	PTS27-2	3,31	PTS27-5	2,87	PTS27-50	2,59	PTS27-100	2,44
TS30	25	PTS30-2	3,31	PTS30-5	2,87	PTS30-50	2,59	PTS30-100	2,44
TS40	25	PTS40-2	3,31	PTS40-5	2,87	PTS40-50	2,59	PTS40-100	2,44

HEXAGONAL

€ per Bit
2 U
5 U
50 U
100 U

	L1 mm		€		€		€		€
2 mm	25	PHX2-2	1,83	PHX2-5	1,66	PHX2-50	1,48	PHX2-100	1,42
2,5 mm	25	PHX2,5-2	1,83	PHX2,5-5	1,66	PHX2,5-50	1,48	PHX2,5-100	1,42
3 mm	25	PHX3-2	1,83	PHX3-5	1,66	PHX3-50	1,48	PHX3-100	1,42
4 mm	25	PHX4-2	1,83	PHX4-5	1,66	PHX4-50	1,48	PHX4-100	1,42
5 mm	25	PHX5-2	1,83	PHX5-5	1,66	PHX5-50	1,48	PHX5-100	1,42
6 mm	25	PHX6-2	1,83	PHX6-5	1,66	PHX6-50	1,48	PHX6-100	1,42
8 mm	25	PHX8-2	2,17	PHX8-5	1,97	PHX8-50	1,90	PHX8-100	1,79

**TRI
WING**

€ per Bit
2 U
5 U
50 U
100 U

	L1 mm		€		€		€		€
N°4	25	PTRW4-2	10,92	PTRW4-5	9,50	PTRW4-50	8,55	PTRW4-100	8,08
N°5	25	PTRW5-2	10,92	PTRW5-5	9,50	PTRW5-50	8,55	PTRW5-100	8,08
N°6	25	PTRW6-2	10,92	PTRW6-5	9,50	PTRW6-50	8,55	PTRW6-100	8,08
N°8	25	PTRW8-2	10,92	PTRW8-5	9,50	PTRW8-50	8,55	PTRW8-100	8,08

XZN

€ per Bit
2 U
5 U
50 U
100 U

	L1 mm		€		€		€		€
N°4	25	PXZN4-2	6,69	PXZN4-5	5,83	PXZN4-50	5,24	PXZN4-100	4,95
N°5	25	PXZN5-2	6,69	PXZN5-5	5,83	PXZN5-50	5,24	PXZN5-100	4,95
N°6	25	PXZN6-2	6,69	PXZN6-5	5,83	PXZN6-50	5,24	PXZN6-100	4,95
N°8	25	PXZN8-2	7,51	PXZN8-5	6,53	PXZN8-50	6,41	PXZN8-100	6,29
N°10	25	PXZN10-2	7,51	PXZN10-5	6,53	PXZN10-50	6,41	PXZN10-100	6,29

INTERCHANGEABLE SCREWDRIVER BITS



50mm
OVERALL
LENGTH
(L)



Screwdriver bits

Pink

PHILLIPS



€ per Bit		2 U		5 U		50 U	
	L1 mm		€		€		€
Ph 1	50	Ph1X50-2	2,97	Ph1X50-5	2,59	Ph1X50-50	2,33
Ph 2	50	Ph2X50-2	2,97	Ph2X50-5	2,59	Ph2X50-50	2,33
Ph 3	50	Ph3X50-2	2,97	Ph3X50-5	2,59	Ph3X50-50	2,33
Ph 4	50	Ph4X50-2	-	Ph4X50-5	-	Ph4X50-50	-

POZIDRIV



€ per Bit		2 U		5 U		50 U	
	L1 mm		€		€		€
Pz 1	50	Pz1X50-2	2,97	Pz1X50-5	2,59	Pz1X50-50	2,33
Pz 2	50	Pz2X50-2	2,97	Pz2X50-5	2,59	Pz2X50-50	2,33
Pz 3	50	Pz3X50-2	2,97	Pz3X50-5	2,59	Pz3X50-50	2,33
Pz 4	50	Pz4X50-2	-	Pz4X50-5	-	Pz4X50-50	-

SLOT



€ per Bit		2 U		5 U		50 U	
	L1 mm		€		€		€
0,5X4,0	50	P0,5X4,0X50-2	4,69	P0,5X4,0X50-5	4,06	P0,5X4,0X50-50	3,64
0,5X3,0	50	P0,5X3,0X50-2	4,69	P0,5X3,0X50-5	4,06	P0,5X3,0X50-50	3,64
0,6X3,5	50	P0,6X3,5X50-2	4,69	P0,6X3,5X50-5	4,06	P0,6X3,5X50-50	3,64
0,6X4,5	50	P0,6X4,5X50-2	4,69	P0,6X4,5X50-5	4,06	P0,6X4,5X50-50	3,64
0,8X4,0	50	P0,8X4,0X50-2	4,69	P0,8X4,0X50-5	4,06	P0,8X4,0X50-50	3,64
0,8X5,0	50	P0,8X5,0X50-2	4,69*	P0,8X5,0X50-5	4,06*	P0,8X5,0X50-50	3,64*
0,8X5,5	50	P0,8X5,5X50-2	4,69	P0,8X5,5X50-5	4,06	P0,8X5,5X50-50	3,64
1,0X5,5	50	P1X5,5X50-2	4,69	P1X5,5X50-5	4,06	P1X5,5X50-50	3,64
1,0X6,0	50	P1X6,0X50-2	4,69	P1X6,0X50-5	4,06	P1X6,0X50-50	3,64
1,2X6,5	50	P1,2X6,5X50-2	4,69	P1,2X6,5X50-5	4,06	P1,2X6,5X50-50	3,64
1,2X8,0	50	P1,2X8,0X50-2	4,69	P1,2X8,0X50-5	4,06	P1,2X8,0X50-50	3,64

*Until end of stock

INTERCHANGEABLE SCREWDRIVER BITS



TORX



€ per Bit		2 U		5 U		50 U	
	L1 mm		€		€		€
T 5	50	PT5X50-2	6,00	PT5X50-5	4,57	PT5X50-50	4,23
T 6	50	PT6X50-2	6,00	PT6X50-5	4,57	PT6X50-50	4,23
T 7	50	PT7X50-2	6,00	PT7X50-5	4,57	PT7X50-50	4,23
T 8	50	PT8X50-2	6,00	PT8X50-5	4,57	PT8X50-50	4,23
T 9	50	PT9X50-2	6,00	PT9X50-5	4,57	PT9X50-50	4,23
T 10	50	PT10X50-2	5,52	PT10X50-5	4,30	PT10X50-50	3,87
T 15	50	PT15X50-2	5,52	PT15X50-5	4,30	PT15X50-50	3,87
T 20	50	PT20X50-2	5,52	PT20X50-5	4,30	PT20X50-50	3,87
T 25	50	PT25X50-2	5,52	PT25X50-5	4,30	PT25X50-50	3,87
T 27	50	PT27X50-2	5,52	PT27X50-5	4,30	PT27X50-50	3,87
T 30	50	PT30X50-2	5,52	PT30X50-5	4,30	PT30X50-50	3,87
T 40	50	PT40X50-2	5,52	PT40X50-5	4,30	PT40X50-50	3,87

ROBERTSON



€ per Bit		2 U		5 U		50 U	
	L1 mm		€		€		€
N°1	50	PC1X50-2	7,20	PC1X50-5	6,26	PC1X50-50	5,64
N°2	50	PC2X50-2	7,20	PC2X50-5	6,26	PC2X50-50	5,64
N°3	50	PC3X50-2	7,20	PC3X50-5	6,26	PC3X50-50	5,64

HEXAGONAL



€ per Bit		2 U		5 U		50 U	
	L1 mm		€		€		€
2 mm	50	PHX2X50-2	5,83	PHX2X50-5	5,07	PHX2X50-50	4,56
2,5 mm	50	PHX2,5X50-2	5,83	PHX2,5X50-5	5,07	PHX2,5X50-50	4,56
3 mm	50	PHX3X50-2	5,83	PHX3X50-5	5,07	PHX3X50-50	4,56
4 mm	50	PHX4X50-2	5,83	PHX4X50-5	5,07	PHX4X50-50	4,56
5 mm	50	PHX5X50-2	5,83	PHX5X50-5	5,07	PHX5X50-50	4,56
6 mm	50	PHX6X50-2	5,83	PHX6X50-5	5,07	PHX6X50-50	4,56
8 mm	50	PHX8X50-2	7,47	PHX8X50-5	6,84	PHX8X50-50	5,85

INTERCHANGEABLE SCREWDRIVER BITS

Screwdriver bits

Pink



70mm
OVERALL
LENGTH
(L.)



PHILLIPS



€ per Bit

2 U

5 U

	L1 mm		€		€
Ph 1	70	Ph1X70-2	6,97	Ph1X70-5	6,07
Ph 2	70	Ph2X70-2	6,97	Ph2X70-5	6,07
Ph 3	70	Ph3X70-2	6,97	Ph3X70-5	6,07
Ph 4	70	Ph4X70-2	-	Ph4X70-5	-

POZIDRIV



€ per Bit

2 U

5 U

	L1 mm		€		€
Pz 1	70	Pz1X70-2	7,04	Pz1X70-5	6,12
Pz 2	70	Pz2X70-2	7,04	Pz2X70-5	6,12
Pz 3	70	Pz3X70-2	7,04	Pz3X70-5	6,12
Pz 4	70	Pz4X70-2	-	Pz4X70-5	-



90mm
OVERALL
LENGTH
(L.)



PHILLIPS



€ per Bit

2 U

5 U

	L1 mm		€		€
Ph 1	90	Ph1X90-2	8,59	Ph1X90-5	7,48
Ph 2	90	Ph2X90-2	8,59	Ph2X90-5	7,48
Ph 3	90	Ph3X90-2	8,59	Ph3X90-5	7,48
Ph 4	90	Ph4X90-2	-	Ph4X90-5	-

POZIDRIV



€ per Bit

2 U

5 U

	L1 mm		€		€
Pz 1	90	Pz1X90-2	8,67	Pz1X90-5	7,55
Pz 2	90	Pz2X90-2	8,67	Pz2X90-5	7,55
Pz 3	90	Pz3X90-2	8,67	Pz3X90-5	7,55
Pz 4	90	Pz4X90-2	-	Pz4X90-5	-

INTERCHANGEABLE SCREWDRIVER BITS

Screwdriver bits

Pink

TiN

25mm
 OVERALL
 LENGTH
 (L)

PHILLIPS

€ per Bit
2 U
5 U
50 U

	L1 mm		€		€		€
Ph 1	25	Ph1T-2	3,51	Ph1T-5	2,65	Ph1T-50	2,38
Ph 2	25	Ph2T-2	3,51	Ph2T-5	2,65	Ph2T-50	2,38
Ph 3	25	Ph3T-2	3,51	Ph3T-5	2,65	Ph3T-50	2,38

POZIDRIV

€ per Bit
2 U
5 U
50 U

	L1 mm		€		€		€
Pz 1	25	Pz1T-2	3,54	Pz1T-5	2,67	Pz1T-50	2,41
Pz 2	25	Pz2T-2	3,54	Pz2T-5	2,67	Pz2T-50	2,41
Pz 3	25	Pz3T-2	3,54	Pz3T-5	2,67	Pz3T-50	2,41

SLOT

€ per Bit
2 U
5 U
50 U

	L1 mm		€		€		€
0,6X4,5	25	P0,6X4,5T-2	3,80	P0,6X4,5T-5	3,29	P0,6X4,5T-50	2,96
0,8X5,5	25	P0,8X5,5T-2	3,80	P0,8X5,5T-5	3,29	P0,8X5,5T-50	2,96
1,0X5,5	25	P1X5,5T-2	3,80	P1X5,5T-5	3,29	P1X5,5T-50	2,96
1,2X6,5	25	P1,2X6,5T-2	3,80	P1,2X6,5T-5	3,29	P1,2X6,5T-50	2,96

TORX

€ per Bit
2 U
5 U
50 U

	L1 mm		€		€		€
T 10	25	PT10T-2	3,65	PT10T-5	3,28	PT10T-50	2,87
T 15	25	PT15T-2	3,65	PT15T-5	3,28	PT15T-50	2,87
T 20	25	PT20T-2	3,65	PT20T-5	3,28	PT20T-50	2,87
T 25	25	PT25T-2	3,65	PT25T-5	3,28	PT25T-50	2,87
T 27	25	PT27T-2	3,65	PT27T-5	3,28	PT27T-50	2,87
T 30	25	PT30T-2	3,65	PT30T-5	3,28	PT30T-50	2,87
T 40	25	PT40T-2	3,65	PT40T-5	3,28	PT40T-50	2,87

INTERCHANGEABLE SCREWDRIVER BITS

TiN



50mm
OVERALL
LENGTH
(L)



PHILLIPS



€ per Bit		2 U		5 U		50 U	
	L1 mm		€		€		€
Ph 1	50	Ph1Tx50-2	8,09	Ph1Tx50-5	7,03	Ph1Tx50-50	6,31
Ph 2	50	Ph2Tx50-2	8,09	Ph2Tx50-5	7,03	Ph2Tx50-50	6,31
Ph 3	50	Ph3Tx50-2	8,09	Ph3Tx50-5	7,03	Ph3Tx50-50	6,31

POZIDRIV



€ per Bit		2 U		5 U		50 U	
	L1 mm		€		€		€
Pz 1	50	Pz1Tx50-2	8,17	Pz1Tx50-5	7,10	Pz1Tx50-50	6,37
Pz 2	50	Pz2Tx50-2	8,17	Pz2Tx50-5	7,10	Pz2Tx50-50	6,37
Pz 3	50	Pz3Tx50-2	8,17	Pz3Tx50-5	7,10	Pz3Tx50-50	6,37

TORX



€ per Bit		2 U		5 U		50 U	
	L1 mm		€		€		€
T 10	50	PT10Tx50-2	11,57	PT10Tx50-5	10,06	PT10Tx50-50	9,05
T 15	50	PT15Tx50-2	11,57	PT15Tx50-5	10,06	PT15Tx50-50	9,05
T 20	50	PT20Tx50-2	11,57	PT20Tx50-5	10,06	PT20Tx50-50	9,05
T 25	50	PT25Tx50-2	11,57	PT25Tx50-5	10,06	PT25Tx50-50	9,05
T 27	50	PT27Tx50-2	11,57	PT27Tx50-5	10,06	PT27Tx50-50	9,05
T 30	50	PT30Tx50-2	11,57	PT30Tx50-5	10,06	PT30Tx50-50	9,05
T 40	50	PT40Tx50-2	11,57	PT40Tx50-5	10,06	PT40Tx50-50	9,05

SCREWDRIVER BIT HOLDERS
MAGNETIC SCREWDRIVER BIT HOLDERS

	L1 mm	SHANK TYPE	€
PMGx51	51	MAGNETIC WITHOUT RING	6,99
PMGx58	58	MAGNETIC WITHOUT RING	7,26
PMGx74	74	MAGNETIC WITH RING	11,97
PMGx100	100	MAGNETIC WITH RING	14,48
PMGx150	150	MAGNETIC WITH RING	16,13
PMGx200	200	MAGNETIC WITH RING	19,09
PMGx250	250	MAGNETIC WITH RING	29,36
PMGSDSx78	78	SDS PLUS	20,03
PBERx74	74	BERYLLIUM	51,40*
PDESSx70	70	5/16" DESSOUTTER	31,67*
P7x74	74	7mm Fein	34,40*

*Until end of stock

MAGNETIC HOLDER WITH QUICK CHANGE (VALID FOR 1/4" SCREWDRIVER BITS WITH CIRCLIP)

	L1 mm	SHANK TYPE	€
PCR60	60	Quick change 1/4" Valid for 1/4" screwdriver bits with circlip	17,81
PCR74	74	Quick change 1/4" Valid for 1/4" screwdriver bits with circlip	18,34
PCRSDSX80	80	SDS PLUS	29,21

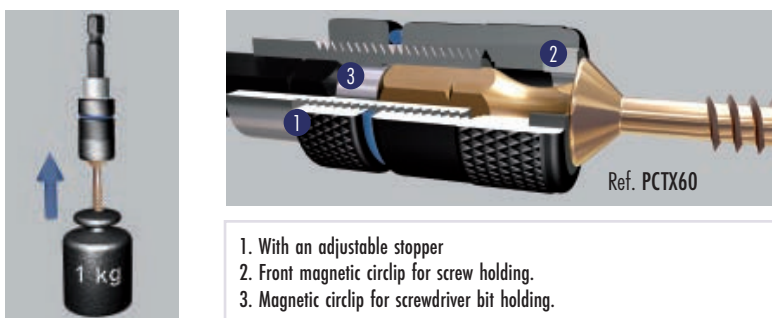
SCREWDRIVER BITS HOLDERS WITH ADJUSTABLE STOPPER

1. With an adjustable stopper
2. Front magnetic circlip for screw holding.
3. Magnetic circlip for screwdriver bit holding.

	L1 mm	SHANK TYPE	€
PCTX60	60	Adjustable stopper	16,77



STANDARD HEXAGONAL NUT DRIVERS



MAGNETIC HEXAGONAL NUT DRIVERS



	mm	"		€/ 1U.
PLHX5-2	5,0		2	6,35
PLHX5,5-2	5,5		2	6,35
PLHX6-2	6,0		2	6,35
PLHX1/4-2		1/4"=6,35	2	6,35
PLHX7-2	7,0		2	6,49
PLHX5/16-2		5/16"=7,93	2	6,49
PLHX8-2	8,0		2	6,49
PLHX3/8-2		3/8"=9,52	2	6,49
PLHX10-2	10,0		2	6,65
PLHX11-2	11,0		2	6,84
PLHX12-2	12,0		2	6,90
PLHX13-2	13,0		2	7,23

7 MAGNETIC HEXAGONAL NUT DRIVERS BOX

REFERENCE	EPLL
QUANTITY	7
CONTENT	HX1/4 - HX7 - HX8 - HX3/8 HX10 - HX12 - HX13
PRICE €	47,09



RATCHET SCREWDRIVER WITH BITS STORAGE

Plus

1. High quality and performance
2. Left and right hand turn
3. Telescopic and adjustable
4. Manufactured in high quality plastic and steel

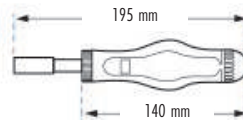

DTRC

- Screwdriver bits included:
- PH1 - PH2
 - PZ1 - PZ2
 - T15 - T20 - T25 - T30

35,77 €

SCREWDRIVER BITS SETS

DiN 7 SCREWDRIVER BIT SETS



Ref. EPT1

REFERENCE	EPT1	EPT2	EPT3
QUANTITY	7	7	7
CONTENT	<ul style="list-style-type: none"> PH1 - PH2 PZ1 - PZ2 0,8x5,5 - 1,2x6,5 1 PMG Bit holder	<ul style="list-style-type: none"> T10 - T15 T20 - T25 T30 - T40 1 PMG Bit holder	<ul style="list-style-type: none"> PH1 - PH2 - PH3 PZ1 - PZ2 - PZ3 1 PMG Bit holder
PRICE €	12,45	16,78	14,92



Ref. EPTT1

REFERENCE	EPTT1	EPTT2	EPTT3
QUANTITY	7	7	7
CONTENT	<ul style="list-style-type: none"> PH1 - PH2 PZ1 - PZ2 0,8x5,5 - 1,2x6,5 1 PMG Bit holder	<ul style="list-style-type: none"> T10 - T15 T20 - T25 T30 - T40 1 PMG Bit holder	<ul style="list-style-type: none"> PH1 - PH2 - PH3 PZ1 - PZ2 - PZ3 1 PMG Bit holder
PRICE €	35,31	40,95	34,04

SCREWDRIVER BITS SETS
PLUS & TiN 12 SCREWDRIVER BIT SETS

Ref. EPT4

 REFERENCE
 QUANTITY
 CONTENT

EPT4	
QUANTITY	12
CONTENT	+ PH1 - PH2(2) - PH3 + PZ1 - PZ2(2) - PZ3 - 0,6x4,5 - 0,8x5,5 - 1,2x6,5 1 PMG Bit holder

EPT5	
QUANTITY	12
CONTENT	T10 - T15(2) * T20(2) - T25(2) T27 - T30(2) - T40 1 PMG Bit holder

PRICE €

16,70

22,93

Ref. EPTT4

 REFERENCE
 QUANTITY
 CONTENT

EPTT4	
QUANTITY	12
CONTENT	+ PH1 - PH2(2) - PH3 + PZ1 - PZ2(2) - PZ3 - 0,6x4,5 - 0,8x5,5 - 1,2x6,5 1 PCT Bit holder

EPTT5	
QUANTITY	12
CONTENT	T10 - T15(2) * T20(2) - T25(2) T27 - T30(2) - T40 1 PCT Bit holder

PRICE €

44,47

52,31

PLUS & TiN 31 SCREWDRIVER BIT SETS

Ref. EPT6

 REFERENCE
 QUANTITY
 CONTENT

EPT6	
QUANTITY	31
CONTENT	+ PH1(3) - PH2(3) - PH3(3) + PZ1(3) - PZ2(3) - PZ3(3) - 0,6x4,5 - 0,8x5,5 - 1,2x6,5

EPT6	
QUANTITY	31
CONTENT	* T10 - T15 - T20 - T25 - T30 - T40 H3 - H4 - H5 1 PMG Bit holder

PRICE €

47,72

 REFERENCE
 QUANTITY
 CONTENT

EPTT6	
QUANTITY	31
CONTENT	+ PH1(3) - PH2(3) - PH3(3) + PZ1(3) - PZ2(3) - PZ3(3) - 0,6x4,5 - 0,8x5,5 - 1,2x6,5

EPTT6	
QUANTITY	31
CONTENT	* T10 - T15 - T20 - T25 - T30 - T40 H3 - H4 - H5 1 PCT Bit holder

PRICE €

101,25

PLUS & TiN 36 SCREWDRIVER BIT SETS

Ref. EPT7

 REFERENCE
 QUANTITY
 CONTENT

EPT7	
QUANTITY	36
CONTENT	+ PH1(3) - PH2(3) - PH3(3) + PZ1(3) - PZ2(3) - PZ3(3) - 0,5 x 4 - 0,6 x 4,5 - 0,8 x 5 - 0,8 x 5,5 - 1 x 6 - 1,2 x 6,5 - 1,2 x 8 1 PMG Bit holder

EPT7	
QUANTITY	36
CONTENT	* T10 - T15 - T20 - T25 - T27 - T30 - T40 H2 - H2,5 - H3 - H4 - H5 - H6 - H8

PRICE €

60,43

 REFERENCE
 QUANTITY
 CONTENT

EPTT7*	
QUANTITY	36
CONTENT	+ PH1(3) - PH2(3) - PH3(3) + PZ1(3) - PZ2(3) - PZ3(3) - 0,5 x 4 - 0,6 x 4,5 - 0,8 x 5 - 0,8 x 5,5 - 1 x 6 - 1,2 x 6,5 - 1,2 x 8 1 PCT Bit holder

EPTT7*	
QUANTITY	36
CONTENT	* T10 - T15 - T20 - T25 - T27 - T30 - T40 H2 - H2,5 - H3 - H4 - H5 - H6 - H8

PRICE €

123,99*

Ref. EPTT7

*Until end of stock

SCREWDRIVER BITS SETS

45 & 80 SCREWDRIVER BITS SETS

Screwdriver bits

Pink



Ref. EPT45



Ref. EPT80

REFERENCE	EPT45	
QUANTITY	45	
CONTENT	<ul style="list-style-type: none"> PH1(2) - PH2(2) - PH3(2) PZ1(2) - PZ2(2) - PZ3(2) 0,5x3-0,6x4,5-0,8x5,5(2)-1,2x6,5-1,6x8 H2,5 - H3 - H4 - H5 - H6 - H7 T10 - T15 - T20 - T25 - T30 - T40 	<ul style="list-style-type: none"> Hexagonal sockets (mm): 5 - 6 - 7 - 8 - 9 - 10 - 11 - 12 - 13 - 14 1 Sockets adapter 1 Screwdriver bits adapter 1 PCR Magnetic bit holder 1 Ratched handle 72 teeth 1 Screwdriver
PRICE €	151,21	



REFERENCE	EPT80*	
QUANTITY	80	
CONTENT	<ul style="list-style-type: none"> PH0 - PH1 - PH2(4) - PH3(2) PZ1 - PZ2(4) - PZ3(2) 0,5x3-0,6x4,5-0,8x5,5(2)-1,2x6,5-1,6x8 H2 - H2,5 - H3 - H4 - H5 - H6 - H7 - H8 TW1 - TW2 - TW3 - TW4 - TW5 TQ5 - TQ6 - TQ8 - TQ10 T5 - T6 - T7 - T8 - T9 - T10 - T15 T20(2) - T25(2) - T27 - T30 - T40 TS10 - TS15 - TS20 - TS25 - TS30 - TS40 	<ul style="list-style-type: none"> C0 - C1 - C2 - C3 SP4 - SP6 - SP8 - SP10 HS3 - HS4 - HS5 - HS6 1 PCR Magnetic bit holder 1 Screwdriver PH1 - PH2 PZ1 - PZ2 T15 - T20 - T25 - T30
PRICE €	155,24*	

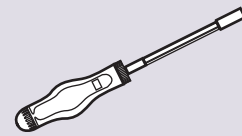

*Until end of stock

MACHINE SCREW EXTRACTORS

MICRO GRABIT

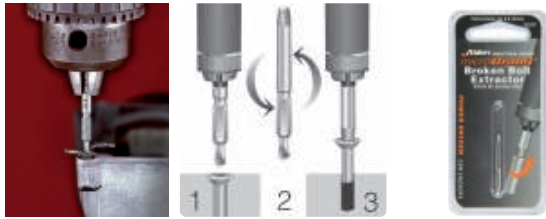

		EP
		€
EP451C	M3	55,10
EP452C	M4	55,10
EP453C	M5	55,10
EP454C	M6	55,10

1. Drill the screw
2. Flip the extractor
3. Remove

PRO GRABIT WITH 1/4" HEXAGONAL BODY

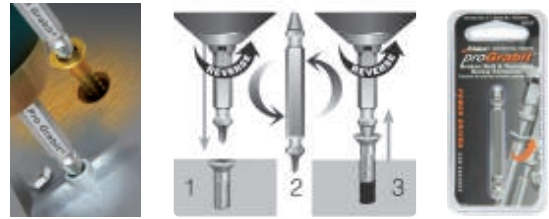

		EP
		€
EP8401C	M5	43,70
EP8402C	M6	51,63
EP8403C	M8	51,63
EP8404C	M10	54,18

1. Drill the screw
2. Flip the extractor
3. Remove

DRILL-OUT WITH PILOT DRILL (M6-M12)

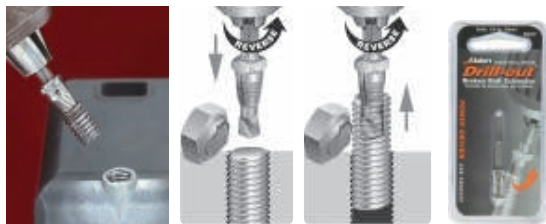

		EP
		€
EP205C	M6	53,42
EP312C	M8	64,73
EP375C	M10	64,73
EP500C	M12	72,86

X-OUT WITH HEXAGONAL SHANK



		EP
		€
EP3701C	M3	43,70
EP3702C	M4	43,70
EP3703C	M5	48,57

MACHINE SCREW EXTRACTORS SETS

MICRO GRABIT



REFERENCE	EP450C
QUANTITY	4
CONTENT	M3-M4-M5-M6
PRICE €	226,00

MICRO GRABIT



REFERENCE	EP401C
QUANTITY	4
CONTENT	M6-M8-M10-M12
PRICE €	265,87

HAND SCREW EXTRACTORS SETS

HAND SCREW EXTRACTOR CLASSIC SETS

Use a BLUE-MASTER drill to make a hole where to introduce the screw extractor.
Turn the extractor anti-clockwise until the broken screw comes out.

REFERENCE	EX/1-5	EX/1-6	EX/1-8
QUANTITY	5	6	8
CONTENT	M3 - M18	M3 - M24	M3 - M45
PRICE €	23,38	31,64	73,03



Ref. EX/1-6



	for SCREWS	mm	mm	L1 mm	Ø min mm	Ø max. mm	EX €
EX/1	M3 - M6	3,2	2,5	51	1,75	3,95	2,90
EX/2	M6 - M8	4,0	3,0	60	2,20	4,80	2,90
EX/3	M8 - M11	5,1	4,5	68	3,30	6,40	3,44
EX/4	M11 - M14	6,2	6,0	76	4,75	8,40	4,26
EX/5	M14 - M18	8,6	8,0	86	6,35	11,00	5,54
EX/6	M18 - M24	12,0	11,0	95	9,50	15,00	9,38
EX/7	M24 - M33	15,9	14,0	105	12,70	19,00	25,40
EX/8	M33 - M45	20,0	21,0	111	19,00	25,00	41,61



REFERENCE	EXTT
QUANTITY	10
CONTENT	EX/1-EX/2-EX/3-EX/4-EX/5 Ref. BC3 Ø2,5-3-4,5-6-8
PRICE €	39,01

HAND SCREW EXTRACTORS SETS



	for SCREWS	mm	mm	L1 mm	Ø min mm	Ø max. mm	EFX €
EFX/1	M3-M6	2,9	2,0	50	1,9	3,2	3,69
EFX/2	M6-M8	3,9	3,2	60	2,8	5,0	3,69
EFX/3	M8-M11	4,8	4,0	68	3,2	6,5	4,35
EFX/4	M11-M14	6,7	6,4	75	5,2	9,0	5,40
EFX/5	M14-M18	8,5	7,1	85	6,4	11,0	7,00
EFX/6	M18-M25	11,8	9,5	95	9,4	15,0	11,88
EFX/7	M25-M35	14,3	12,7	106	12,8	19,0	32,16
EFX/8	M35-M45	19,5	19,5	110	19,3	25,0	52,67



Ref. EFX/1-5

REFERENCE	EFX/1-5
QUANTITY	5
CONTENT	M3 - M18
PRICE €	28,16

DIN 338 TWIST DRILL

Ref. BH2

HSS



OX



	Ø mm	L1 x L2 mm	mm	BH2 €
BH20200	2,00	61 x 33	1/4"	7,52
BH20300	3,00	61 x 33	1/4"	7,69
BH20400	4,00	75 x 43	1/4"	8,14
BH20500	5,00	86 x 52	1/4"	10,12
BH20600	6,00	93 x 57	1/4"	10,93
BH20700	7,00	109 x 69	1/4"	13,78
BH20800	8,00	117 x 75	1/4"	15,47
BH20900	9,00	125 x 81	1/4"	17,40
BH21000	10,00	133 x 87	1/4"	19,38



REFERENCE	BH29335	BH29333
QUANTITY	5	8
QUALITY	HSS	HSS
CONTENT	Ø 3-4-5-6-8 mm	Ø 3-4-5-6-7-8-9-10 mm
PRICE €	53,15	71,10

1/4" HEXAGONAL SHANK TOOLS

EXTRA SHORT METAL DRILL

HSS-G

Ref. BC59

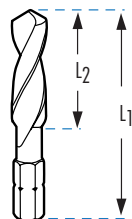

DRILL TAP COUNTERSINK

HSS-G

Ref. MAHM

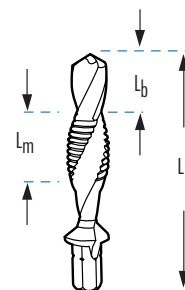

	Ø mm	L1 x L2 mm		BC59 €	BC59CR €
BC590100	1,00	34 x 12	1/4"	7,52	-
BC590150	1,50	34 x 12	1/4"	7,52	-
BC590200	2,00	34 x 12	1/4"	7,52	7,52
BC590250	2,50	36 x 14	1/4"	7,52	7,52
BC590300	3,00	38 x 16	1/4"	7,52	7,52
BC590330	3,30	40 x 18	1/4"	7,52	7,52
BC590350	3,50	40 x 18	1/4"	7,52	7,52
BC590400	4,00	44 x 20	1/4"	7,52	7,52
BC590420	4,20	45 x 20	1/4"	7,52	7,52
BC590450	4,50	46 x 24	1/4"	7,52	7,52
BC590500	5,00	50 x 26	1/4"	7,52	7,52
BC590550	5,50	50 x 26	1/4"	8,21	8,21
BC590600	6,00	50 x 26	1/4"	8,21	8,21
BC590650	6,50	50 x 30	1/4"	8,21	8,21
BC590680	6,80	50 x 30	1/4"	8,21	8,21
BC590700	7,00	50 x 30	1/4"	8,21	8,21
BC590750	7,50	51 x 32	1/4"	9,29	9,29
BC590800	8,00	51 x 32	1/4"	9,29	9,29
BC590850	8,50	53 x 33	1/4"	9,29	9,29
BC590900	9,00	53 x 33	1/4"	11,21	11,21
BC590950	9,50	54 x 38	1/4"	11,21	11,21
BC591000	10,00	54 x 38	1/4"	11,21	11,21
BC591020	10,20	54 x 38	1/4"	11,21	11,21

	L1 x Lb x Lm mm		MAHM €	MAHMCR €
M 3 x 0,50	36 x 5 x 6	1/4"	24,53	24,53
M 4 x 0,70	39 x 6 x 7	1/4"	24,53	24,53
M 5 x 0,80	41 x 8 x 8	1/4"	25,60	25,60
M 6 x 1,00	44 x 8 x 10	1/4"	26,66	26,66
M 8 x 1,25	50 x 10 x 11	1/4"	36,86	36,86
M 10 x 1,50	59 x 11 x 11	1/4"	44,47	44,47



REFERENCE	MAH9327CR
QUANTITY	5
DRILL REFERENCE	MAHMCR
CONTENT	M4-M5-M6-M8-M10
PRICE €	182,64

HSS-G TAP

HSS-G

Ref. M

	L1 x L2 mm		M €	MCR €
M 3 x 0,50	33 x 11	1/4"	8,90	8,90
M 4 x 0,70	35 x 12	1/4"	8,90	8,90
M 5 x 0,80	36 x 15	1/4"	11,34	11,34
M 6 x 1,00	39 x 18	1/4"	11,34	11,34
M 8 x 1,25	40 x 19	1/4"	15,70	15,70
M 10 x 1,50	41 x 21	1/4"	19,39	19,39

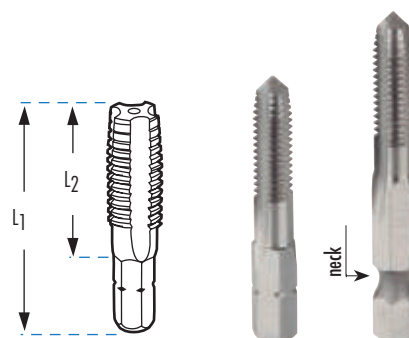

1/4" HEXAGONAL SHANK TOOLS

HSSCo STEP CUT DRILL-TAP WITH COUNTERSINK

NEW

DIN 13

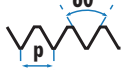

HSSCo
5%

BRIGHT

TOL
6H

D
REDUCED
SHANK

1/4"

Ref. MTKM

STEP CUT

										MTKM
		Lb mm	Lm mm	L3 mm	L mm	Db mm	D2 mm	D3 mm		€
M	3x0,50	D 7,0	6,0	6,0	57,0	2,5	2,2	7,3	1/4"	28,21
M	4x0,70	D 7,0	8,5	6,0	62,0	3,3	3,0	7,3	1/4"	28,21
M	5x0,80	D 9,0	10,0	6,0	69,0	4,2	3,7	7,3	1/4"	29,44
M	6x1,00	D 10,0	12,0	6,0	73,0	5,0	4,5	7,3	1/4"	30,66
M	8x1,25	D 12,0	16,0	6,0	87,0	6,8	6,3	9,4	1/4"	42,38
M	10x1,50	D 14,0	20,0	6,0	96,0	8,5	8,0	11,4	1/4"	51,14
M	12x1,75	D 16,0	24,0	8,0	112,0	10,3	9,8	13,4	1/4"	56,36

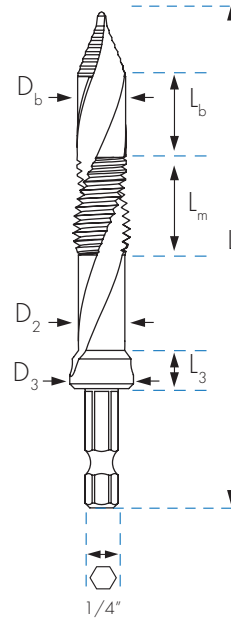

3 CUTS COUNTERSINKS

HSS-G

Ref. AV22

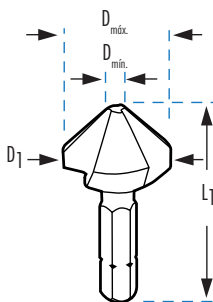

DEBURRING COUNTERSINK

HSS



1/4"

Ref. AV1...CR

Ref. AV101CR
Ref. AV102CR



Ref. AV103CR
Ref. AV104CR

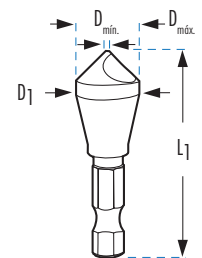

					AV22
D1 mm	L1 mm	D min. - D max. mm		€	
6,30	31	1,50 - 5,8	1/4"	22,65	
8,30	31	2,00 - 7,8	1/4"	22,65	
10,40	34	2,50 - 10,0	1/4"	24,27	
12,40	35	2,80 - 12,0	1/4"	25,89	
16,50	40	3,20 - 16,0	1/4"	27,73	
20,50	41	3,50 - 20,0	1/4"	33,27	

					AV1...CR
	D1 mm	L1 mm	D min. - D max. mm		€
AV101CR	10,00	40	2,0 - 5,0	1/4"	22,66
AV102CR	14,00	42	5,0 - 10,0	1/4"	28,33
AV103CR	17,00	45	5,0 - 13,0	1/4"	50,73
AV104CR	25,00	55	7,0 - 20,0	1/4"	90,60

1/4" HEXAGONAL SHANK TOOLS

PROFESSIONAL MASONRY DRILL

Ref. BWH

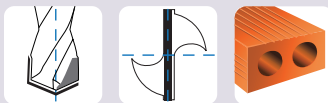

	Ø mm	L1 x L2 mm		BWH €
BWH03	3	70 x 30	1/4"	3,23
BWH04	4	70 x 30	1/4"	3,50
BWH05	5	85 x 45	1/4"	3,79
BWH06	6	100 x 50	1/4"	4,21
BWH07	7	100 x 50	1/4"	4,95
BWH08	8	120 x 70	1/4"	5,72
BWH09	9	120 x 70	1/4"	6,85
BWH10	10	120 x 70	1/4"	7,67
BWH11	11	150 x 80	1/4"	9,54
BWH12	12	150 x 80	1/4"	10,78
BWH13	13	150 x 80	1/4"	13,27
BWH14	14	150 x 80	1/4"	15,46

WOOD WORKING DRILL

Ref. BMH

CV



	Ø mm	L1 x L2 mm		BMH €
BMH03	3	59 x 35	1/4"	2,07
BMH04	4	74 x 41	1/4"	2,17
BMH05	5	82 x 55	1/4"	2,15
BMH06	6	88 x 58	1/4"	2,90
BMH07	7	110 x 70	1/4"	3,29
BMH08	8	110 x 70	1/4"	3,42
BMH09	9	110 x 70	1/4"	3,56
BMH10	10	115 x 75	1/4"	3,94
BMH11	11	135 x 85	1/4"	4,60
BMH12	12	135 x 85	1/4"	5,40
BMH13	13	135 x 90	1/4"	8,45
BMH14	14	145 x 95	1/4"	10,51



REFERENCE	BWH9318	BWH9327	BWH9319	BMH9335	BMH9333
QUANTITY	5	5	8	5	8
APPLICATION	CONCRETE	CONCRETE	CONCRETE	WOOD	WOOD
CONTENT	Ø 3 - 4 - 5 - 6 - 8 mm	Ø 4 - 5 - 6 - 8 - 10 mm	Ø 3 - 4 - 5 - 6 - 7 - 8 - 9 - 10 mm	Ø 3 - 4 - 5 - 6 - 8 mm	Ø 3 - 4 - 5 - 6 - 7 - 8 - 9 - 10 mm
PRICE €	27,28	32,92	37,70	16,93	22,33

1/4" HEXAGONAL SHANK DRILL BOXES



Ref. EB



Ref. EMBP

CONTENT

	 HSS-G	 HSS-G			€
EM	M3 - M4 - M5 - M6 M8 - M10	-	-	-	72,19
EMBP	M3 - M4 - M5 - M6 M8 - M10	Ø 2,50 - 3,30 - 4,20 5 - 6,80 - 8,50	-	-	104,08
EBM	-	-	M3 - M4 - M5 - M6 M8 - M10	-	158,91
EA	-	-	-	Ø 6,30 - 8,30 - 10,40 12,40 - 16,50 - 20,50	145,70
EB	-	Ø 1 - 10 mm x 0,50	-	-	121,39