



BLUE-MASTER[®]
by *celessa*



INSERTI PER
AVVITATORE

INSERTI INTERCAMBIABILI PER AVVITATORE



PHILLIPS



€ x Insetto 2 U. 5 U. 50 U. 100 U.

| | L1 mm | | € | | € | | € | | € |
|------|----------|-------|-------------|-------|-------------|--------|-------------|---------|-------------|
| Ph 0 | 25 | Ph0-2 | 1,63 | Ph0-5 | 1,44 | Ph0-50 | 1,28 | Ph0-100 | 1,22 |
| Ph 1 | 25 | Ph1-2 | 1,38 | Ph1-5 | 0,85 | Ph1-50 | 0,77 | Ph1-100 | 0,72 |
| Ph 2 | 25 | Ph2-2 | 1,38 | Ph2-5 | 0,85 | Ph2-50 | 0,77 | Ph2-100 | 0,72 |
| Ph 3 | 25 | Ph3-2 | 1,38 | Ph3-5 | 0,85 | Ph3-50 | 0,77 | Ph3-100 | 0,72 |

POZIDRIV



€ x Insetto 2 U. 5 U. 50 U. 100 U.

| | L1 mm | | € | | € | | € | | € |
|------|----------|-------|-------------|-------|-------------|--------|-------------|---------|-------------|
| Pz 0 | 25 | Pz0-2 | 1,63 | Pz0-5 | 1,44 | Pz0-50 | 1,28 | Pz0-100 | 1,22 |
| Pz 1 | 25 | Pz1-2 | 1,38 | Pz1-5 | 0,85 | Pz1-50 | 0,77 | Pz1-100 | 0,72 |
| Pz 2 | 25 | Pz2-2 | 1,38 | Pz2-5 | 0,85 | Pz2-50 | 0,77 | Pz2-100 | 0,72 |
| Pz 3 | 25 | Pz3-2 | 1,38 | Pz3-5 | 0,85 | Pz3-50 | 0,77 | Pz3-100 | 0,72 |

TESTA
PIATTA

€ x Insetto 2 U. 5 U. 50 U. 100 U.

| | L1 mm | | € | | € | | € | | € |
|---------|----------|------------|-------------|------------|-------------|-------------|-------------|--------------|-------------|
| 0,5X3,0 | 25 | P0,5X3,0-2 | 1,85 | P0,5X3,0-5 | 1,60 | P0,5X3,0-50 | 1,45 | P0,5X3,0-100 | 1,37 |
| 0,6X3,5 | 25 | P0,6X3,5-2 | 1,85 | P0,6X3,5-5 | 1,60 | P0,6X3,5-50 | 1,45 | P0,6X3,5-100 | 1,37 |
| 0,5X4,0 | 25 | P0,5X4,0-2 | 1,85 | P0,5X4,0-5 | 1,60 | P0,5X4,0-50 | 1,45 | P0,5X4,0-100 | 1,37 |
| 0,6X4,5 | 25 | P0,6X4,5-2 | 1,85 | P0,6X4,5-5 | 1,60 | P0,6X4,5-50 | 1,45 | P0,6X4,5-100 | 1,37 |
| 0,8X4,0 | 25 | P0,8X4,0-2 | 1,85 | P0,8X4,0-5 | 1,60 | P0,8X4,0-50 | 1,45 | P0,8X4,0-100 | 1,37 |
| 0,8X5,0 | 25 | P0,8X5,0-2 | 1,85 | P0,8X5,0-5 | 1,60 | P0,8X5,0-50 | 1,45 | P0,8X5,0-100 | 1,37 |
| 0,8X5,5 | 25 | P0,8X5,5-2 | 1,85 | P0,8X5,5-5 | 1,60 | P0,8X5,5-50 | 1,45 | P0,8X5,5-100 | 1,37 |
| 1,0X5,5 | 25 | P1X5,5-2 | 1,85 | P1X5,5-5 | 1,60 | P1X5,5-50 | 1,45 | P1X5,5-100 | 1,37 |
| 1,0X6,0 | 25 | P1X6,0-2 | 1,85 | P1X6,0-5 | 1,60 | P1X6,0-50 | 1,45 | P1X6,0-100 | 1,37 |
| 1,2X6,5 | 25 | P1,2X6,5-2 | 1,85 | P1,2X6,5-5 | 1,60 | P1,2X6,5-50 | 1,45 | P1,2X6,5-100 | 1,37 |
| 1,2X8,0 | 25 | P1,2X8,0-2 | 1,85 | P1,2X8,0-5 | 1,60 | P1,2X8,0-50 | 1,45 | P1,2X8,0-100 | 1,37 |

INSERTI INTERCAMBIABILI PER AVVITATORE



25mm
LUNG.
TOTALE
(L.)



Inserti per Avvitatore
Rosa



| € x Insetto | | 2 U. | | 5 U. | | 50 U. | | 100 U. | |
|-------------|-------|--------|------|--------|------|---------|------|----------|------|
| | L1 mm | | € | | € | | € | | € |
| T5 | 25 | PT5-2 | 2,43 | PT5-5 | 2,11 | PT5-50 | 1,90 | PT5-100 | 1,80 |
| T6 | 25 | PT6-2 | 2,43 | PT6-5 | 2,11 | PT6-50 | 1,90 | PT6-100 | 1,80 |
| T7 | 25 | PT7-2 | 2,43 | PT7-5 | 2,11 | PT7-50 | 1,90 | PT7-100 | 1,80 |
| T8 | 25 | PT8-2 | 2,43 | PT8-5 | 2,11 | PT8-50 | 1,90 | PT8-100 | 1,80 |
| T9 | 25 | PT9-2 | 2,43 | PT9-5 | 2,11 | PT9-50 | 1,90 | PT9-100 | 1,80 |
| T10 | 25 | PT10-2 | 2,00 | PT10-5 | 1,56 | PT10-50 | 1,39 | PT10-100 | 1,32 |
| T15 | 25 | PT15-2 | 2,00 | PT15-5 | 1,56 | PT15-50 | 1,39 | PT15-100 | 1,32 |
| T20 | 25 | PT20-2 | 2,00 | PT20-5 | 1,56 | PT20-50 | 1,39 | PT20-100 | 1,32 |
| T25 | 25 | PT25-2 | 2,00 | PT25-5 | 1,56 | PT25-50 | 1,39 | PT25-100 | 1,32 |
| T27 | 25 | PT27-2 | 2,00 | PT27-5 | 1,56 | PT27-50 | 1,39 | PT27-100 | 1,32 |
| T30 | 25 | PT30-2 | 2,00 | PT30-5 | 1,56 | PT30-50 | 1,39 | PT30-100 | 1,32 |
| T40 | 25 | PT40-2 | 2,00 | PT40-5 | 1,56 | PT40-50 | 1,39 | PT40-100 | 1,32 |



| € x Insetto | | 2 U. | | 5 U. | | 50 U. | | 100 U. | |
|-------------|-------|---------|------|---------|------|----------|------|-----------|------|
| | L1 mm | | € | | € | | € | | € |
| TR10 | 25 | PTR10-2 | 6,47 | PTR10-5 | 5,62 | PTR10-50 | 5,07 | PTR10-100 | 4,77 |
| TR15 | 25 | PTR15-2 | 6,47 | PTR15-5 | 5,62 | PTR15-50 | 5,07 | PTR15-100 | 4,77 |
| TR20 | 25 | PTR20-2 | 6,47 | PTR20-5 | 5,62 | PTR20-50 | 5,07 | PTR20-100 | 4,77 |
| TR25 | 25 | PTR25-2 | 6,47 | PTR25-5 | 5,62 | PTR25-50 | 5,07 | PTR25-100 | 4,77 |
| TR30 | 25 | PTR30-2 | 6,47 | PTR30-5 | 5,62 | PTR30-50 | 5,07 | PTR30-100 | 4,77 |
| TR40 | 25 | PTR40-2 | 6,47 | PTR40-5 | 5,62 | PTR40-50 | 5,07 | PTR40-100 | 4,77 |



| € x Insetto | | 2 U. | | 5 U. | | 50 U. | | 100 U. | |
|-------------|-------|-------|------|-------|------|--------|------|---------|------|
| | L1 mm | | € | | € | | € | | € |
| N°1 | 25 | PC1-2 | 2,60 | PC1-5 | 2,27 | PC1-50 | 2,04 | PC1-100 | 1,93 |
| N°2 | 25 | PC2-2 | 2,60 | PC2-5 | 2,27 | PC2-50 | 2,04 | PC2-100 | 1,93 |
| N°3 | 25 | PC3-2 | 2,60 | PC3-5 | 2,27 | PC3-50 | 2,04 | PC3-100 | 1,93 |

INSERTI INTERCAMBIABILI PER AVVITATORE

TORX[®]
TAMPER RESISTANT

| € x Inserto | | 2 U. | | 5 U. | | 50 U. | | 100 U. | |
|-------------|-------|---------|------|---------|------|----------|------|-----------|------|
| | L1 mm | | € | | € | | € | | € |
| TS10 | 25 | PTS10-2 | 3,47 | PTS10-5 | 3,01 | PTS10-50 | 2,71 | PTS10-100 | 2,56 |
| TS15 | 25 | PTS15-2 | 3,47 | PTS15-5 | 3,01 | PTS15-50 | 2,71 | PTS15-100 | 2,56 |
| TS20 | 25 | PTS20-2 | 3,47 | PTS20-5 | 3,01 | PTS20-50 | 2,71 | PTS20-100 | 2,56 |
| TS25 | 25 | PTS25-2 | 3,47 | PTS25-5 | 3,01 | PTS25-50 | 2,71 | PTS25-100 | 2,56 |
| TS27 | 25 | PTS27-2 | 3,47 | PTS27-5 | 3,01 | PTS27-50 | 2,71 | PTS27-100 | 2,56 |
| TS30 | 25 | PTS30-2 | 3,47 | PTS30-5 | 3,01 | PTS30-50 | 2,71 | PTS30-100 | 2,56 |
| TS40 | 25 | PTS40-2 | 3,47 | PTS40-5 | 3,01 | PTS40-50 | 2,71 | PTS40-100 | 2,56 |

TESTA
ESAGONALE

| € x Inserto | | 2 U. | | 5 U. | | 50 U. | | 100 U. | |
|-------------|-------|----------|------|----------|------|-----------|------|------------|------|
| | L1 mm | | € | | € | | € | | € |
| 2 mm | 25 | PHX2-2 | 1,92 | PHX2-5 | 1,74 | PHX2-50 | 1,55 | PHX2-100 | 1,49 |
| 2,5 mm | 25 | PHX2,5-2 | 1,92 | PHX2,5-5 | 1,74 | PHX2,5-50 | 1,55 | PHX2,5-100 | 1,49 |
| 3 mm | 25 | PHX3-2 | 1,92 | PHX3-5 | 1,74 | PHX3-50 | 1,55 | PHX3-100 | 1,49 |
| 4 mm | 25 | PHX4-2 | 1,92 | PHX4-5 | 1,74 | PHX4-50 | 1,55 | PHX4-100 | 1,49 |
| 5 mm | 25 | PHX5-2 | 1,92 | PHX5-5 | 1,74 | PHX5-50 | 1,55 | PHX5-100 | 1,49 |
| 6 mm | 25 | PHX6-2 | 1,92 | PHX6-5 | 1,74 | PHX6-50 | 1,55 | PHX6-100 | 1,49 |
| 8 mm | 25 | PHX8-2 | 2,27 | PHX8-5 | 2,07 | PHX8-50 | 1,94 | PHX8-100 | 1,88 |

TRI
WING

| € x Inserto | | 2 U. | | 5 U. | | 50 U. | | 100 U. | |
|-------------|-------|---------|-------|---------|------|----------|------|-----------|------|
| | L1 mm | | € | | € | | € | | € |
| N°4 | 25 | PTRW4-2 | 11,45 | PTRW4-5 | 9,95 | PTRW4-50 | 8,96 | PTRW4-100 | 8,46 |
| N°5 | 25 | PTRW5-2 | 11,45 | PTRW5-5 | 9,95 | PTRW5-50 | 8,96 | PTRW5-100 | 8,46 |
| N°6 | 25 | PTRW6-2 | 11,45 | PTRW6-5 | 9,95 | PTRW6-50 | 8,96 | PTRW6-100 | 8,46 |
| N°8 | 25 | PTRW8-2 | 11,45 | PTRW8-5 | 9,95 | PTRW8-50 | 8,96 | PTRW8-100 | 8,46 |

XZN



| € x Inserto | | 2 U. | | 5 U. | | 50 U. | | 100 U. | |
|-------------|-------|----------|-------|----------|------|-----------|------|------------|------|
| | L1 mm | | € | | € | | € | | € |
| N°4 | 25 | PXZN4-2 | 7,02 | PXZN4-5 | 6,10 | PXZN4-50 | 5,49 | PXZN4-100 | 5,19 |
| N°5 | 25 | PXZN5-2 | 7,02 | PXZN5-5 | 6,10 | PXZN5-50 | 5,49 | PXZN5-100 | 5,19 |
| N°6 | 25 | PXZN6-2 | 7,02 | PXZN6-5 | 6,10 | PXZN6-50 | 5,49 | PXZN6-100 | 5,19 |
| N°8 | 25 | PXZN8-2 | 11,00 | PXZN8-5 | 9,58 | PXZN8-50 | 8,30 | PXZN8-100 | 8,14 |
| N°10 | 25 | PXZN10-2 | 11,00 | PXZN10-5 | 9,58 | PXZN10-50 | 8,30 | PXZN10-100 | 8,14 |

INSERTI INTERCAMBIABILI PER AVVITATORE



50mm
LUNG.
TOTALE
(L)



Inserti per Avvitatore

Rosa

PHILLIPS



| € x Insetto | | 2 U. | | 5 U. | | 50 U. | |
|-------------|-------|----------|-------------|----------|-------------|-----------|-------------|
| | L1 mm | | € | | € | | € |
| Ph 1 | 50 | Ph1X50-2 | 3,14 | Ph1X50-5 | 2,74 | Ph1X50-50 | 2,46 |
| Ph 2 | 50 | Ph2X50-2 | 3,14 | Ph2X50-5 | 2,74 | Ph2X50-50 | 2,46 |
| Ph 3 | 50 | Ph3X50-2 | 3,14 | Ph3X50-5 | 2,74 | Ph3X50-50 | 2,46 |
| Ph 4 | 50 | Ph4X50-2 | - | Ph4X50-5 | - | Ph4X50-50 | - |

POZIDRIV



| € x Insetto | | 2 U. | | 5 U. | | 50 U. | |
|-------------|-------|----------|-------------|----------|-------------|-----------|-------------|
| | L1 mm | | € | | € | | € |
| Pz 1 | 50 | Pz1X50-2 | 3,14 | Pz1X50-5 | 2,74 | Pz1X50-50 | 2,46 |
| Pz 2 | 50 | Pz2X50-2 | 3,14 | Pz2X50-5 | 2,74 | Pz2X50-50 | 2,46 |
| Pz 3 | 50 | Pz3X50-2 | 3,14 | Pz3X50-5 | 2,74 | Pz3X50-50 | 2,46 |
| Pz 4 | 50 | Pz4X50-2 | - | Pz4X50-5 | - | Pz4X50-50 | - |

TESTA PIATTA



| € x Insetto | | 2 U. | | 5 U. | | 50 U. | |
|-------------|-------|---------------|--------------|---------------|--------------|----------------|--------------|
| | L1 mm | | € | | € | | € |
| 0,5X4,0 | 50 | P0,5X4,0X50-2 | 4,90 | P0,5X4,0X50-5 | 4,26 | P0,5X4,0X50-50 | 3,81 |
| 0,5X3,0 | 50 | P0,5X3,0X50-2 | 4,90 | P0,5X3,0X50-5 | 4,26 | P0,5X3,0X50-50 | 3,81 |
| 0,6X3,5 | 50 | P0,6X3,5X50-2 | 4,90 | P0,6X3,5X50-5 | 4,26 | P0,6X3,5X50-50 | 3,81 |
| 0,6X4,5 | 50 | P0,6X4,5X50-2 | 4,90 | P0,6X4,5X50-5 | 4,26 | P0,6X4,5X50-50 | 3,81 |
| 0,8X4,0 | 50 | P0,8X4,0X50-2 | 4,90 | P0,8X4,0X50-5 | 4,26 | P0,8X4,0X50-50 | 3,81 |
| 0,8X5,0 | 50 | P0,8X5,0X50-2 | 4,90* | P0,8X5,0X50-5 | 4,26* | P0,8X5,0X50-50 | 3,81* |
| 0,8X5,5 | 50 | P0,8X5,5X50-2 | 4,90 | P0,8X5,5X50-5 | 4,26 | P0,8X5,5X50-50 | 3,81 |
| 1,0X5,5 | 50 | P1X5,5X50-2 | 4,90 | P1X5,5X50-5 | 4,26 | P1X5,5X50-50 | 3,81 |
| 1,0X6,0 | 50 | P1X6,0X50-2 | 4,90 | P1X6,0X50-5 | 4,26 | P1X6,0X50-50 | 3,81 |
| 1,2X6,5 | 50 | P1,2X6,5X50-2 | 4,90 | P1,2X6,5X50-5 | 4,26 | P1,2X6,5X50-50 | 3,81 |
| 1,2X8,0 | 50 | P1,2X8,0X50-2 | 4,90 | P1,2X8,0X50-5 | 4,26 | P1,2X8,0X50-50 | 3,81 |

*Fino ad esaurimento scorte

INSERTI INTERCAMBIABILI PER AVVITATORE

Inserti per Avvitatore

Rosa



TORX



€ x Insetto 2 U. 5 U. 50 U.

| | L1 mm | | € | | € | | € |
|------|----------|-----------|------|-----------|------|------------|------|
| T 5 | 50 | PT5X50-2 | 6,28 | PT5X50-5 | 5,47 | PT5X50-50 | 4,95 |
| T 6 | 50 | PT6X50-2 | 6,28 | PT6X50-5 | 5,47 | PT6X50-50 | 4,95 |
| T 7 | 50 | PT7X50-2 | 6,28 | PT7X50-5 | 5,47 | PT7X50-50 | 4,95 |
| T 8 | 50 | PT8X50-2 | 6,28 | PT8X50-5 | 5,47 | PT8X50-50 | 4,95 |
| T 9 | 50 | PT9X50-2 | 6,28 | PT9X50-5 | 5,47 | PT9X50-50 | 4,95 |
| T 10 | 50 | PT10X50-2 | 5,79 | PT10X50-5 | 5,03 | PT10X50-50 | 4,53 |
| T 15 | 50 | PT15X50-2 | 5,79 | PT15X50-5 | 5,03 | PT15X50-50 | 4,53 |
| T 20 | 50 | PT20X50-2 | 5,79 | PT20X50-5 | 5,03 | PT20X50-50 | 4,53 |
| T 25 | 50 | PT25X50-2 | 5,79 | PT25X50-5 | 5,03 | PT25X50-50 | 4,53 |
| T 27 | 50 | PT27X50-2 | 5,79 | PT27X50-5 | 5,03 | PT27X50-50 | 4,53 |
| T 30 | 50 | PT30X50-2 | 5,79 | PT30X50-5 | 5,03 | PT30X50-50 | 4,53 |
| T 40 | 50 | PT40X50-2 | 5,79 | PT40X50-5 | 5,03 | PT40X50-50 | 4,53 |

TESTA QUADRA
ROBERTSON

€ x Insetto 2 U. 5 U. 50 U.

| | L1 mm | | € | | € | | € |
|-----|----------|----------|------|----------|------|-----------|------|
| N°1 | 50 | PC1X50-2 | 7,54 | PC1X50-5 | 6,56 | PC1X50-50 | 5,91 |
| N°2 | 50 | PC2X50-2 | 7,54 | PC2X50-5 | 6,56 | PC2X50-50 | 5,91 |
| N°3 | 50 | PC3X50-2 | 7,54 | PC3X50-5 | 6,56 | PC3X50-50 | 5,91 |

ESAGONALE



€ x Insetto 2 U. 5 U. 50 U.

| | L1 mm | | € | | € | | € |
|--------|----------|-------------|------|-------------|------|--------------|------|
| 2 mm | 50 | PHX2X50-2 | 6,11 | PHX2X50-5 | 5,31 | PHX2X50-50 | 4,78 |
| 2,5 mm | 50 | PHX2,5X50-2 | 6,11 | PHX2,5X50-5 | 5,31 | PHX2,5X50-50 | 4,78 |
| 3 mm | 50 | PHX3X50-2 | 6,11 | PHX3X50-5 | 5,31 | PHX3X50-50 | 4,78 |
| 4 mm | 50 | PHX4X50-2 | 6,11 | PHX4X50-5 | 5,31 | PHX4X50-50 | 4,78 |
| 5 mm | 50 | PHX5X50-2 | 6,11 | PHX5X50-5 | 5,31 | PHX5X50-50 | 4,78 |
| 6 mm | 50 | PHX6X50-2 | 6,11 | PHX6X50-5 | 5,31 | PHX6X50-50 | 4,78 |
| 8 mm | 50 | PHX8X50-2 | 7,82 | PHX8X50-5 | 7,17 | PHX8X50-50 | 6,13 |

INSERTI INTERCAMBIABILI PER AVVITATORE

Inserti per Avvitatore
Rosa



70mm
LUNG.
TOTALE
(L.)



PHILLIPS



€ x Bit

2 Uds

5 Uds

| | L1 mm | | € | | € |
|------|----------|----------|-------------|----------|-------------|
| Ph 1 | 70 | Ph1X70-2 | 7,37 | Ph1X70-5 | 6,41 |
| Ph 2 | 70 | Ph2X70-2 | 7,37 | Ph2X70-5 | 6,41 |
| Ph 3 | 70 | Ph3X70-2 | 7,37 | Ph3X70-5 | 6,41 |
| Ph 4 | 70 | Ph4X70-2 | - | Ph4X70-5 | - |

POZIDRIV



€ x Bit

2 Uds

5 Uds

| | L1 mm | | € | | € |
|------|----------|----------|-------------|----------|-------------|
| Pz 1 | 70 | Pz1X70-2 | 7,37 | Pz1X70-5 | 6,41 |
| Pz 2 | 70 | Pz2X70-2 | 7,37 | Pz2X70-5 | 6,41 |
| Pz 3 | 70 | Pz3X70-2 | 7,37 | Pz3X70-5 | 6,41 |
| Pz 4 | 70 | Pz4X70-2 | - | Pz4X70-5 | - |



90mm
LUNG.
TOTALE
(L.)



PHILLIPS



€ x Bit

2 Uds

5 Uds

| | L1 mm | | € | | € |
|------|----------|----------|-------------|----------|-------------|
| Ph 1 | 90 | Ph1X90-2 | 9,09 | Ph1X90-5 | 7,91 |
| Ph 2 | 90 | Ph2X90-2 | 9,09 | Ph2X90-5 | 7,91 |
| Ph 3 | 90 | Ph3X90-2 | 9,09 | Ph3X90-5 | 7,91 |
| Ph 4 | 90 | Ph4X90-2 | - | Ph4X90-5 | - |

POZIDRIV



€ x Bit

2 Uds

5 Uds

| | L1 mm | | € | | € |
|------|----------|----------|-------------|----------|-------------|
| Pz 1 | 90 | Pz1X90-2 | 9,09 | Pz1X90-5 | 7,91 |
| Pz 2 | 90 | Pz2X90-2 | 9,09 | Pz2X90-5 | 7,91 |
| Pz 3 | 90 | Pz3X90-2 | 9,09 | Pz3X90-5 | 7,91 |
| Pz 4 | 90 | Pz4X90-2 | - | Pz4X90-5 | - |

INSERTI INTERCAMBIABILI PER AVVITATORE

TiN

25mm
LUNG.
TOTALE
(L)

PHILLIPS



| € x Insetto | | 2 U. | | 5 U. | | 50 U. | |
|-------------|----------|--------|------|--------|------|---------|------|
| | L1 mm | | € | | € | | € |
| Ph 1 | 25 | Ph1T-2 | 3,71 | Ph1T-5 | 2,80 | Ph1T-50 | 2,52 |
| Ph 2 | 25 | Ph2T-2 | 3,71 | Ph2T-5 | 2,80 | Ph2T-50 | 2,52 |
| Ph 3 | 25 | Ph3T-2 | 3,71 | Ph3T-5 | 2,80 | Ph3T-50 | 2,52 |

POZIDRIV



| € x Insetto | | 2 U. | | 5 U. | | 50 U. | |
|-------------|----------|--------|------|--------|------|---------|------|
| | L1 mm | | € | | € | | € |
| Pz 1 | 25 | Pz1T-2 | 3,71 | Pz1T-5 | 2,80 | Pz1T-50 | 2,52 |
| Pz 2 | 25 | Pz2T-2 | 3,71 | Pz2T-5 | 2,80 | Pz2T-50 | 2,52 |
| Pz 3 | 25 | Pz3T-2 | 3,71 | Pz3T-5 | 2,80 | Pz3T-50 | 2,52 |

TESTA PIATTA



| € x Insetto | | 2 U. | | 5 U. | | 50 U. | |
|-------------|----------|-------------|------|-------------|------|--------------|------|
| | L1 mm | | € | | € | | € |
| 0,6X4,5 | 25 | P0,6X4,5T-2 | 3,97 | P0,6X4,5T-5 | 3,45 | P0,6X4,5T-50 | 3,10 |
| 0,8X5,5 | 25 | P0,8X5,5T-2 | 3,97 | P0,8X5,5T-5 | 3,45 | P0,8X5,5T-50 | 3,10 |
| 1,0X5,5 | 25 | P1X5,5T-2 | 3,97 | P1X5,5T-5 | 3,45 | P1X5,5T-50 | 3,10 |
| 1,2X6,5 | 25 | P1,2X6,5T-2 | 3,97 | P1,2X6,5T-5 | 3,45 | P1,2X6,5T-50 | 3,10 |

TORX



| € x Insetto | | 2 U. | | 5 U. | | 50 U. | |
|-------------|----------|---------|------|---------|------|----------|------|
| | L1 mm | | € | | € | | € |
| T 10 | 25 | PT10T-2 | 4,02 | PT10T-5 | 3,51 | PT10T-50 | 3,15 |
| T 15 | 25 | PT15T-2 | 4,02 | PT15T-5 | 3,51 | PT15T-50 | 3,15 |
| T 20 | 25 | PT20T-2 | 4,02 | PT20T-5 | 3,51 | PT20T-50 | 3,15 |
| T 25 | 25 | PT25T-2 | 4,02 | PT25T-5 | 3,51 | PT25T-50 | 3,15 |
| T 27 | 25 | PT27T-2 | 4,02 | PT27T-5 | 3,51 | PT27T-50 | 3,15 |
| T 30 | 25 | PT30T-2 | 4,02 | PT30T-5 | 3,51 | PT30T-50 | 3,15 |
| T 40 | 25 | PT40T-2 | 4,02 | PT40T-5 | 3,51 | PT40T-50 | 3,15 |

INSERTI INTERCAMBIABILI PER AVVITATORE

TiN



50mm
LUNG.
TOTALE
(L)



PHILLIPS



| € x Insetto | | 2 U. | | 5 U. | | 50 U. | |
|-------------|-------|-----------|-------------|-----------|-------------|------------|-------------|
| | L1 mm | | € | | € | | € |
| Ph 1 | 50 | Ph1Tx50-2 | 8,56 | Ph1Tx50-5 | 7,44 | Ph1Tx50-50 | 6,67 |
| Ph 2 | 50 | Ph2Tx50-2 | 8,56 | Ph2Tx50-5 | 7,44 | Ph2Tx50-50 | 6,67 |
| Ph 3 | 50 | Ph3Tx50-2 | 8,56 | Ph3Tx50-5 | 7,44 | Ph3Tx50-50 | 6,67 |

POZIDRIV



| € x Insetto | | 2 U. | | 5 U. | | 50 U. | |
|-------------|-------|-----------|-------------|-----------|-------------|------------|-------------|
| | L1 mm | | € | | € | | € |
| Pz 1 | 50 | Pz1Tx50-2 | 8,56 | Pz1Tx50-5 | 7,44 | Pz1Tx50-50 | 6,67 |
| Pz 2 | 50 | Pz2Tx50-2 | 8,56 | Pz2Tx50-5 | 7,44 | Pz2Tx50-50 | 6,67 |
| Pz 3 | 50 | Pz3Tx50-2 | 8,56 | Pz3Tx50-5 | 7,44 | Pz3Tx50-50 | 6,67 |

TORX



| € x Insetto | | 2 U. | | 5 U. | | 50 U. | |
|-------------|-------|------------|--------------|------------|--------------|-------------|-------------|
| | L1 mm | | € | | € | | € |
| T 10 | 50 | PT10Tx50-2 | 12,13 | PT10Tx50-5 | 10,54 | PT10Tx50-50 | 9,48 |
| T 15 | 50 | PT15Tx50-2 | 12,13 | PT15Tx50-5 | 10,54 | PT15Tx50-50 | 9,48 |
| T 20 | 50 | PT20Tx50-2 | 12,13 | PT20Tx50-5 | 10,54 | PT20Tx50-50 | 9,48 |
| T 25 | 50 | PT25Tx50-2 | 12,13 | PT25Tx50-5 | 10,54 | PT25Tx50-50 | 9,48 |
| T 27 | 50 | PT27Tx50-2 | 12,13 | PT27Tx50-5 | 10,54 | PT27Tx50-50 | 9,48 |
| T 30 | 50 | PT30Tx50-2 | 12,13 | PT30Tx50-5 | 10,54 | PT30Tx50-50 | 9,48 |
| T 40 | 50 | PT40Tx50-2 | 12,13 | PT40Tx50-5 | 10,54 | PT40Tx50-50 | 9,48 |

PORTAINSERI MAGNETICI

PORTAINSERI MAGNETICI

| | L1 mm | TIPO DI CODOLO | € |
|-----------|----------|------------------------|--------|
| PMGx51 | 51 | MAGNETICO SENZA ANELLO | 6,94 |
| PMGx58 | 58 | MAGNETICO SENZA ANELLO | 7,12 |
| PMGx74 | 74 | MAGNETICO CON ANELLO | 12,54 |
| PMGx100 | 100 | MAGNETICO CON ANELLO | 14,48 |
| PMGx150 | 150 | MAGNETICO CON ANELLO | 16,01 |
| PMGx200 | 200 | MAGNETICO CON ANELLO | 19,09 |
| PMGx250 | 250 | MAGNETICO CON ANELLO | 29,36 |
| PMGSDSx78 | 78 | SDS PLUS | 25,94 |
| PBERx74 | 74 | BERILIO | 53,84* |
| PDESSx70 | 70 | 5/16" DESSOUTTER | 33,17* |
| P7x74 | 74 | 7mm Fein | 36,04* |

*Fino ad esaurimento scorte



Ref. PMGSDSX78

Ref. PMGX74

Ref. PMGX100

PORTAINSERI MAGNETICO A CAMBIO RAPIDO (ADATTO PER INSERTI DI 1/4" CON COLLO)

| | L1 mm | TIPO DI CODOLO | € |
|-----------|----------|--|-------|
| PCRX60 | 60 | Cambio rapido 1/4" Adatto per inserti di 1/4" con collo | 18,65 |
| PCRX74 | 74 | Cambio rapido 1/4" Adatto per inserti di 1/4" con collo | 19,22 |
| PCRSDSX80 | 80 | SDS PLUS | 37,81 |



Ref. PCRSDSX80

Ref. PCRX60

PORTAINSERI MAGNETICO CON ANELLO MAGNETICO FRONTALE SUPPLEMENTARE PER FISSAGGIO DI VITI



Ref. PCTX60

1. Collare regolabile.
2. Anello magnetico frontale per fissaggio di viti.
3. Anello magnetico per fissaggio dell'inserto.

| | L1 mm | TIPO DI CODOLO | € |
|--------|----------|------------------------------------|-------|
| PCTX60 | 60 | Portainseri con collare regolabile | 17,57 |



Ref. PCTX60

BUSSOLE MAGNETICHE ESAGONALI

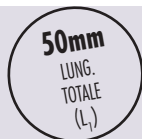

BUSSOLE MAGNETICHE ESAGONALI



| | mm | " | | € / 1U. |
|-------------|------|------------|---|---------|
| PLIHX5-2 | 5,0 | | 2 | 6,85 |
| PLIHX5,5-2 | 5,5 | | 2 | 6,85 |
| PLIHX6-2 | 6,0 | | 2 | 6,85 |
| PLIHX1/4-2 | | 1/4"=6,35 | 2 | 6,85 |
| PLIHX7-2 | 7,0 | | 2 | 7,00 |
| PLIHX5/16-2 | | 5/16"=7,93 | 2 | 7,00 |
| PLIHX8-2 | 8,0 | | 2 | 7,00 |
| PLIHX3/8-2 | | 3/8"=9,52 | 2 | 7,00 |
| PLIHX10-2 | 10,0 | | 2 | 7,16 |
| PLIHX11-2 | 11,0 | | 2 | 7,16 |
| PLIHX12-2 | 12,0 | | 2 | 7,16 |
| PLIHX13-2 | 13,0 | | 2 | 7,16 |

SET DI 7 PEZZI DI BUSSOLE MAGNETICHE ESAGONALI

| REFERENZA | EPLL |
|-----------|---|
| N° PEZZI | 7 |
| CONTENUTO | HX1/4 - HX7 - HX8 - HX3/8 HX10 - HX12 - HX13 |
| P.V.P. € | 49,34 |



GIRAVITE A CRICCHETTO CON STOCCAGGIO DI INSERTI ED ESPOSITORE PER GIRAVITI

Plus

1. Alta qualità e rendimento.
2. Rotazione a destra e a sinistra.
3. Telescopico regolabile in lunghezza.
4. Fabbricato in acciaio e plastica ad alta resistenza.

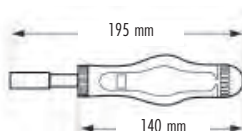

DTRC

- Contenuto del giravite
- PH1 - PH2
 - PZ1 - PZ2
 - T15 - T20 - T25 - T30

37,49 €

SET DI INSERTI INTERCAMBIABILI PER AVVITATORE

SET DI 7 PEZZI QUALITÀ PLUS E TiN



Ref. EPT1

| REFERENZA | EPT1 | EPT2 | EPT3 |
|-----------|---|---|--|
| N° PEZZI | 7 | 7 | 7 |
| CONTENUTO | PH1 - PH2 PZ1 - PZ2 0,8x5,5 - 1,2x6,5 1Portainseriti PMG | T10 - T15 T20 - T25 T30 - T40 1Portainseriti PMG | PH1 - PH2 - PH3 PZ1 - PZ2 - PZ3 1Portainseriti PMG |
| P.V.P. € | 13,03 | 17,58 | 15,63 |





Ref. EPTT1

| REFERENZA | EPTT1 | EPTT2 | EPTT3 |
|-----------|---|---|--|
| N° PEZZI | 7 | 7 | 7 |
| CONTENUTO | PH1 - PH2 PZ1 - PZ2 0,8x5,5 - 1,2x6,5 1Portainseriti PMG | T10 - T15 T20 - T25 T30 - T40 1Portainseriti PMG | PH1 - PH2 - PH3 PZ1 - PZ2 - PZ3 1Portainseriti PMG |
| P.V.P. € | 37,00 | 42,90 | 35,67 |

SET DI INSERTI INTERCAMBIABILI PER AVVITATORE

SET DI 12 PEZZI QUALITÀ PLUS E TiN

| | | | |
|---|-------------|---|---|
|  | REFERENZA | EPT4 | |
| | N° PEZZI | 12 | |
| | CONTENUTO | <ul style="list-style-type: none"> ⊕ PH1 - PH2(2) - PH3 ⊕ PZ1 - PZ2(2) - PZ3 ⊖ 0,6x4,5 - 0,8x5,5 - 1,2x6,5 1 Portainseriti PMG | <ul style="list-style-type: none"> ⊕ T10 - T15(2) ⊕ T20(2) - T25(2) ⊕ T27 - T30(2) - T40 1 Portainseriti PMG |
| | Plus | | |
| Ref. EPT4 | P.V.P. € | 17,48 | 24,01 |

| | | | |
|---|------------|---|---|
|  | REFERENZA | EPTT4 | |
| | N° PEZZI | 12 | |
| | CONTENUTO | <ul style="list-style-type: none"> ⊕ PH1 - PH2(2) - PH3 ⊕ PZ1 - PZ2(2) - PZ3 ⊖ 0,6x4,5 - 0,8x5,5 - 1,2x6,5 1 Portainseriti PCT | <ul style="list-style-type: none"> ⊕ T10 - T15(2) ⊕ T20(2) - T25(2) ⊕ T27 - T30(2) - T40 1 Portainseriti PCT |
| | TiN | | |
| Ref. EPTT4 | P.V.P. € | 46,58 | 54,81 |

SET DI 31 PEZZI QUALITÀ PLUS E TiN

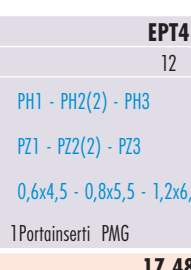
| | | | |
|---|-------------|---|---|
|  | REFERENZA | EPT6 | |
| | N° PEZZI | 31 | |
| | CONTENUTO | <ul style="list-style-type: none"> ⊕ PH1(3) - PH2(3) - PH3(3) ⊕ PZ1(3) - PZ2(3) - PZ3(3) ⊖ 0,6x4,5 - 0,8x5,5 - 1,2x6,5 1 Portainseriti PMG | <ul style="list-style-type: none"> ⊕ T10 - T15 - T20 - T25 - T30 - T40 ⊕ H3 - H4 - H5 1 Portainseriti PMG |
| | Plus | | |
| Ref. EPT6 | P.V.P. € | 50,00 | |

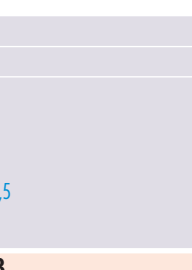
| | | | |
|--|------------|---|---|
|  | REFERENZA | EPTT6 | |
| | N° PEZZI | 31 | |
| | CONTENUTO | <ul style="list-style-type: none"> ⊕ PH1(3) - PH2(3) - PH3(3) ⊕ PZ1(3) - PZ2(3) - PZ3(3) ⊖ 0,6x4,5 - 0,8x5,5 - 1,2x6,5 1 Portainseriti PCT | <ul style="list-style-type: none"> ⊕ T10 - T15 - T20 - T25 - T30 - T40 ⊕ H3 - H4 - H5 1 Portainseriti PCT |
| | TiN | | |
| | P.V.P. € | 106,07 | |

SET DI 36 PEZZI QUALITÀ PLUS E TiN

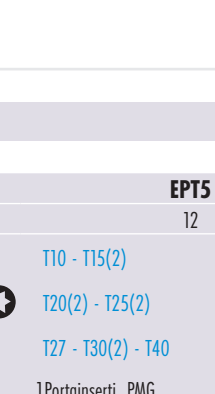
| | | | |
|---|-------------|---|---|
|  | REFERENZA | EPT7 | |
| | N° PEZZI | 36 | |
| | CONTENUTO | <ul style="list-style-type: none"> ⊕ PH1(3) - PH2(3) - PH3(3) ⊕ PZ1(3) - PZ2(3) - PZ3(3) ⊖ 0,5 x 4 - 0,6 x 4,5 - 0,8 x 5 - 0,8 x 5,5 - 1 x 6 - 1,2 x 6,5 - 1,2 x 8 1 Portainseriti PMG | <ul style="list-style-type: none"> ⊕ T10 - T15 - T20 - T25 - T27 - T30 - T40 ⊕ H2 - H2,5 - H3 - H4 - H5 - H6 - H8 1 Portainseriti PMG |
| | Plus | | |
| Ref. EPT7 | P.V.P. € | 63,30 | |

| | | | |
|---|------------|---|---|
|  | REFERENZA | EPTT7* | |
| | N° PEZZI | 36 | |
| | CONTENUTO | <ul style="list-style-type: none"> ⊕ PH1(3) - PH2(3) - PH3(3) ⊕ PZ1(3) - PZ2(3) - PZ3(3) ⊖ 0,5 x 4 - 0,6 x 4,5 - 0,8 x 5 - 0,8 x 5,5 - 1 x 6 - 1,2 x 6,5 - 1,2 x 8 1 Portainseriti PCT | <ul style="list-style-type: none"> ⊕ T10 - T15 - T20 - T25 - T27 - T30 - T40 ⊕ H2 - H2,5 - H3 - H4 - H5 - H6 - H8 1 Portainseriti PCT |
| | TiN | | |
| Ref. EPTT7 | P.V.P. € | 129,90* | |

*Fino ad esaurimento scorte

SET DI INSERTI INTERCAMBIABILI PER AVVITATORE

SET DI 45 E 80 PEZZI QUALITÀ *Plus*

Inserti per Avvitatore

Rosa



Ref. EPT45



Ref. EPT80



| REFERENZA | EPT45 | |
|-----------|---|---|
| N° PEZZI | 45 | |
| CONTENUTO | <ul style="list-style-type: none"> PH1(2) - PH2(2) - PH3(2) PZ1(2) - PZ2(2) - PZ3(2) 0,5x3-0,6x4,5-0,8x5,5(2)-1,2x6,5-1,6x8 H2,5 - H3 - H4 - H5 - H6 - H7 T10 - T15 - T20 - T25 - T30 - T40 | <ul style="list-style-type: none"> Chiavi di bussole esagonali (mm): 5 - 6 - 7 - 8 - 9 - 10 - 11 - 12 - 13 - 14 1 Adattatore per bussole 1 Adattatore per inserti 1 Portainseri Magnetico PCR 1 Chiave a cricchetto con 72 denti 1 Giravite |
| P.V.P. € | 158,41 | |

| REFERENZA | EPT80* | |
|-----------|---|--|
| N° PEZZI | 80 | |
| CONTENUTO | <ul style="list-style-type: none"> PH0 - PH1 - PH2(4) - PH3(2) PZ1 - PZ2(4) - PZ3(2) 0,5x3-0,6x4,5-0,8x5,5(2)-1,2x6,5-1,6x8 H2 - H2,5 - H3 - H4 - H5 - H6 - H7 - H8 TW1 - TW2 - TW3 - TW4 - TW5 TQ5 - TQ6 - TQ8 - TQ10 T5 - T6 - T7 - T8 - T9 - T10 - T15 T20(2) - T25(2) - T27 - T30 - T40 TS10 - TS15 - TS20 - TS25 - TS30 - TS40 | <ul style="list-style-type: none"> CO - C1 - C2 - C3 SP4 - SP6 - SP8 - SP10 HS3 - HS4 - HS5 - HS6 1 Portainseri Magnetico PCR 1 Giravite PH1 - PH2 PZ1 - PZ2 T15 - T20 - T25 - T30 |
| P.V.P. € | 155,24* | |

*Fino ad esaurimento scorte

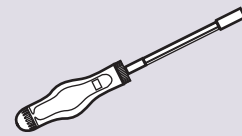

ESTRATTORI A MACCHINA PER VITI ROTTE

MICRO GRABIT

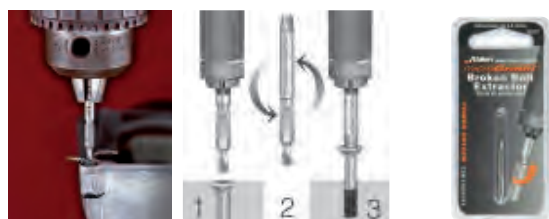

| | | EP |
|--------|----|-------|
| | | € |
| EP451C | M3 | 55,10 |
| EP452C | M4 | 55,10 |
| EP453C | M5 | 55,10 |
| EP454C | M6 | 55,10 |

1. Perforare la vite.
2. Girare.
3. Estrarre.

PRO GRABIT CON CORPO ESAGONALE 1/4"



| | | EP |
|---------|-----|-------|
| | | € |
| EP8401C | M5 | 43,70 |
| EP8402C | M6 | 51,63 |
| EP8403C | M8 | 51,63 |
| EP8404C | M10 | 54,18 |

1. Perforare la vite.
2. Girare.
3. Estrarre.

DRILL-OUT ESTRATTORE DI VITI ROTTE CON PUNTA PILOTA (M6-M12)



| | | EP |
|--------|-----|-------|
| | | € |
| EP205C | M6 | 53,42 |
| EP312C | M8 | 64,73 |
| EP375C | M10 | 64,73 |
| EP500C | M12 | 72,86 |

X-OUT ESTRATTORE DI VITI ROTTE CON CODOLO ESAGONALE (M3-M5)



| | | EP |
|---------|----|-------|
| | | € |
| EP3701C | M3 | 43,70 |
| EP3702C | M4 | 43,70 |
| EP3703C | M5 | 48,57 |

SERIE DI ESTRATTORI A MACCHINA PER VITI ROTTE

| | |
|------------|-------------|
| REFERENCIA | EP450C |
| Nº PIEZAS | 4 |
| CONTENIDO | M3-M4-M5-M6 |
| P.V.P. € | 226,00 |



| | |
|------------|---------------|
| REFERENCIA | EP401C |
| Nº PIEZAS | 4 |
| CONTENIDO | M6-M8-M10-M12 |
| P.V.P. € | 265,87 |



ESTRATTORI A MANO LAMINATI PER VITI ROTTE

SERIE DI ESTRATTORI CLASSICI PER VITI

Realizzare un foro centrale con la punta Blue-Master raccomandata; introdurre l'estrattore nel foro, girare l'estrattore verso sinistra fino ad estrarre la vite.

| REFERENZA | EX/1-5 | EX/1-6 | EX/1-8 |
|-----------|----------|----------|----------|
| N° PEZZI | 5 | 6 | 8 |
| CONTENUTO | M3 - M18 | M3 - M24 | M3 - M45 |
| P.V.P. € | 22,96 | 31,07 | 71,73 |

Ref. EX/1-6



Inserti per Avvitatore

Rosa



| | Per VITI | mm | mm | L1 mm | Ø min mm | Ø max. mm | EX € |
|------|-----------|------|------|-------|----------|-----------|-------|
| EX/1 | M3 - M6 | 3,2 | 2,5 | 51 | 1,75 | 3,95 | 3,06 |
| EX/2 | M6 - M8 | 4,0 | 3,0 | 60 | 2,20 | 4,80 | 3,06 |
| EX/3 | M8 - M11 | 5,1 | 4,5 | 68 | 3,30 | 6,40 | 3,60 |
| EX/4 | M11 - M14 | 6,2 | 6,0 | 76 | 4,75 | 8,40 | 4,47 |
| EX/5 | M14 - M18 | 8,6 | 8,0 | 86 | 6,35 | 11,00 | 5,82 |
| EX/6 | M18 - M24 | 12,0 | 11,0 | 95 | 9,50 | 15,00 | 9,82 |
| EX/7 | M24 - M33 | 15,9 | 14,0 | 105 | 12,70 | 19,00 | 26,63 |
| EX/8 | M33 - M45 | 20,0 | 21,0 | 111 | 19,00 | 25,00 | 43,60 |

| REFERENZA | EXTT |
|-----------------------------|---|
| N° PEZZI | 10 |
| ESTRATTORI PUNTE PRECEDENTI | EX/1-EX/2-EX/3-EX/4-EX/5 Ref. BC3 Ø2,5-3-4,5-6-8 |
| P.V.P. € | 40,87 |

ESTRATTORI A MANO PER VITI ROTTE



| | Per VITI | mm | mm | L1 mm | Ø min mm | Ø max. mm | EFX € |
|-------|----------|------|------|-------|----------|-----------|-------|
| EFX/1 | M3-M6 | 2,9 | 2,0 | 50 | 1,9 | 3,2 | 3,85 |
| EFX/2 | M6-M8 | 3,9 | 3,2 | 60 | 2,8 | 5,0 | 3,85 |
| EFX/3 | M8-M11 | 4,8 | 4,0 | 68 | 3,2 | 6,5 | 4,56 |
| EFX/4 | M11-M14 | 6,7 | 6,4 | 75 | 5,2 | 9,0 | 5,67 |
| EFX/5 | M14-M18 | 8,5 | 7,1 | 85 | 6,4 | 11,0 | 7,35 |
| EFX/6 | M18-M25 | 11,8 | 9,5 | 95 | 9,4 | 15,0 | 12,43 |
| EFX/7 | M25-M35 | 14,3 | 12,7 | 106 | 12,8 | 19,0 | 33,68 |
| EFX/8 | M35-M45 | 19,5 | 19,5 | 110 | 19,3 | 25,0 | 55,17 |

Ref. EFX/1-5



| REFERENZA | EFX/1-5 |
|-----------|----------|
| N° PEZZI | 5 |
| CONTENUTO | M3 - M18 |
| P.V.P. € | 29,49 |

PUNTE PER METALLO EXTRA CORTE

Ref. BH2

HSS



118°



OX



| | Ø mm | L1 x L2 mm | mm | BH2 € |
|---------|-------|------------|------|-------|
| BH20200 | 2,00 | 61 x 33 | 1/4" | 6,00 |
| BH20300 | 3,00 | 61 x 33 | 1/4" | 6,00 |
| BH20400 | 4,00 | 75 x 43 | 1/4" | 6,95 |
| BH20500 | 5,00 | 86 x 52 | 1/4" | 8,64 |
| BH20600 | 6,00 | 93 x 57 | 1/4" | 9,32 |
| BH20700 | 7,00 | 109 x 69 | 1/4" | 11,74 |
| BH20800 | 8,00 | 117 x 75 | 1/4" | 13,19 |
| BH20900 | 9,00 | 125 x 81 | 1/4" | 14,84 |
| BH21000 | 10,00 | 133 x 87 | 1/4" | 16,51 |

| REFERENZA | BH29335 | BH29333 |
|-----------|----------------|-----------------------|
| N° PUNTE | 5 | 8 |
| QUALITÀ | HSS | HSS |
| CONTENUTO | Ø 3-4-5-6-8 mm | Ø 3-4-5-6-7-8-9-10 mm |
| P.V.P. € | 53,15 | 71,10 |



UTENSILI A CODOLO ESAGONALE 1/4"

PUNTA PER METALLO EXTRA CORTA

HSS-G

Ref. BC59

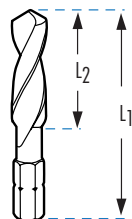

PUNTE-MASCHI SVASATORI

HSS-G

Ref. MAHM

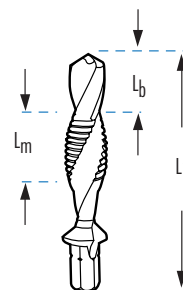

| | Ø mm | L1 x L2 mm | | BC59 € | BC59CR € |
|----------|---------|---------------|------|-----------|-------------|
| BC590100 | 1,00 | 34 x 12 | 1/4" | 7,21 | - |
| BC590150 | 1,50 | 34 x 12 | 1/4" | 7,21 | - |
| BC590200 | 2,00 | 34 x 12 | 1/4" | 7,21 | 7,21 |
| BC590250 | 2,50 | 36 x 14 | 1/4" | 7,21 | 7,21 |
| BC590300 | 3,00 | 38 x 16 | 1/4" | 7,21 | 7,21 |
| BC590330 | 3,30 | 40 x 18 | 1/4" | 7,21 | 7,21 |
| BC590350 | 3,50 | 40 x 18 | 1/4" | 7,21 | 7,21 |
| BC590400 | 4,00 | 44 x 20 | 1/4" | 7,21 | 7,21 |
| BC590420 | 4,20 | 45 x 20 | 1/4" | 7,21 | 7,21 |
| BC590450 | 4,50 | 46 x 24 | 1/4" | 7,21 | 7,21 |
| BC590500 | 5,00 | 50 x 26 | 1/4" | 7,21 | 7,21 |
| BC590550 | 5,50 | 50 x 26 | 1/4" | 7,53 | 7,53 |
| BC590600 | 6,00 | 50 x 26 | 1/4" | 7,53 | 7,53 |
| BC590650 | 6,50 | 50 x 30 | 1/4" | 7,53 | 7,53 |
| BC590680 | 6,80 | 50 x 30 | 1/4" | 7,53 | 7,53 |
| BC590700 | 7,00 | 50 x 30 | 1/4" | 7,53 | 7,53 |
| BC590750 | 7,50 | 51 x 32 | 1/4" | 8,80 | 8,80 |
| BC590800 | 8,00 | 51 x 32 | 1/4" | 8,80 | 8,80 |
| BC590850 | 8,50 | 53 x 33 | 1/4" | 8,80 | 8,80 |
| BC590900 | 9,00 | 53 x 33 | 1/4" | 10,14 | 10,14 |
| BC590950 | 9,50 | 54 x 38 | 1/4" | 10,14 | 10,14 |
| BC591000 | 10,00 | 54 x 38 | 1/4" | 10,14 | 10,14 |
| BC591020 | 10,20 | 54 x 38 | 1/4" | 10,14 | 10,14 |

| | L1 x Lb x Lm mm | | MAHM € | MAHMCR € |
|-------------|--------------------|------|-----------|-------------|
| | | | | |
| M 3 x 0,50 | 36 x 5 x 6 | 1/4" | 20,36 | 20,36 |
| M 4 x 0,70 | 39 x 6 x 7 | 1/4" | 20,36 | 20,36 |
| M 5 x 0,80 | 41 x 8 x 8 | 1/4" | 20,36 | 20,36 |
| M 6 x 1,00 | 44 x 8 x 10 | 1/4" | 20,36 | 20,36 |
| M 8 x 1,25 | 50 x 10 x 11 | 1/4" | 28,16 | 28,16 |
| M 10 x 1,50 | 59 x 11 x 11 | 1/4" | 33,96 | 33,96 |



| | |
|-----------------|-----------------|
| REFERENZA | MAH9327CR |
| N° PUNTE | 5 |
| REFERENZA PUNTE | MAHMCR |
| CONTENUTO | M4-M5-M6-M8-M10 |
| P.V.P. € | 143,56 |

MASCHI HSS-G

HSS-G

Ref. M

| | L1 x L2 mm | | M € | MCR € |
|-------------|---------------|------|--------|----------|
| | | | | |
| M 3 x 0,50 | 33 x 11 | 1/4" | 7,59 | 7,59 |
| M 4 x 0,70 | 35 x 12 | 1/4" | 7,59 | 7,59 |
| M 5 x 0,80 | 36 x 15 | 1/4" | 9,65 | 9,65 |
| M 6 x 1,00 | 39 x 18 | 1/4" | 9,65 | 9,65 |
| M 8 x 1,25 | 40 x 19 | 1/4" | 13,38 | 13,38 |
| M 10 x 1,50 | 41 x 21 | 1/4" | 16,53 | 16,53 |

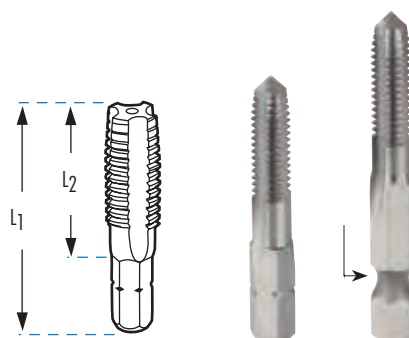

UTENSILI A CODOLO ESAGONALE 1/4"

BROCA MACHO HSSCo STEP CUT

NEW

DIN 13

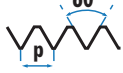

HSSCo
5%

BRILLANTE

TOL
6H

D
CODOLO
SOTTILE

1/4"

Ref. MTKM

STEP CUT

| | | | | | | | | | | MTKM |
|---|---------|--------|-------|-------|-------|-------|-------|-------|------|-------|
| | | Lb mm | Lm mm | L3 mm | L mm | Db mm | D2 mm | D3 mm | | € |
| M | 3x0,50 | D 7,0 | 6,0 | 6,0 | 57,0 | 2,5 | 2,2 | 7,3 | 1/4" | 23,41 |
| M | 4x0,70 | D 7,0 | 8,5 | 6,0 | 62,0 | 3,3 | 3,0 | 7,3 | 1/4" | 23,41 |
| M | 5x0,80 | D 9,0 | 10,0 | 6,0 | 69,0 | 4,2 | 3,7 | 7,3 | 1/4" | 23,41 |
| M | 6x1,00 | D 10,0 | 12,0 | 6,0 | 73,0 | 5,0 | 4,5 | 7,3 | 1/4" | 23,41 |
| M | 8x1,25 | D 12,0 | 16,0 | 6,0 | 87,0 | 6,8 | 6,3 | 9,4 | 1/4" | 32,39 |
| M | 10x1,50 | D 14,0 | 20,0 | 6,0 | 96,0 | 8,5 | 8,0 | 11,4 | 1/4" | 39,05 |
| M | 12x1,75 | D 16,0 | 24,0 | 8,0 | 112,0 | 10,3 | 9,8 | 13,4 | 1/4" | 56,36 |

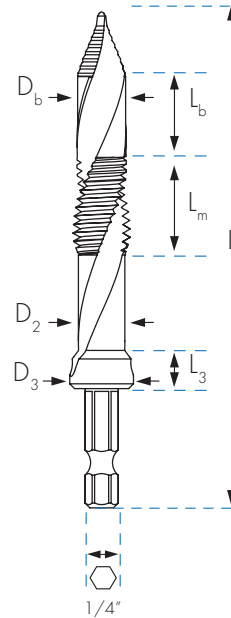

Inserti per Avvitatore

Rosa

SVASATORE A 3 TAGLIANTI

HSS-G

Ref. AV22

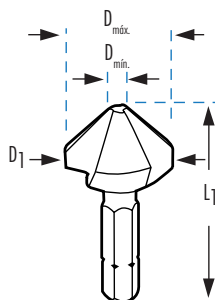

SVASATORE A SBAVARE

HSS



1/4"

Ref. AV1...CR

Ref. AV101CR
Ref. AV102CR



Ref. AV103CR
Ref. AV104CR

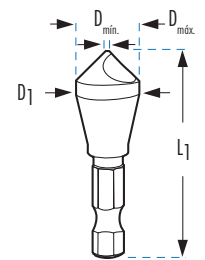

| | | | | | AV22 |
|-------|-------|--------------------|------|-------|------|
| D1 mm | L1 mm | D min. - D max. mm | | € | |
| 6,30 | 31 | 1,50 - 5,8 | 1/4" | 19,05 | |
| 8,30 | 31 | 2,00 - 7,8 | 1/4" | 19,05 | |
| 10,40 | 34 | 2,50 - 10,0 | 1/4" | 20,43 | |
| 12,40 | 35 | 2,80 - 12,0 | 1/4" | 21,80 | |
| 16,50 | 40 | 3,20 - 16,0 | 1/4" | 24,38 | |
| 20,50 | 41 | 3,50 - 20,0 | 1/4" | 26,78 | |

| | | | | | AV1...CR |
|---------|-------|-------|--------------------|------|----------|
| | D1 mm | L1 mm | D min. - D max. mm | € | |
| AV101CR | 10,00 | 40 | 2,0 - 5,0 | 1/4" | 19,32 |
| AV102CR | 14,00 | 42 | 5,0 - 10,0 | 1/4" | 24,14 |
| AV103CR | 17,00 | 45 | 5,0 - 13,0 | 1/4" | 43,25 |
| AV104CR | 25,00 | 55 | 7,0 - 20,0 | 1/4" | 77,25 |

UTENSILI A CODOLO ESAGONALE 1/4"

PUNTA PER MURO

Ref. BWH

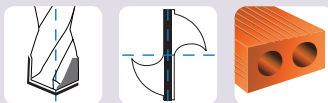



PUNTA PER LEGNO

Ref. BMH

CV



| | Ø mm | L1 x L2 mm |  | BWH € |
|-------|---------|---------------|---|----------|
| BWH03 | 3 | 70 x 30 | 1/4" | 3,39 |
| BWH04 | 4 | 70 x 30 | 1/4" | 3,66 |
| BWH05 | 5 | 85 x 45 | 1/4" | 3,97 |
| BWH06 | 6 | 100 x 50 | 1/4" | 4,42 |
| BWH07 | 7 | 100 x 50 | 1/4" | 5,19 |
| BWH08 | 8 | 120 x 70 | 1/4" | 6,00 |
| BWH09 | 9 | 120 x 70 | 1/4" | 7,18 |
| BWH10 | 10 | 120 x 70 | 1/4" | 8,03 |
| BWH11 | 11 | 150 x 80 | 1/4" | 10,01 |
| BWH12 | 12 | 150 x 80 | 1/4" | 11,31 |
| BWH13 | 13 | 150 x 80 | 1/4" | 13,90 |
| BWH14 | 14 | 150 x 80 | 1/4" | 16,19 |

| | Ø mm | L1 x L2 mm |  | BMH € |
|-------|---------|---------------|---|----------|
| BMH03 | 3 | 59 x 35 | 1/4" | 2,15 |
| BMH04 | 4 | 74 x 41 | 1/4" | 2,28 |
| BMH05 | 5 | 82 x 55 | 1/4" | 2,26 |
| BMH06 | 6 | 88 x 58 | 1/4" | 3,03 |
| BMH07 | 7 | 110 x 70 | 1/4" | 3,44 |
| BMH08 | 8 | 110 x 70 | 1/4" | 3,58 |
| BMH09 | 9 | 110 x 70 | 1/4" | 3,73 |
| BMH10 | 10 | 115 x 75 | 1/4" | 4,14 |
| BMH11 | 11 | 135 x 85 | 1/4" | 4,83 |
| BMH12 | 12 | 135 x 85 | 1/4" | 5,65 |
| BMH13 | 13 | 135 x 90 | 1/4" | 8,85 |
| BMH14 | 14 | 145 x 95 | 1/4" | 11,03 |



| REFERENZA | BWH9318 | BWH9327 | BWH9319 | BMH9335 | BMH9333 |
|------------|------------------------|-------------------------|-------------------------------------|------------------------|-------------------------------------|
| N° PUNTE | 5 | 5 | 8 | 5 | 8 |
| APLICACIÓN | MURO | MURO | MURO | LEGNO | LEGNO |
| CONTENUTO | Ø 3 - 4 - 5 - 6 - 8 mm | Ø 4 - 5 - 6 - 8 - 10 mm | Ø 3 - 4 - 5 - 6 - 7 - 8 - 9 - 10 mm | Ø 3 - 4 - 5 - 6 - 8 mm | Ø 3 - 4 - 5 - 6 - 7 - 8 - 9 - 10 mm |
| P.V.P. € | 28,58 | 34,48 | 39,47 | 17,73 | 23,38 |

ASSORTIMENTI DI UTENSILI A CODOLO ESAGONALE 1/4"





Ref. EB



Ref. EMBP

CONTENUTO

| |  HSS-G |  HSS-G |  |  | € |
|------|---|---|---|---|--------|
| EM | M3 - M4 - M5 - M6 M8 - M10 | - | - | - | 62,66 |
| EMBP | M3 - M4 - M5 - M6 M8 - M10 | Ø 2,50 - 3,30 - 4,20 5 - 6,80 - 8,50 | - | - | 101,30 |
| EBM | - | - | M3 - M4 - M5 - M6 M8 - M10 | - | 132,69 |
| EA | - | - | - | Ø 6,30 - 8,30 - 10,40 12,40 - 16,50 - 20,50 | 127,97 |
| EB | - | Ø 1 - 10 mm x 0,50 | - | - | 140,34 |