



BLUE-MASTER[®]
by *ce/esa*



BITS PARA
PARAFUSOS

BITS INTERCAMBIÁVEIS



PHILLIPS



€ x Bit 2 Uds 5 Uds 50 Uds 100 Uds

	L1 mm		€		€		€		€
Ph 0	25	Ph0-2	1,55	Ph0-5	1,36	Ph0-50	1,21	Ph0-100	1,16
Ph 1	25	Ph1-2	1,30	Ph1-5	0,81	Ph1-50	0,73	Ph1-100	0,68
Ph 2	25	Ph2-2	1,30	Ph2-5	0,81	Ph2-50	0,73	Ph2-100	0,68
Ph 3	25	Ph3-2	1,30	Ph3-5	0,81	Ph3-50	0,73	Ph3-100	0,68

POZIDRIV



€ x Bit 2 Uds 5 Uds 50 Uds 100 Uds

	L1 mm		€		€		€		€
Pz 0	25	Pz0-2	1,55	Pz0-5	1,36	Pz0-50	1,21	Pz0-100	1,16
Pz 1	25	Pz1-2	1,30	Pz1-5	0,81	Pz1-50	0,73	Pz1-100	0,68
Pz 2	25	Pz2-2	1,30	Pz2-5	0,81	Pz2-50	0,73	Pz2-100	0,68
Pz 3	25	Pz3-2	1,30	Pz3-5	0,81	Pz3-50	0,73	Pz3-100	0,68

FENDA



€ x Bit 2 Uds 5 Uds 50 Uds 100 Uds

	L1 mm		€		€		€		€
0,5X3,0	25	P0,5X3,0-2	1,76	P0,5X3,0-5	1,52	P0,5X3,0-50	1,38	P0,5X3,0-100	1,31
0,6X3,5	25	P0,6X3,5-2	1,76	P0,6X3,5-5	1,52	P0,6X3,5-50	1,38	P0,6X3,5-100	1,31
0,5X4,0	25	P0,5X4,0-2	1,76	P0,5X4,0-5	1,52	P0,5X4,0-50	1,38	P0,5X4,0-100	1,31
0,6X4,5	25	P0,6X4,5-2	1,76	P0,6X4,5-5	1,52	P0,6X4,5-50	1,38	P0,6X4,5-100	1,31
0,8X4,0	25	P0,8X4,0-2	1,76	P0,8X4,0-5	1,52	P0,8X4,0-50	1,38	P0,8X4,0-100	1,31
0,8X5,0	25	P0,8X5,0-2	1,76	P0,8X5,0-5	1,52	P0,8X5,0-50	1,38	P0,8X5,0-100	1,31
0,8X5,5	25	P0,8X5,5-2	1,76	P0,8X5,5-5	1,52	P0,8X5,5-50	1,38	P0,8X5,5-100	1,31
1,0X5,5	25	P1X5,5-2	1,76	P1X5,5-5	1,52	P1X5,5-50	1,38	P1X5,5-100	1,31
1,0X6,0	25	P1X6,0-2	1,76	P1X6,0-5	1,52	P1X6,0-50	1,38	P1X6,0-100	1,31
1,2X6,5	25	P1,2X6,5-2	1,76	P1,2X6,5-5	1,52	P1,2X6,5-50	1,38	P1,2X6,5-100	1,31
1,2X8,0	25	P1,2X8,0-2	1,76	P1,2X8,0-5	1,52	P1,2X8,0-50	1,38	P1,2X8,0-100	1,31

BITS INTERCAMBIÁVEIS



25mm
COMPR.
TOTAL
(L.)



Bits para Parafusos
Rosa

TORX



€ x Bit		2 Uds		5 Uds		50 Uds		100 Uds	
	L1 mm		€		€		€		€
T5	25	PT5-2	2,32	PT5-5	2,01	PT5-50	1,82	PT5-100	1,72
T6	25	PT6-2	2,32	PT6-5	2,01	PT6-50	1,82	PT6-100	1,72
T7	25	PT7-2	2,32	PT7-5	2,01	PT7-50	1,82	PT7-100	1,72
T8	25	PT8-2	2,32	PT8-5	2,01	PT8-50	1,82	PT8-100	1,72
T9	25	PT9-2	2,32	PT9-5	2,01	PT9-50	1,82	PT9-100	1,72
T10	25	PT10-2	1,91	PT10-5	1,49	PT10-50	1,33	PT10-100	1,26
T15	25	PT15-2	1,91	PT15-5	1,49	PT15-50	1,33	PT15-100	1,26
T20	25	PT20-2	1,91	PT20-5	1,49	PT20-50	1,33	PT20-100	1,26
T25	25	PT25-2	1,91	PT25-5	1,49	PT25-50	1,33	PT25-100	1,26
T27	25	PT27-2	1,91	PT27-5	1,49	PT27-50	1,33	PT27-100	1,26
T30	25	PT30-2	1,91	PT30-5	1,49	PT30-50	1,33	PT30-100	1,26
T40	25	PT40-2	1,91	PT40-5	1,49	PT40-50	1,33	PT40-100	1,26

TORX
REDONDA



€ x Bit		2 Uds		5 Uds		50 Uds		100 Uds	
	L1 mm		€		€		€		€
TR10	25	PTR10-2	6,17	PTR10-5	5,36	PTR10-50	4,84	PTR10-100	4,55
TR15	25	PTR15-2	6,17	PTR15-5	5,36	PTR15-50	4,84	PTR15-100	4,55
TR20	25	PTR20-2	6,17	PTR20-5	5,36	PTR20-50	4,84	PTR20-100	4,55
TR25	25	PTR25-2	6,17	PTR25-5	5,36	PTR25-50	4,84	PTR25-100	4,55
TR30	25	PTR30-2	6,17	PTR30-5	5,36	PTR30-50	4,84	PTR30-100	4,55
TR40	25	PTR40-2	6,17	PTR40-5	5,36	PTR40-50	4,84	PTR40-100	4,55

QUADRADO
ROBERTSON



€ x Bit		2 Uds		5 Uds		50 Uds		100 Uds	
	L1 mm		€		€		€		€
Nº1	25	PC1-2	2,48	PC1-5	2,17	PC1-50	1,95	PC1-100	1,84
Nº2	25	PC2-2	2,48	PC2-5	2,17	PC2-50	1,95	PC2-100	1,84
Nº3	25	PC3-2	2,48	PC3-5	2,17	PC3-50	1,95	PC3-100	1,84

BITS INTERCAMBIÁVEIS

TORX DE
SEGURANÇA

€ x Bit	L1 mm	2 Uds		5 Uds		50 Uds		100 Uds	
			€		€		€		€
TS10	25	PTS10-2	3,31	PTS10-5	2,87	PTS10-50	2,59	PTS10-100	2,44
TS15	25	PTS15-2	3,31	PTS15-5	2,87	PTS15-50	2,59	PTS15-100	2,44
TS20	25	PTS20-2	3,31	PTS20-5	2,87	PTS20-50	2,59	PTS20-100	2,44
TS25	25	PTS25-2	3,31	PTS25-5	2,87	PTS25-50	2,59	PTS25-100	2,44
TS27	25	PTS27-2	3,31	PTS27-5	2,87	PTS27-50	2,59	PTS27-100	2,44
TS30	25	PTS30-2	3,31	PTS30-5	2,87	PTS30-50	2,59	PTS30-100	2,44
TS40	25	PTS40-2	3,31	PTS40-5	2,87	PTS40-50	2,59	PTS40-100	2,44

CABEÇA
SEXTAVADA

€ x Bit	L1 mm	2 Uds		5 Uds		50 Uds		100 Uds	
			€		€		€		€
2 mm	25	PHX2-2	1,83	PHX2-5	1,66	PHX2-50	1,48	PHX2-100	1,42
2,5 mm	25	PHX2,5-2	1,83	PHX2,5-5	1,66	PHX2,5-50	1,48	PHX2,5-100	1,42
3 mm	25	PHX3-2	1,83	PHX3-5	1,66	PHX3-50	1,48	PHX3-100	1,42
4 mm	25	PHX4-2	1,83	PHX4-5	1,66	PHX4-50	1,48	PHX4-100	1,42
5 mm	25	PHX5-2	1,83	PHX5-5	1,66	PHX5-50	1,48	PHX5-100	1,42
6 mm	25	PHX6-2	1,83	PHX6-5	1,66	PHX6-50	1,48	PHX6-100	1,42
8 mm	25	PHX8-2	2,17	PHX8-5	1,97	PHX8-50	1,90	PHX8-100	1,79

TRI
WING

€ x Bit	L1 mm	2 Uds		5 Uds		50 Uds		100 Uds	
			€		€		€		€
Nº4	25	PTRW4-2	10,92	PTRW4-5	9,50	PTRW4-50	8,55	PTRW4-100	8,08
Nº5	25	PTRW5-2	10,92	PTRW5-5	9,50	PTRW5-50	8,55	PTRW5-100	8,08
Nº6	25	PTRW6-2	10,92	PTRW6-5	9,50	PTRW6-50	8,55	PTRW6-100	8,08
Nº8	25	PTRW8-2	10,92	PTRW8-5	9,50	PTRW8-50	8,55	PTRW8-100	8,08

XZN



€ x Bit	L1 mm	2 Uds		5 Uds		50 Uds		100 Uds	
			€		€		€		€
Nº4	25	PXZN4-2	6,69	PXZN4-5	5,83	PXZN4-50	5,24	PXZN4-100	4,95
Nº5	25	PXZN5-2	6,69	PXZN5-5	5,83	PXZN5-50	5,24	PXZN5-100	4,95
Nº6	25	PXZN6-2	6,69	PXZN6-5	5,83	PXZN6-50	5,24	PXZN6-100	4,95
Nº8	25	PXZN8-2	7,51	PXZN8-5	6,53	PXZN8-50	6,41	PXZN8-100	6,29
Nº10	25	PXZN10-2	7,51	PXZN10-5	6,53	PXZN10-50	6,41	PXZN10-100	6,29

BITS INTERCAMBIÁVEIS



50mm
COMPR. TOTAL (L)



Bits para Parafusos
Rosa

PHILLIPS



€ x Bit		2 Uds		5 Uds		50 Uds	
	L1 mm		€		€		€
Ph 1	50	Ph1X50-2	2,97	Ph1X50-5	2,59	Ph1X50-50	2,33
Ph 2	50	Ph2X50-2	2,97	Ph2X50-5	2,59	Ph2X50-50	2,33
Ph 3	50	Ph3X50-2	2,97	Ph3X50-5	2,59	Ph3X50-50	2,33
Ph 4	50	Ph4X50-2	-	Ph4X50-5	-	Ph4X50-50	-

POZIDRIV



€ x Bit		2 Uds		5 Uds		50 Uds	
	L1 mm		€		€		€
Pz 1	50	Pz1X50-2	2,97	Pz1X50-5	2,59	Pz1X50-50	2,33
Pz 2	50	Pz2X50-2	2,97	Pz2X50-5	2,59	Pz2X50-50	2,33
Pz 3	50	Pz3X50-2	2,97	Pz3X50-5	2,59	Pz3X50-50	2,33
Pz 4	50	Pz4X50-2	-	Pz4X50-5	-	Pz4X50-50	-

FENDA



€ x Bit		2 Uds		5 Uds		50 Uds	
	L1 mm		€		€		€
0,5X4,0	50	P0,5X4,0X50-2	4,69	P0,5X4,0X50-5	4,06	P0,5X4,0X50-50	3,64
0,5X3,0	50	P0,5X3,0X50-2	4,69	P0,5X3,0X50-5	4,06	P0,5X3,0X50-50	3,64
0,6X3,5	50	P0,6X3,5X50-2	4,69	P0,6X3,5X50-5	4,06	P0,6X3,5X50-50	3,64
0,6X4,5	50	P0,6X4,5X50-2	4,69	P0,6X4,5X50-5	4,06	P0,6X4,5X50-50	3,64
0,8X4,0	50	P0,8X4,0X50-2	4,69	P0,8X4,0X50-5	4,06	P0,8X4,0X50-50	3,64
0,8X5,0	50	P0,8X5,0X50-2	4,69*	P0,8X5,0X50-5	4,06*	P0,8X5,0X50-50	3,64*
0,8X5,5	50	P0,8X5,5X50-2	4,69	P0,8X5,5X50-5	4,06	P0,8X5,5X50-50	3,64
1,0X5,5	50	P1X5,5X50-2	4,69	P1X5,5X50-5	4,06	P1X5,5X50-50	3,64
1,0X6,0	50	P1X6,0X50-2	4,69	P1X6,0X50-5	4,06	P1X6,0X50-50	3,64
1,2X6,5	50	P1,2X6,5X50-2	4,69	P1,2X6,5X50-5	4,06	P1,2X6,5X50-50	3,64
1,2X8,0	50	P1,2X8,0X50-2	4,69	P1,2X8,0X50-5	4,06	P1,2X8,0X50-50	3,64

*Até o fim das existências

BITS INTERCAMBIÁVEIS



TORX



€ x Bit	2 Uds		5 Uds		50 Uds		
	L1 mm	€	€	€	€		
T 5	50	PT5X50-2	6,00	PT5X50-5	4,57	PT5X50-50	4,23
T 6	50	PT6X50-2	6,00	PT6X50-5	4,57	PT6X50-50	4,23
T 7	50	PT7X50-2	6,00	PT7X50-5	4,57	PT7X50-50	4,23
T 8	50	PT8X50-2	6,00	PT8X50-5	4,57	PT8X50-50	4,23
T 9	50	PT9X50-2	6,00	PT9X50-5	4,57	PT9X50-50	4,23
T 10	50	PT10X50-2	5,52	PT10X50-5	4,30	PT10X50-50	3,87
T 15	50	PT15X50-2	5,52	PT15X50-5	4,30	PT15X50-50	3,87
T 20	50	PT20X50-2	5,52	PT20X50-5	4,30	PT20X50-50	3,87
T 25	50	PT25X50-2	5,52	PT25X50-5	4,30	PT25X50-50	3,87
T 27	50	PT27X50-2	5,52	PT27X50-5	4,30	PT27X50-50	3,87
T 30	50	PT30X50-2	5,52	PT30X50-5	4,30	PT30X50-50	3,87
T 40	50	PT40X50-2	5,52	PT40X50-5	4,30	PT40X50-50	3,87

QUADRADO
ROBERTSON

€ x Bit	2 Uds		5 Uds		50 Uds		
	L1 mm	€	€	€	€		
Nº1	50	PC1X50-2	7,20	PC1X50-5	6,26	PC1X50-50	5,64
Nº2	50	PC2X50-2	7,20	PC2X50-5	6,26	PC2X50-50	5,64
Nº3	50	PC3X50-2	7,20	PC3X50-5	6,26	PC3X50-50	5,64

SEXTAVADA



€ x Bit	2 Uds		5 Uds		50 Uds		
	L1 mm	€	€	€	€		
2 mm	50	PHX2X50-2	5,83	PHX2X50-5	5,07	PHX2X50-50	4,56
2,5 mm	50	PHX2,5X50-2	5,83	PHX2,5X50-5	5,07	PHX2,5X50-50	4,56
3 mm	50	PHX3X50-2	5,83	PHX3X50-5	5,07	PHX3X50-50	4,56
4 mm	50	PHX4X50-2	5,83	PHX4X50-5	5,07	PHX4X50-50	4,56
5 mm	50	PHX5X50-2	5,83	PHX5X50-5	5,07	PHX5X50-50	4,56
6 mm	50	PHX6X50-2	5,83	PHX6X50-5	5,07	PHX6X50-50	4,56
8 mm	50	PHX8X50-2	7,47	PHX8X50-5	6,84	PHX8X50-50	5,85

BITS INTERCAMBIÁVEIS



70mm
COMPR.
TOTAL
(L.)



PHILLIPS



€ x Bit

2 Uds

5 Uds

	L1 mm		€		€
Ph 1	70	Ph1X70-2	6,97	Ph1X70-5	6,07
Ph 2	70	Ph2X70-2	6,97	Ph2X70-5	6,07
Ph 3	70	Ph3X70-2	6,97	Ph3X70-5	6,07
Ph 4	70	Ph4X70-2	-	Ph4X70-5	-

POZIDRIV



€ x Bit

2 Uds

5 Uds

	L1 mm		€		€
Pz 1	70	Pz1X70-2	7,04	Pz1X70-5	6,12
Pz 2	70	Pz2X70-2	7,04	Pz2X70-5	6,12
Pz 3	70	Pz3X70-2	7,04	Pz3X70-5	6,12
Pz 4	70	Pz4X70-2	-	Pz4X70-5	-



90mm
COMPR.
TOTAL
(L.)



PHILLIPS



€ x Bit

2 Uds

5 Uds

	L1 mm		€		€
Ph 1	90	Ph1X90-2	8,59	Ph1X90-5	7,48
Ph 2	90	Ph2X90-2	8,59	Ph2X90-5	7,48
Ph 3	90	Ph3X90-2	8,59	Ph3X90-5	7,48
Ph 4	90	Ph4X90-2	-	Ph4X90-5	-

POZIDRIV



€ x Bit

2 Uds

5 Uds

	L1 mm		€		€
Pz 1	90	Pz1X90-2	8,67	Pz1X90-5	7,55
Pz 2	90	Pz2X90-2	8,67	Pz2X90-5	7,55
Pz 3	90	Pz3X90-2	8,67	Pz3X90-5	7,55
Pz 4	90	Pz4X90-2	-	Pz4X90-5	-

BITS INTERCAMBIÁVEIS

TiN

25mm
COMPR.
TOTAL
(L)

PHILLIPS



€ x Bit		2 Uds		5 Uds		50 Uds	
	L1 mm		€		€		€
Ph 1	25	Ph1T-2	3,51	Ph1T-5	2,65	Ph1T-50	2,38
Ph 2	25	Ph2T-2	3,51	Ph2T-5	2,65	Ph2T-50	2,38
Ph 3	25	Ph3T-2	3,51	Ph3T-5	2,65	Ph3T-50	2,38

POZIDRIV



€ x Bit		2 Uds		5 Uds		50 Uds	
	L1 mm		€		€		€
Pz 1	25	Pz1T-2	3,54	Pz1T-5	2,67	Pz1T-50	2,41
Pz 2	25	Pz2T-2	3,54	Pz2T-5	2,67	Pz2T-50	2,41
Pz 3	25	Pz3T-2	3,54	Pz3T-5	2,67	Pz3T-50	2,41

FENDA



€ x Bit		2 Uds		5 Uds		50 Uds	
	L1 mm		€		€		€
0,6X4,5	25	P0,6X4,5T-2	3,80	P0,6X4,5T-5	3,29	P0,6X4,5T-50	2,96
0,8X5,5	25	P0,8X5,5T-2	3,80	P0,8X5,5T-5	3,29	P0,8X5,5T-50	2,96
1,0X5,5	25	P1X5,5T-2	3,80	P1X5,5T-5	3,29	P1X5,5T-50	2,96
1,2X6,5	25	P1,2X6,5T-2	3,80	P1,2X6,5T-5	3,29	P1,2X6,5T-50	2,96

TORX



€ x Bit		2 Uds		5 Uds		50 Uds	
	L1 mm		€		€		€
T 10	25	PT10T-2	3,65	PT10T-5	3,28	PT10T-50	2,87
T 15	25	PT15T-2	3,65	PT15T-5	3,28	PT15T-50	2,87
T 20	25	PT20T-2	3,65	PT20T-5	3,28	PT20T-50	2,87
T 25	25	PT25T-2	3,65	PT25T-5	3,28	PT25T-50	2,87
T 27	25	PT27T-2	3,65	PT27T-5	3,28	PT27T-50	2,87
T 30	25	PT30T-2	3,65	PT30T-5	3,28	PT30T-50	2,87
T 40	25	PT40T-2	3,65	PT40T-5	3,28	PT40T-50	2,87

BITS INTERCAMBIÁVEIS

TiN



50mm
COMPR. TOTAL
(L)



PHILLIPS



€ x Bit	2 Uds		5 Uds		50 Uds		
	L1 mm		€	€	€	€	
Ph 1	50	Ph1Tx50-2	8,09	Ph1Tx50-5	7,03	Ph1Tx50-50	6,31
Ph 2	50	Ph2Tx50-2	8,09	Ph2Tx50-5	7,03	Ph2Tx50-50	6,31
Ph 3	50	Ph3Tx50-2	8,09	Ph3Tx50-5	7,03	Ph3Tx50-50	6,31

POZIDRIV



€ x Bit	2 Uds		5 Uds		50 Uds		
	L1 mm		€	€	€	€	
Pz 1	50	Pz1Tx50-2	8,17	Pz1Tx50-5	7,10	Pz1Tx50-50	6,37
Pz 2	50	Pz2Tx50-2	8,17	Pz2Tx50-5	7,10	Pz2Tx50-50	6,37
Pz 3	50	Pz3Tx50-2	8,17	Pz3Tx50-5	7,10	Pz3Tx50-50	6,37

TORX



€ x Bit	2 Uds		5 Uds		50 Uds		
	L1 mm		€	€	€	€	
T 10	50	PT10Tx50-2	11,57	PT10Tx50-5	10,06	PT10Tx50-50	9,05
T 15	50	PT15Tx50-2	11,57	PT15Tx50-5	10,06	PT15Tx50-50	9,05
T 20	50	PT20Tx50-2	11,57	PT20Tx50-5	10,06	PT20Tx50-50	9,05
T 25	50	PT25Tx50-2	11,57	PT25Tx50-5	10,06	PT25Tx50-50	9,05
T 27	50	PT27Tx50-2	11,57	PT27Tx50-5	10,06	PT27Tx50-50	9,05
T 30	50	PT30Tx50-2	11,57	PT30Tx50-5	10,06	PT30Tx50-50	9,05
T 40	50	PT40Tx50-2	11,57	PT40Tx50-5	10,06	PT40Tx50-50	9,05

PORTA-BITS MÁGNETICOS

PORTA-BITS MÁGNETICOS

	L1 mm	TIPO DE CABO	€
PMGx51	51	MAGNÉTICO SEM ANEL	6,99
PMGx58	58	MAGNÉTICO SEM ANEL	7,26
PMGx74	74	MAGNÉTICO COM ANEL	11,97
PMGx100	100	MAGNÉTICO COM ANEL	14,48
PMGx150	150	MAGNÉTICO COM ANEL	16,13
PMGx200	200	MAGNÉTICO COM ANEL	19,09
PMGx250	250	MAGNÉTICO COM ANEL	29,36
PMGSDSx78	78	SDS PLUS	20,03
PBERx74	74	BERILIO	51,40*
PDESSx70	70	5/16" DESSOUTTER	31,67*
P7x74	74	7mm Fein	34,40*

*Ate o fim das existencias



Ref. PMGSDSX78

Ref. PMGX74

Ref. PMGX100

PORTA-BITS MAGNÉTICO COM MUDANÇA RÁPIDA APTO PARA BITS DE 1/4" COM COLARINHO

	L1 mm	TIPO DE CABO	€
PCR60	60	Mudança rápida 1/4" Apto para bits de 1/4" com colarinho	17,81
PCR74	74	Mudança rápida 1/4" Apto para bits de 1/4" com colarinho	18,34
PCRSDSX80	80	SDS PLUS	29,21



Ref. PCRSDSX80

Ref. PCR60

PORTA-BITS MAGNÉTICO COM ANEL MAGNÉTICO FRONTAL PARA SUJEÇÃO DE PARAFUSOS

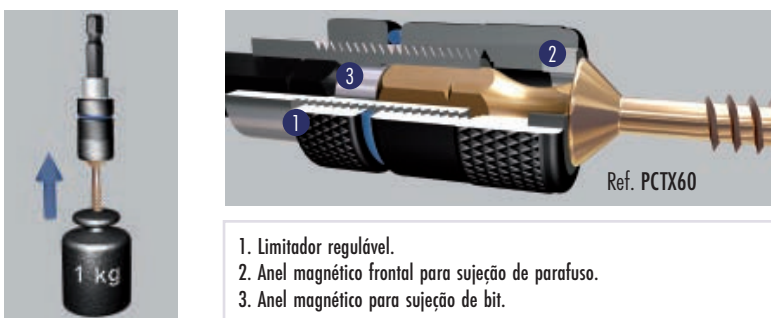

1. Limitador regulável.
2. Anel magnético frontal para sujeção de parafuso.
3. Anel magnético para sujeção de bit.

	L1 mm	TIPO DE CABO	€
PCTX60	60	Porta-bits com limitador regulável	16,77



Ref. PCTX60

CHAVES DE CAIXA MAGNÉTICAS SEXTAVADAS



SEXTAVADA MÁGNÉTICA



	mm	"		€/ 1U.
PLHX5-2	5,0		2	6,35
PLHX5,5-2	5,5		2	6,35
PLHX6-2	6,0		2	6,35
PLHX1/4-2		1/4"=6,35	2	6,35
PLHX7-2	7,0		2	6,49
PLHX5/16-2		5/16"=7,93	2	6,49
PLHX8-2	8,0		2	6,49
PLHX3/8-2		3/8"=9,52	2	6,49
PLHX10-2	10,0		2	6,65
PLHX11-2	11,0		2	6,84
PLHX12-2	12,0		2	6,90
PLHX13-2	13,0		2	7,23

ESTOJOS DE 7 PEÇAS DE CHAVES DE CAIXA MAGNÉTICAS SEXTAVADAS

REFERÊNCIA	EPLL
Nº CHAVES	7
CONTEÚDO	HX1/4 - HX7 - HX8 - HX3/8 HX10 - HX12 - HX13
P.V.P. €	47,09



CHAVE DE BITS COM ROQUETE + ARMAZÉM DE BITS E EXPOSITOR PARA CHAVES

Plus

1. Alta qualidade e rendimento.
2. Giro a direitas e esquerdas.
3. Cabo telescópico ajustável em comprimento.
4. Feito em aço e plástico de alta resistência.

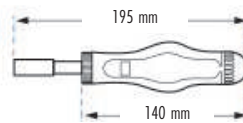

DTRC

- Conteúdo da chave:
- PH1 - PH2
 - PZ1 - PZ2
 - T15 - T20 - T25 - T30

35,77 €

ESTOJOS DE BITS INTERCAMBIÁVEIS

ESTOJOS DE 7 PEÇAS QUALIDADE PLUS E TIN



Ref. EPT1

REFERÊNCIA	EPT1	EPT2	EPT3
Nº PEÇAS	7	7	7
CONTEÚDO	<ul style="list-style-type: none"> PH1 - PH2 PZ1 - PZ2 0,8x5,5 - 1,2x6,5 1 Porta-bits PMG	<ul style="list-style-type: none"> T10 - T15 T20 - T25 T30 - T40 1 Porta-bits PMG	<ul style="list-style-type: none"> PH1 - PH2 - PH3 PZ1 - PZ2 - PZ3 1 Porta-bits PMG
P.V.P. €	12,45	16,78	14,92







Ref. EPTT1



REFERÊNCIA	EPTT1	EPTT2	EPTT3
Nº PEÇAS	7	7	7
CONTEÚDO	<ul style="list-style-type: none"> PH1 - PH2 PZ1 - PZ2 0,8x5,5 - 1,2x6,5 1 Porta-bits PMG	<ul style="list-style-type: none"> T10 - T15 T20 - T25 T30 - T40 1 Porta-bits PMG	<ul style="list-style-type: none"> PH1 - PH2 - PH3 PZ1 - PZ2 - PZ3 1 Porta-bits PMG
P.V.P. €	35,31	40,95	34,04

ESTOJOS DE BITS INTERCAMBIÁVEIS





ESTOJOS DE 12 PEÇAS QUALIDADE PLUS E TIN

Ref. EPT4		REFERÊNCIA	EPT4		EPT5	
		Nº PEÇAS	12		12	
		CONTEÚDO	<ul style="list-style-type: none"> ⊕ PH1 - PH2(2) - PH3 ⊕ PZ1 - PZ2(2) - PZ3 ⊖ 0,6x4,5 - 0,8x5,5 - 1,2x6,5 1 Porta-bits PMG		<ul style="list-style-type: none"> T10 - T15(2) ★ T20(2) - T25(2) T27 - T30(2) - T40 1 Porta-bits PMG	
			16,70		22,93	
Ref. EPTT4		REFERÊNCIA	EPTT4		EPTT5	
		Nº PEÇAS	12		12	
		CONTEÚDO	<ul style="list-style-type: none"> ⊕ PH1 - PH2(2) - PH3 ⊕ PZ1 - PZ2(2) - PZ3 ⊖ 0,6x4,5 - 0,8x5,5 - 1,2x6,5 1 Porta-bits PCT		<ul style="list-style-type: none"> T10 - T15(2) ★ T20(2) - T25(2) T27 - T30(2) - T40 1 Porta-bits PCT	
			44,47		52,31	

ESTOJOS DE 31 PEÇAS QUALIDADE PLUS E TiN

Ref. EPT6		REFERÊNCIA	EPT6			
		Nº PEÇAS	31			
		CONTEÚDO	<ul style="list-style-type: none"> ⊕ PH1(3) - PH2(3) - PH3(3) ⊕ PZ1(3) - PZ2(3) - PZ3(3) ⊖ 0,6x4,5 - 0,8x5,5 - 1,2x6,5 1 Porta-bits PMG		<ul style="list-style-type: none"> ★ T10 - T15 - T20 - T25 - T30 - T40 ○ H3 - H4 - H5 1 Porta-bits PMG	
			47,72			
		REFERÊNCIA	EPTT6			
		Nº PEÇAS	31			
		CONTEÚDO	<ul style="list-style-type: none"> ⊕ PH1(3) - PH2(3) - PH3(3) ⊕ PZ1(3) - PZ2(3) - PZ3(3) ⊖ 0,6x4,5 - 0,8x5,5 - 1,2x6,5 1 Porta-bits PCT		<ul style="list-style-type: none"> ★ T10 - T15 - T20 - T25 - T30 - T40 ○ H3 - H4 - H5 1 Porta-bits PCT	
			101,25			

ESTOJOS DE 36 PEÇAS QUALIDADE PLUS E TiN

Ref. EPT7		REFERÊNCIA	EPT7			
		Nº PEÇAS	36			
		CONTEÚDO	<ul style="list-style-type: none"> ⊕ PH1(3) - PH2(3) - PH3(3) ⊕ PZ1(3) - PZ2(3) - PZ3(3) ⊖ 0,5 x 4 - 0,6 x 4,5 - 0,8 x 5 - 0,8 x 5,5 - 1 x 6 - 1,2 x 6,5 - 1,2 x 8 1 Porta-bits PMG		<ul style="list-style-type: none"> ★ T10 - T15 - T20 - T25 - T27 - T30 - T40 ○ H2 - H2,5 - H3 - H4 - H5 - H6 - H8 1 Porta-bits PMG	
			60,43			
Ref. EPTT7		REFERÊNCIA	EPTT7*			
		Nº PEÇAS	36			
		CONTEÚDO	<ul style="list-style-type: none"> ⊕ PH1(3) - PH2(3) - PH3(3) ⊕ PZ1(3) - PZ2(3) - PZ3(3) ⊖ 0,5 x 4 - 0,6 x 4,5 - 0,8 x 5 - 0,8 x 5,5 - 1 x 6 - 1,2 x 6,5 - 1,2 x 8 1 Porta-bits PCT		<ul style="list-style-type: none"> ★ T10 - T15 - T20 - T25 - T27 - T30 - T40 ○ H2 - H2,5 - H3 - H4 - H5 - H6 - H8 1 Porta-bits PCT	
			123,99*			

*Ate o fim das existencias

ESTOJOS DE BITS INTERCAMBIÁVEIS

ESTOJOS DE 45 E 80 PEÇAS QUALIDADE *Plus*

Bits para Parafusos

Rosa



Ref. EPT45



Ref. EPT80

REFERÊNCIA	EPT45	
Nº PEÇAS	45	
CONTEÚDO	<ul style="list-style-type: none"> PH1(2) - PH2(2) - PH3(2) PZ1(2) - PZ2(2) - PZ3(2) 0,5x3-0,6x4,5-0,8x5,5(2)-1,2x6,5-1,6x8 H2,5 - H3 - H4 - H5 - H6 - H7 T10 - T15 - T20 - T25 - T30 - T40 	<ul style="list-style-type: none"> Chaves de caixa sextavadas (mm): 5 - 6 - 7 - 8 - 9 - 10 - 11 - 12 - 13 - 14 1 Adaptador para chaves de caixa 1 Adaptador para bits 1 Porta-bits magnético PCR 1 Chave de roquete de 72 dentes 1 Chave de parafusos
P.V.P. €	151,21	

REFERÊNCIA	EPT80*	
Nº PEÇAS	80	
CONTEÚDO	<ul style="list-style-type: none"> PH0 - PH1 - PH2(4) - PH3(2) PZ1 - PZ2(4) - PZ3(2) 0,5x3-0,6x4,5-0,8x5,5(2)-1,2x6,5-1,6x8 H2 - H2,5 - H3 - H4 - H5 - H6 - H7 - H8 TW1 - TW2 - TW3 - TW4 - TW5 TQ5 - TQ6 - TQ8 - TQ10 T5 - T6 - T7 - T8 - T9 - T10 - T15 T20(2) - T25(2) - T27 - T30 - T40 TS10 - TS15 - TS20 - TS25 - TS30 - TS40 	<ul style="list-style-type: none"> C0 - C1 - C2 - C3 SP4 - SP6 - SP8 - SP10 HS3 - HS4 - HS5 - HS6 1 Porta-bits magnético PCR 1 Chave de parafusos
P.V.P. €	155,24*	

*Ate o fim das existencias

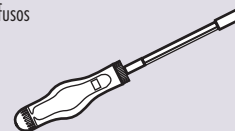

EXTRATORES DE MÁQUINAS PARA PARAFUSOS QUEBRADOS

MICRO GRABIT

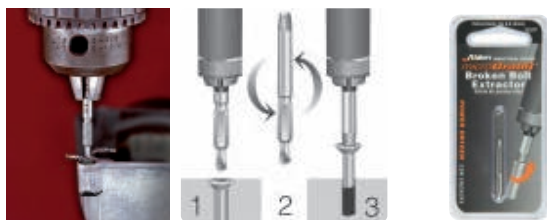

		EP
		€
EP451C	M3	55,10
EP452C	M4	55,10
EP453C	M5	55,10
EP454C	M6	55,10

1. Furar no parafuso.
2. Dar a volta.
3. Extrair.

PRO GRABIT COM CORPO SEXTAVADO 1/4"

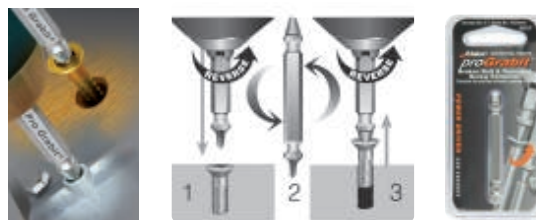

		EP
		€
EP8401C	M5	43,70
EP8402C	M6	51,63
EP8403C	M8	51,63
EP8404C	M10	54,18

1. Furar no parafuso.
2. Dar a volta.
3. Extrair.

DRILL OUT EXTRATOR DE PARAFUSOS QUEBRADOS COM BROCA GUIA (M6-M12)

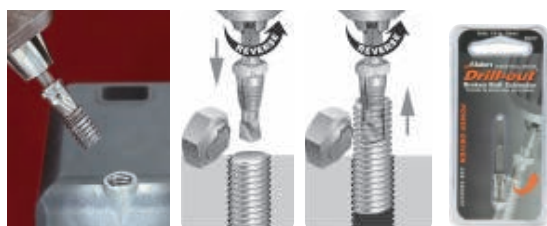

		EP
		€
EP205C	M6	53,42
EP312C	M8	64,73
EP375C	M10	64,73
EP500C	M12	72,86

X-OUT EXTRATOR DE PARAFUSOS QUEBRADOS COM CABO SEXTAVADO (M3-M5)



		EP
		€
EP3701C	M3	43,70
EP3702C	M4	43,70
EP3703C	M5	48,57

ESTOJOS DE EXTRATORES DE MÁQUINA PARA PARAFUSOS QUEBRADOS

MICRO GRABIT



REFERÊNCIA	EP450C
Nº PEÇAS	4
CONTEÚDO	M3-M4-M5-M6
P.V.P. €	226,00

DRILL-OUT



REFERÊNCIA	EP401C
Nº PEÇAS	4
CONTEÚDO	M6-M8-M10-M12
P.V.P. €	265,87

EXTRATORES LAMINADOS MANUAIS PARA PARAFUSOS QUEBRADOS

JOGOS DE EXTRATORES CLÁSSICOS DE PARAFUSOS

Fazer um furo no centro com a broca BLUE-MASTER recomendada, introduzir o extrator no furo, girar o extrator à esquerda até extrair o estrator.

REFERÊNCIA	EX/1-5	EX/1-6	EX/1-8
Nº PEÇAS	5	6	8
CONTEÚDO	M3 - M18	M3 - M24	M3 - M45
P.V.P. €	23,38	31,64	73,03



Ref. EX/1-6

Bits para Parafusos

Rosa



	Para PARAFUSOS	mm	mm	L1 mm	Ø min mm	Ø max. mm	EX €
EX/1	M3 - M6	3,2	2,5	51	1,75	3,95	2,90
EX/2	M6 - M8	4,0	3,0	60	2,20	4,80	2,90
EX/3	M8 - M11	5,1	4,5	68	3,30	6,40	3,44
EX/4	M11 - M14	6,2	6,0	76	4,75	8,40	4,26
EX/5	M14 - M18	8,6	8,0	86	6,35	11,00	5,54
EX/6	M18 - M24	12,0	11,0	95	9,50	15,00	9,38
EX/7	M24 - M33	15,9	14,0	105	12,70	19,00	25,40
EX/8	M33 - M45	20,0	21,0	111	19,00	25,00	41,61



REFERÊNCIA	EXTT
Nº PEÇAS	10
EXTRATORES	EX/1-EX/2-EX/3-EX/4-EX/5
BROCAS PREVIAS	Ref. BC3 Ø2,5-3-4-5-6-8
P.V.P. €	39,01

EXTRATORES MANUAIS FRESADOS PARA PARAFUSOS QUEBRADOS



	Para PARAFUSOS	mm	mm	L1 mm	Ø min mm	Ø max. mm	EFX €
EFX/1	M3-M6	2,9	2,0	50	1,9	3,2	3,69
EFX/2	M6-M8	3,9	3,2	60	2,8	5,0	3,69
EFX/3	M8-M11	4,8	4,0	68	3,2	6,5	4,35
EFX/4	M11-M14	6,7	6,4	75	5,2	9,0	5,40
EFX/5	M14-M18	8,5	7,1	85	6,4	11,0	7,00
EFX/6	M18-M25	11,8	9,5	95	9,4	15,0	11,88
EFX/7	M25-M35	14,3	12,7	106	12,8	19,0	32,16
EFX/8	M35-M45	19,5	19,5	110	19,3	25,0	52,67



Ref. EFX/1-5

REFERÊNCIA	EFX/1-5
Nº PEÇAS	5
CONTEÚDO	M3 - M18
P.V.P. €	28,16

BROCA PARA METAL DIN 338

Ref. BH2

HSS



OX



	Ø mm	L1 x L2 mm	mm	BH2 €
BH20200	2,00	61 x 33	1/4"	7,52
BH20300	3,00	61 x 33	1/4"	7,69
BH20400	4,00	75 x 43	1/4"	8,14
BH20500	5,00	86 x 52	1/4"	10,12
BH20600	6,00	93 x 57	1/4"	10,93
BH20700	7,00	109 x 69	1/4"	13,78
BH20800	8,00	117 x 75	1/4"	15,47
BH20900	9,00	125 x 81	1/4"	17,40
BH21000	10,00	133 x 87	1/4"	19,38



REFERÊNCIA	BH29335	BH29333
Nº BROCAS	5	8
QUALIDADE	HSS	HSS
CONTEÚDO	Ø 3-4-5-6-8 mm	Ø 3-4-5-6-7-8-9-10 mm
P.V.P. €	53,15	71,10

FERRAMENTAS COM CABO SEXTAVADO 1/4"

BROCA PARA METAL EXTRA-CURTA

HSS-G

Ref. BC59



BROCA-MACHO ESCAREADOR

HSS-G

Ref. MAHM

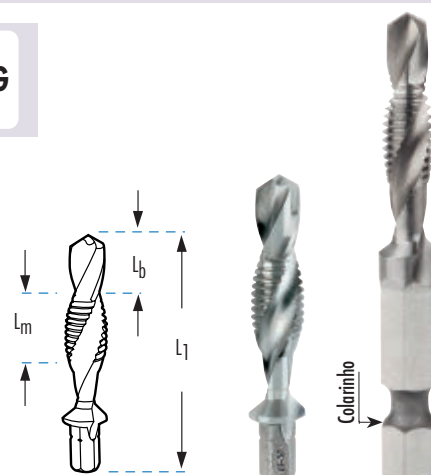

	Ø mm	L1 x L2 mm		BC59 €	BC59CR €
BC590100	1,00	34 x 12	1/4"	7,52	-
BC590150	1,50	34 x 12	1/4"	7,52	-
BC590200	2,00	34 x 12	1/4"	7,52	7,52
BC590250	2,50	36 x 14	1/4"	7,52	7,52
BC590300	3,00	38 x 16	1/4"	7,52	7,52
BC590330	3,30	40 x 18	1/4"	7,52	7,52
BC590350	3,50	40 x 18	1/4"	7,52	7,52
BC590400	4,00	44 x 20	1/4"	7,52	7,52
BC590420	4,20	45 x 20	1/4"	7,52	7,52
BC590450	4,50	46 x 24	1/4"	7,52	7,52
BC590500	5,00	50 x 26	1/4"	7,52	7,52
BC590550	5,50	50 x 26	1/4"	8,21	8,21
BC590600	6,00	50 x 26	1/4"	8,21	8,21
BC590650	6,50	50 x 30	1/4"	8,21	8,21
BC590680	6,80	50 x 30	1/4"	8,21	8,21
BC590700	7,00	50 x 30	1/4"	8,21	8,21
BC590750	7,50	51 x 32	1/4"	9,29	9,29
BC590800	8,00	51 x 32	1/4"	9,29	9,29
BC590850	8,50	53 x 33	1/4"	9,29	9,29
BC590900	9,00	53 x 33	1/4"	11,21	11,21
BC590950	9,50	54 x 38	1/4"	11,21	11,21
BC591000	10,00	54 x 38	1/4"	11,21	11,21
BC591020	10,20	54 x 38	1/4"	11,21	11,21

	L1 x Lb x Lm mm		MAHM €	MAHMCR €
M 3 x 0,50	36 x 5 x 6	1/4"	24,53	24,53
M 4 x 0,70	39 x 6 x 7	1/4"	24,53	24,53
M 5 x 0,80	41 x 8 x 8	1/4"	25,60	25,60
M 6 x 1,00	44 x 8 x 10	1/4"	26,66	26,66
M 8 x 1,25	50 x 10 x 11	1/4"	36,86	36,86
M 10 x 1,50	59 x 11 x 11	1/4"	44,47	44,47



REFERÊNCIA	MAH9327CR
Nº BROCAS	5
REFERÊNCIA BROCAS	MAHMCR
CONTEÚDO	M4-M5-M6-M8-M10
P.V.P. €	182,64

MACHO HSS-G

HSS-G

Ref. M

	L1 x L2 mm		M €	MCR €
M 3 x 0,50	33 x 11	1/4"	8,90	8,90
M 4 x 0,70	35 x 12	1/4"	8,90	8,90
M 5 x 0,80	36 x 15	1/4"	11,34	11,34
M 6 x 1,00	39 x 18	1/4"	11,34	11,34
M 8 x 1,25	40 x 19	1/4"	15,70	15,70
M 10 x 1,50	41 x 21	1/4"	19,39	19,39

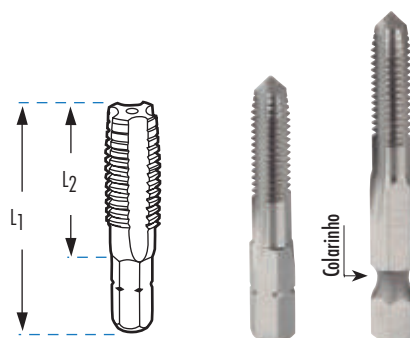

FERRAMENTAS COM CABO SEXTAVADO 1/4"

BROCA MACHO HSSCo STEP CUT

NEW

DIN 13

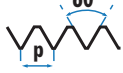

HSSCo
5%

BRILHANTE

TOL
6H

D
CABO
FINO

1/4"

Ref. MTKM

STEP CUT

										MTKM
		Lb	Lm	L3	L	Db	D2	D3		€
		mm	mm	mm	mm	mm	mm	mm	1/4"	
M	3x0,50	D 7,0	6,0	6,0	57,0	2,5	2,2	7,3	1/4"	28,21
M	4x0,70	D 7,0	8,5	6,0	62,0	3,3	3,0	7,3	1/4"	28,21
M	5x0,80	D 9,0	10,0	6,0	69,0	4,2	3,7	7,3	1/4"	29,44
M	6x1,00	D 10,0	12,0	6,0	73,0	5,0	4,5	7,3	1/4"	30,66
M	8x1,25	D 12,0	16,0	6,0	87,0	6,8	6,3	9,4	1/4"	42,38
M	10x1,50	D 14,0	20,0	6,0	96,0	8,5	8,0	11,4	1/4"	51,14
M	12x1,75	D 16,0	24,0	8,0	112,0	10,3	9,8	13,4	1/4"	56,36

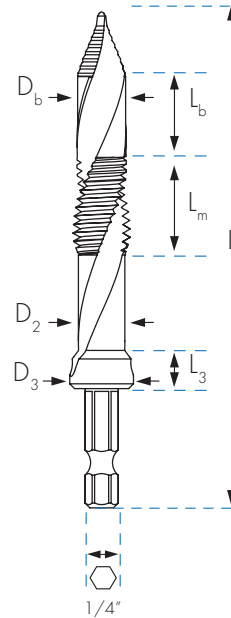

Bits para Parafusos

Rosa

ESCREADOR DE 3 CANAIS

HSS-G

Ref. AV22

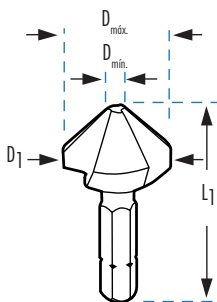

ESCREADOR PARA REBARBAR

HSS



1/4"

Ref. AV1...CR

Ref. AV101CR
Ref. AV102CR



Ref. AV103CR
Ref. AV104CR

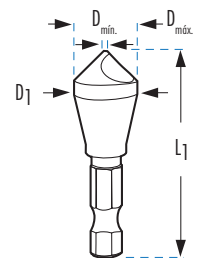

					AV22
D1	L1	D min. - D max.		€	
mm	mm	mm	1/4"		
6,30	31	1,50 - 5,8	1/4"	22,65	
8,30	31	2,00 - 7,8	1/4"	22,65	
10,40	34	2,50 - 10,0	1/4"	24,27	
12,40	35	2,80 - 12,0	1/4"	25,89	
16,50	40	3,20 - 16,0	1/4"	27,73	
20,50	41	3,50 - 20,0	1/4"	33,27	

					AV1...CR
	D1	L1	D min. - D max.	€	
	mm	mm	mm		1/4"
AV101CR	10,00	40	2,0 - 5,0	22,66	1/4"
AV102CR	14,00	42	5,0 - 10,0	28,33	1/4"
AV103CR	17,00	45	5,0 - 13,0	50,73	1/4"
AV104CR	25,00	55	7,0 - 20,0	90,60	1/4"

FERRAMENTAS COM CABO SEXTAVAVADO 1/4"

BROCA PARA PAREDE

Ref. BWH

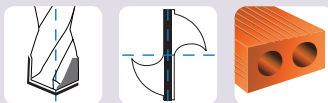

BROCA PARA MADEIRA

Ref. BMH

CV



BWH				
	Ø mm	L1 x L2 mm		€
BWH03	3	70 x 30	1/4"	3,23
BWH04	4	70 x 30	1/4"	3,50
BWH05	5	85 x 45	1/4"	3,79
BWH06	6	100 x 50	1/4"	4,21
BWH07	7	100 x 50	1/4"	4,95
BWH08	8	120 x 70	1/4"	5,72
BWH09	9	120 x 70	1/4"	6,85
BWH10	10	120 x 70	1/4"	7,67
BWH11	11	150 x 80	1/4"	9,54
BWH12	12	150 x 80	1/4"	10,78
BWH13	13	150 x 80	1/4"	13,27
BWH14	14	150 x 80	1/4"	15,46

BMH				
	Ø mm	L1 x L2 mm		€
BMH03	3	59 x 35	1/4"	2,07
BMH04	4	74 x 41	1/4"	2,17
BMH05	5	82 x 55	1/4"	2,15
BMH06	6	88 x 58	1/4"	2,90
BMH07	7	110 x 70	1/4"	3,29
BMH08	8	110 x 70	1/4"	3,42
BMH09	9	110 x 70	1/4"	3,56
BMH10	10	115 x 75	1/4"	3,94
BMH11	11	135 x 85	1/4"	4,60
BMH12	12	135 x 85	1/4"	5,40
BMH13	13	135 x 90	1/4"	8,45
BMH14	14	145 x 95	1/4"	10,51



REFERÊNCIA	BWH9318	BWH9327	BWH9319	BMH9335	BMH9333
Nº BROCAS	5	5	8	5	8
APLICAÇÃO	PAREDE	PAREDE	PAREDE	MADEIRA	MADEIRA
CONTEÚDO	Ø 3 - 4 - 5 - 6 - 8 mm	Ø 4 - 5 - 6 - 8 - 10 mm	Ø 3 - 4 - 5 - 6 - 7 - 8 - 9 - 10 mm	Ø 3 - 4 - 5 - 6 - 8 mm	Ø 3 - 4 - 5 - 6 - 7 - 8 - 9 - 10 mm
P.V.P. €	27,28	32,92	37,70	16,93	22,33

ESTOJOS DE FERRAMENTAS COM CABO SEXTAVAVADO 1/4"



Ref. EB



Ref. EMBP

CONTEÚDO

					€
EM	M3 - M4 - M5 - M6 M8 - M10	-	-	-	72,19
EMBP	M3 - M4 - M5 - M6 M8 - M10	Ø 2,50 - 3,30 - 4,20 5 - 6,80 - 8,50	-	-	104,08
EBM	-	-	M3 - M4 - M5 - M6 M8 - M10	-	158,91
EA	-	-	-	Ø 6,30 - 8,30 - 10,40 12,40 - 16,50 - 20,50	145,70
EB	-	Ø 1 - 10 mm x 0,50	-	-	121,39