

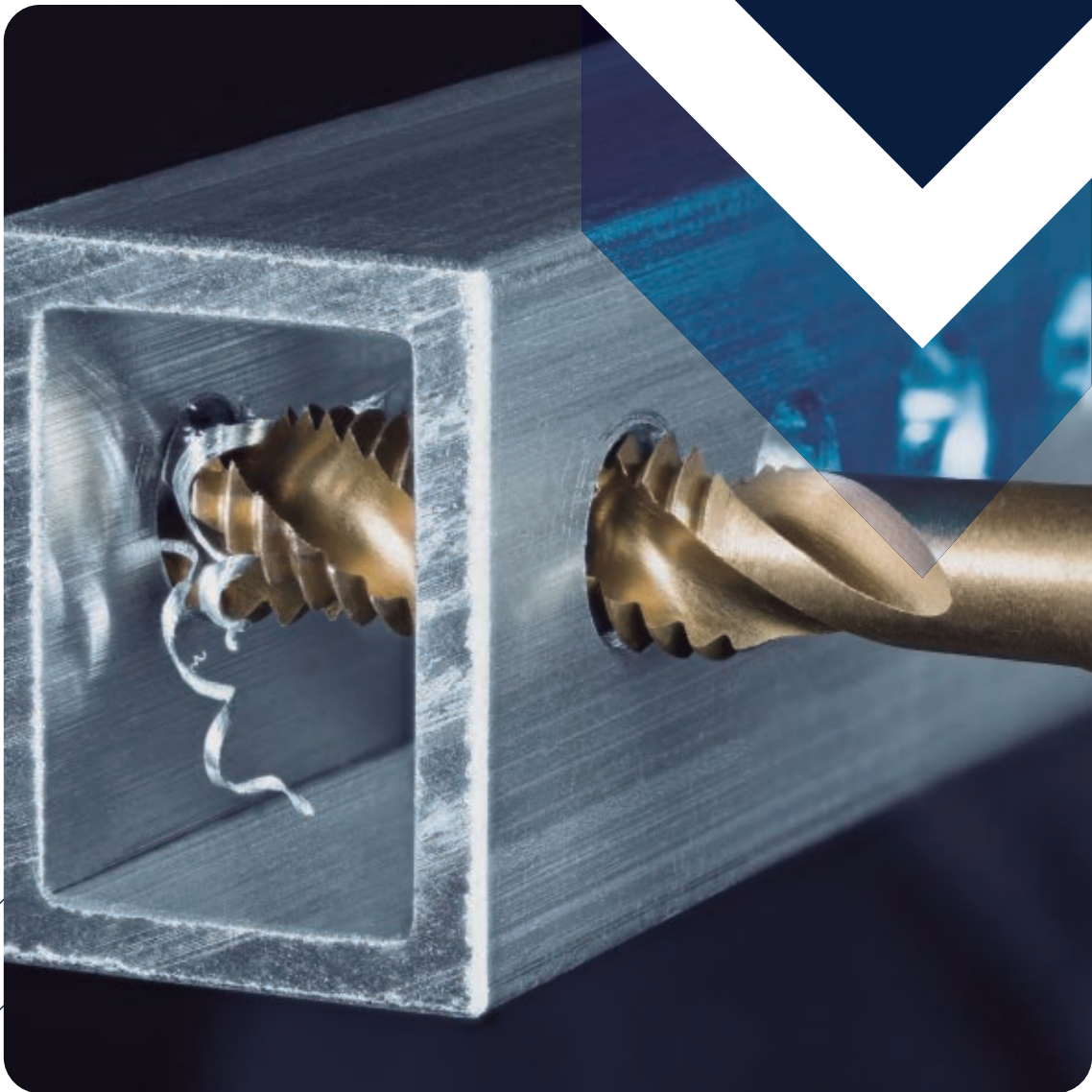

**BLUE-MASTER<sup>®</sup>**  
by *CELESA*

The logo for Blue-Master by CeleSA, featuring the brand name in a bold, sans-serif font with a registered trademark symbol, and the manufacturer's name 'by CELESA' in a smaller, italicized font below it.

THREADING  
TOOLS

The text 'THREADING TOOLS' is written in a large, thin, white, sans-serif font, positioned in the bottom right corner of the page.

## HSS HAND TAPS AND DIES

Threading tools

Green

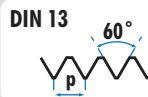

Ref. M0

HSS

(M)

DIN  
352

(MF)

DIN  
2181TOL  
6H

Ref. C5

HSS

DIN  
223TOL  
6g

For hardness materials up to 38 HRC

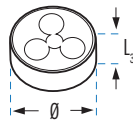
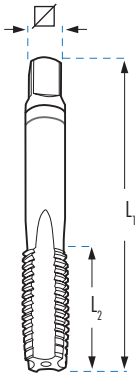

| Pcs.       | Ø | L1 x L2 x mm | M0             |           | C5      |        |
|------------|---|--------------|----------------|-----------|---------|--------|
|            |   |              | €              | Ø x L3 mm | €       | €      |
| M 5,5x0,90 | 3 | 4,60         | 50 x 16 x 4,9  | 95,70     | 25 x 9  | 109,86 |
| M 6x0,50   | 2 | 5,50         | 50 x 14 x 4,9  | 32,50     | 20 x 5  | 42,50  |
| M 6x0,75   | 2 | 5,25         | 50 x 14 x 4,9  | 27,43     | 25 x 9  | 34,86  |
| M 6x1,00   | 3 | 5,00         | 50 x 19 x 4,9  | 24,29*    | 25 x 9  | 31,02* |
| M 6x1,25   | 3 | 4,75         | 50 x 19 x 4,9  | 157,01    | 25 x 9  | 112,49 |
| M 7x0,75   | 2 | 6,25         | 50 x 14 x 4,9  | 36,01     | 25 x 9  | 34,51  |
| M 7x1,00   | 3 | 6,00         | 50 x 19 x 4,9  | 29,59*    | 25 x 9  | 32,56* |
| M 7x1,25   | 3 | 5,75         | 50 x 19 x 4,9  | 109,10    | 25 x 9  | 135,20 |
| M 8x0,50   | 2 | 7,50         | 50 x 16 x 4,9  | 57,32     | 25 x 9  | 51,53  |
| M 8x0,75   | 2 | 7,25         | 50 x 16 x 4,9  | 37,73     | 25 x 9  | 37,32  |
| M 8x1,00   | 2 | 7,00         | 56 x 18 x 4,9  | 27,30*    | 25 x 9  | 35,98* |
| M 8x1,25   | 3 | 6,80         | 56 x 22 x 4,9  | 29,56*    | 25 x 9  | 32,91* |
| M 8x1,50   | 3 | 6,50         | 56 x 22 x 4,9  | 106,11    | 25 x 9  | 117,54 |
| M 9x1,00   | 2 | 8,00         | 63 x 18 x 5,5  | 39,97     | 25 x 9  | 39,99  |
| M 9x1,25   | 3 | 7,80         | 63 x 22 x 5,5  | 48,43*    | 25 x 9  | 38,25* |
| M 10x0,50  | 2 | 9,50         | 63 x 18 x 5,5  | 59,10     | 30 x 10 | 129,87 |
| M 10x0,75  | 2 | 9,25         | 63 x 18 x 5,5  | 60,43     | 30 x 11 | 63,85  |
| M 10x1,00  | 2 | 9,00         | 63 x 18 x 5,5  | 29,23     | 38 x 10 | 42,34  |
| M 10x1,25  | 2 | 8,80         | 70 x 24 x 5,5  | 29,63     | 38 x 10 | 45,16  |
| M 10x1,50  | 3 | 8,50         | 70 x 24 x 5,5  | 36,45*    | 38 x 10 | 44,05* |
| M 11x0,75  | 2 | 10,25        | 63 x 18 x 6,2  | 88,73     | 30 x 11 | 140,31 |
| M 11x1,00  | 2 | 10,00        | 63 x 18 x 6,2  | 55,90     | 30 x 11 | 66,82  |
| M 11x1,25  | 2 | 9,75         | 63 x 20 x 6,2  | 55,90     | 30 x 11 | 66,81  |
| M 11x1,50  | 3 | 9,50         | 70 x 24 x 6,2  | 60,76     | 38 x 10 | 53,37  |
| M 12x0,75  | 2 | 11,25        | 70 x 20 x 7,0  | 80,68     | 38 x 10 | 72,45  |
| M 12x1,00  | 2 | 11,00        | 70 x 20 x 7,0  | 51,83     | 38 x 10 | 63,85  |
| M 12x1,25  | 2 | 10,75        | 70 x 20 x 7,0  | 51,68     | 38 x 10 | 61,56  |
| M 12x1,50  | 2 | 10,50        | 70 x 20 x 7,0  | 44,03*    | 38 x 10 | 55,21* |
| M 12x1,75  | 3 | 10,20        | 75 x 29 x 7,0  | 51,28*    | 38 x 14 | 47,86* |
| M 13x0,75  | 2 | 12,25        | 70 x 20 x 9,0  | 91,18     | 38 x 10 | 127,74 |
| M 13x1,00  | 2 | 12,00        | 70 x 20 x 9,0  | 87,78     | 38 x 10 | 67,84  |
| M 13x1,25  | 2 | 11,75        | 70 x 20 x 9,0  | 80,13     | 38 x 10 | 90,71  |
| M 13x1,50  | 2 | 11,50        | 70 x 20 x 9,0  | 80,13     | 38 x 10 | 71,31  |
| M 13x1,75  | 3 | 11,25        | 70 x 20 x 9,0  | 92,72     | 38 x 14 | 76,41  |
| M 14x0,75  | 2 | 13,25        | 70 x 20 x 9,0  | 104,78    | 38 x 10 | 119,77 |
| M 14x1,00  | 2 | 13,00        | 70 x 20 x 9,0  | 80,78     | 38 x 10 | 71,61  |
| M 14x1,25  | 2 | 12,80        | 70 x 20 x 9,0  | 63,10*    | 38 x 10 | 71,61* |
| M 14x1,50  | 2 | 12,50        | 70 x 20 x 9,0  | 49,07     | 38 x 10 | 60,96  |
| M 14x1,75  | 2 | 12,25        | 70 x 20 x 9,0  | 98,13     | 38 x 14 | 203,96 |
| M 14x2,00  | 3 | 12,00        | 80 x 30 x 9,0  | 56,73*    | 38 x 14 | 47,39* |
| M 15x1,00  | 2 | 14,00        | 70 x 20 x 9,0  | 113,18    | 45 x 14 | 77,11  |
| M 15x1,25  | 2 | 13,75        | 70 x 20 x 9,0  | 117,27    | 45 x 14 | 119,46 |
| M 15x1,50  | 2 | 13,50        | 70 x 20 x 9,0  | 104,99    | 45 x 14 | 82,61  |
| M 15x2,00  | 3 | 13,00        | 80 x 30 x 9,0  | 113,43    | 45 x 14 | 103,55 |
| M 16x1,00  | 2 | 15,00        | 70 x 20 x 9,0  | 107,16    | 45 x 14 | 87,31  |
| M 16x1,25  | 2 | 14,75        | 70 x 20 x 9,0  | 112,80    | 45 x 14 | 73,46  |
| M 16x1,50  | 2 | 14,50        | 70 x 20 x 9,0  | 61,06*    | 45 x 14 | 68,58* |
| M 16x2,00  | 3 | 14,00        | 80 x 32 x 9,0  | 81,17*    | 45 x 18 | 64,25* |
| M 17x1,00  | 2 | 16,00        | 70 x 20 x 9,0  | 173,07    | 45 x 14 | 124,94 |
| M 17x1,25  | 2 | 15,75        | 70 x 20 x 9,0  | 173,07    | 45 x 14 | 124,94 |
| M 17x1,50  | 2 | 15,50        | 70 x 20 x 9,0  | 173,07    | 45 x 14 | 124,94 |
| M 18x1,00  | 2 | 17,00        | 80 x 22 x 11,0 | 119,14    | 45 x 14 | 92,32  |
| M 18x1,25  | 2 | 16,75        | 80 x 22 x 11,0 | 170,07    | 45 x 14 | 96,02  |

\* Check the price of left hand sets of taps and dies available in page 188.

\* Extra-fee of 20% for adjustable die

**HSS HAND TAPS AND DIES**

M  
MF

DIN 13



60°

Ref. M0

HSS

DIN  
352

DIN  
2181



TOL  
6H

Ref. C5

HSS

DIN  
223

TOL  
6g

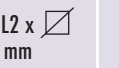
|  |      | M0  |                 |         |           | C5      |   |      |  |                 |          | M0        |         |   |      | C5  |              |   |           |   |
|--|------|---|-----------------|---------|-----------|---------|---|------|--|-----------------|----------|-----------|---------|---|------|---|--------------|---|-----------|---|
|  | Pcs. |  | L1 x L2 x mm    | €       | Ø x L3 mm | €       |  | Pcs. |  | L1 x L2 x mm    | €        | Ø x L3 mm | €       |  | Pcs. |  | L1 x L2 x mm | € | Ø x L3 mm | € |
| M 18x1,50  | 2    | 16,50   | 80 x 22 x 11,0  | 80,44   | 45 x 14   | 83,06   | M 33x3,50   | 3    | 29,5   | 125 x 50 x 20,0 | 390,08*  | 65 x 25   | 147,36* |   |      |   |              |   |           |   |
| M 18x2,00  | 2    | 16,00   | 80 x 22 x 11,0  | 128,40* | 45 x 14   | 92,80*  | M 34x1,50   | 2    | 32,5   | 100 x 25 x 22,0 | 400,85   | 65 x 18   | 168,65  |   |      |   |              |   |           |   |
| M 18x2,50  | 3    | 15,50   | 95 x 40 x 11,0  | 107,13* | 45 x 18   | 64,28*  | M 34x2,00   | 2    | 32,0   | 100 x 25 x 22,0 | 479,38   | 65 x 18   | 384,96  |   |      |   |              |   |           |   |
| M 19x1,00  | 2    | 18,00   | 80 x 22 x 11,0  | 251,18  | 45 x 14   | 154,96  | M 35x1,50   | 2    | 33,5   | 100 x 25 x 22,0 | 427,97   | 65 x 18   | 174,93  |   |      |   |              |   |           |   |
| M 19x1,25  | 2    | 17,75   | 80 x 22 x 11,0  | 251,18  | 45 x 14   | 175,26  | M 35x2,00   | 2    | 33,0   | 100 x 25 x 22,0 | 479,38   | 65 x 18   | 300,20  |   |      |   |              |   |           |   |
| M 19x1,50  | 2    | 17,50   | 80 x 22 x 11,0  | 251,18  | 45 x 14   | 154,96  | M 36x1,50   | 2    | 34,5   | 100 x 25 x 22,0 | 417,83   | 65 x 18   | 165,60  |   |      |   |              |   |           |   |
| M 19x2,00  | 2    | 17,00   | 80 x 22 x 11,0  | 298,17  | 45 x 14   | 177,03  | M 36x2,00   | 2    | 34,0   | 125 x 33 x 22,0 | 550,33   | 65 x 18   | 172,71  |   |      |   |              |   |           |   |
| M 20x1,00  | 2    | 19,00   | 80 x 22 x 12,0  | 162,19  | 45 x 14   | 92,32   | M 36x3,00   | 2    | 33,0   | 125 x 33 x 22,0 | 713,13*  | 65 x 25   | 173,28* |   |      |   |              |   |           |   |
| M 20x1,25  | 2    | 18,75   | 80 x 22 x 12,0  | 250,26  | 45 x 14   | 200,36  | M 36x4,00   | 3    | 32,0   | 150 x 53 x 22,0 | 502,21*  | 65 x 25   | 150,23* |   |      |   |              |   |           |   |
| M 20x1,50  | 2    | 18,50   | 80 x 22 x 12,0  | 100,74  | 45 x 14   | 84,98   | M 38x1,50   | 2    | 36,5   | 100 x 25 x 22,0 | 482,93   | 75 x 20   | 253,02  |   |      |   |              |   |           |   |
| M 20x2,00  | 2    | 18,00   | 80 x 22 x 12,0  | 136,00* | 45 x 14   | 92,32*  | M 38x2,00   | 2    | 36,0   | 125 x 25 x 22,0 | 649,97   | 75 x 20   | 373,86  |   |      |   |              |   |           |   |
| M 20x2,50  | 3    | 17,50   | 95 x 40 x 12,0  | 120,18* | 45 x 18   | 63,27*  | M 39x1,50   | 2    | 37,5   | 110 x 25 x 24,0 | 639,19   | 75 x 20   | 251,67  |   |      |   |              |   |           |   |
| M 21x1,00  | 2    | 20,00   | 80 x 22 x 12,0  | 321,81  | 45 x 14   | 189,84  | M 39x2,00   | 2    | 37,0   | 125 x 23 x 24,0 | 639,19   | 75 x 20   | 265,78  |   |      |   |              |   |           |   |
| M 21x1,25  | 2    | 19,75   | 80 x 22 x 12,0  | 321,81  | 45 x 14   | 189,84  | M 39x3,00   | 2    | 36,0   | 125 x 33 x 24,0 | 616,56*  | 75 x 30   | 271,46* |   |      |   |              |   |           |   |
| M 21x1,50  | 2    | 19,50   | 80 x 22 x 12,0  | 250,52  | 45 x 14   | 200,68  | M 39x4,00   | 3    | 35,0   | 150 x 53 x 24,0 | 561,94*  | 75 x 30   | 228,51* |   |      |   |              |   |           |   |
| M 22x1,00  | 2    | 21,00   | 80 x 22 x 14,5  | 181,77  | 55 x 16   | 124,27  | M 40x1,50   | 2    | 38,5   | 110 x 25 x 24,0 | 567,12   | 75 x 20   | 264,37  |   |      |   |              |   |           |   |
| M 22x1,25  | 2    | 20,75   | 80 x 22 x 14,5  | 247,85  | 55 x 16   | 202,51  | M 40x2,00   | 2    | 38,0   | 125 x 33 x 24,0 | 624,51   | 75 x 20   | 245,49  |   |      |   |              |   |           |   |
| M 22x1,50  | 2    | 20,50   | 80 x 22 x 14,5  | 110,80  | 55 x 16   | 106,90  | M 40x3,00   | 2    | 37,0   | 125 x 33 x 24,0 | 622,22   | 75 x 30   | 267,74  |   |      |   |              |   |           |   |
| M 22x2,00  | 2    | 20,00   | 80 x 22 x 14,5  | 176,74* | 55 x 16   | 118,94* | M 42x1,50   | 2    | 40,5   | 110 x 25 x 24,0 | 616,44   | 75 x 20   | 293,95  |   |      |   |              |   |           |   |
| M 22x2,50  | 3    | 19,50   | 100 x 40 x 14,5 | 160,08* | 55 x 22   | 95,08*  | M 42x2,00   | 2    | 40,0   | 125 x 33 x 24,0 | 730,75   | 75 x 20   | 310,82  |   |      |   |              |   |           |   |
| M 23x1,00  | 2    | 22,00   | 80 x 22 x 14,5  | 324,61  | 55 x 16   | 205,35  | M 42x3,00   | 2    | 39,0   | 125 x 33 x 24,0 | 733,90   | 75 x 30   | 293,95  |   |      |   |              |   |           |   |
| M 23x1,50  | 2    | 21,50   | 80 x 22 x 14,5  | 323,35  | 55 x 16   | 243,45  | M 42x4,50   | 3    | 37,5   | 150 x 53 x 24,0 | 703,09   | 75 x 30   | 228,49  |   |      |   |              |   |           |   |
| M 24x1,00  | 2    | 23,00   | 90 x 22 x 14,5  | 196,13  | 55 x 16   | 121,20  | M 45x1,50   | 2    | 43,5   | 110 x 25 x 29,0 | 673,32   | 90 x 22   | 343,49  |   |      |   |              |   |           |   |
| M 24x1,25  | 2    | 22,75   | 90 x 22 x 14,5  | 320,56  | 55 x 16   | 160,91  | M 45x2,00   | 2    | 43,0   | 125 x 33 x 29,0 | 877,59   | 90 x 22   | 372,89  |   |      |   |              |   |           |   |
| M 24x1,50  | 2    | 22,50   | 90 x 22 x 14,5  | 141,24  | 55 x 16   | 108,92  | M 45x3,00   | 2    | 42,0   | 125 x 33 x 29,0 | 877,59   | 90 x 36   | 389,06  |   |      |   |              |   |           |   |
| M 24x2,00  | 2    | 22,00   | 90 x 22 x 14,5  | 210,75* | 55 x 16   | 121,20* | M 45x4,50   | 3    | 40,5   | 160 x 60 x 29,0 | 811,67   | 90 x 36   | 354,06  |   |      |   |              |   |           |   |
| M 24x3,00  | 3    | 21,00   | 110 x 50 x 14,5 | 190,94* | 55 x 22   | 95,08*  | M 48x1,50   | 2    | 46,5   | 140 x 33 x 29,0 | 751,72   | 90 x 22   | 335,65  |   |      |   |              |   |           |   |
| M 25x1,00  | 2    | 24,00   | 90 x 22 x 14,5  | 276,69  | 55 x 16   | 183,94  | M 48x2,00   | 2    | 46,0   | 140 x 33 x 29,0 | 1.146,95 | 90 x 22   | 367,66  |   |      |   |              |   |           |   |
| M 25x1,25  | 2    | 23,75   | 90 x 22 x 14,5  | 362,36  | 55 x 16   | 242,19  | M 48x3,00   | 2    | 45,0   | 140 x 33 x 29,0 | 1.063,46 | 90 x 36   | 354,68  |   |      |   |              |   |           |   |
| M 25x1,50  | 2    | 23,50   | 90 x 22 x 14,5  | 261,04  | 55 x 16   | 158,22  | M 48x5,00   | 3    | 43,0   | 180 x 65 x 29,0 | 977,24   | 90 x 36   | 354,48  |   |      |   |              |   |           |   |
| M 25x2,00  | 2    | 23,00   | 90 x 22 x 14,5  | 471,88  | 55 x 16   | 235,47  | M 50x1,50   | 2    | 48,5   | 140 x 33 x 29,0 | 822,10   | 90 x 22   | 350,00  |   |      |   |              |   |           |   |
| M 26x1,00  | 2    | 25,00   | 90 x 22 x 14,5  | 247,33  | 55 x 16   | 182,31  | M 50x3,00   | 2    | 57,0   | 140 x 33 x 29,0 | 1.097,87 | 90 x 22   | 381,44  |   |      |   |              |   |           |   |
| M 26x1,50  | 2    | 24,50   | 90 x 22 x 14,5  | 232,06  | 55 x 16   | 146,98  | M 52x1,50   | 2    | 50,5   | 140 x 33 x 32,0 | 862,35   | 90 x 22   | 357,40  |   |      |   |              |   |           |   |
| M 26x2,00  | 2    | 24,00   | 90 x 22 x 14,5  | 272,28  | 55 x 16   | 206,02  | M 52x2,00   | 2    | 50,0   | 140 x 33 x 32,0 | 1.251,19 | 90 x 22   | 415,35  |   |      |   |              |   |           |   |
| M 27x1,00  | 2    | 26,00   | 90 x 22 x 16,0  | 272,30  | 65 x 18   | 164,00  | M 52x3,00   | 2    | 49,0   | 140 x 33 x 32,0 | 1.151,95 | 90 x 36   | 453,25  |   |      |   |              |   |           |   |
| M 27x1,50  | 2    | 25,50   | 90 x 22 x 16,0  | 262,92  | 65 x 18   | 164,70  | M 52x5,00   | 3    | 47,0   | 180 x 65 x 32,0 | 1.170,45 | 90 x 36   | 354,48  |   |      |   |              |   |           |   |
| M 27x2,00  | 2    | 25,00   | 90 x 22 x 16,0  | 292,08* | 65 x 18   | 179,13* | M 56x4,00   | 2    | 52,0   | 180 x 47 x 32,0 | 1.284,50 | 105 x 36  |         |   |      |   |              |   |           |   |
| M 27x3,00  | 3    | 24,00   | 110 x 50 x 16,0 | 241,45* | 65 x 25   | 144,22* | M 56x5,50   | 3    | 50,5   | 200 x 85 x 35,0 | 1.816,67 | 105 x 36  |         |   |      |   |              |   |           |   |
| M 28x1,00  | 2    | 27,00   | 90 x 22 x 16,0  | 459,59  | 65 x 18   | 212,00  | M 60x5,50   | 3    | 54,5   | 200 x 85 x 35,0 | 1.887,89 | 105 x 36  |         |   |      |   |              |   |           |   |
| M 28x1,50  | 2    | 26,50   | 90 x 22 x 16,0  | 257,79  | 65 x 18   | 149,31  | M 64x4,00   | 2    | 60,0   | 180 x 50 x 35,0 | 1.809,03 | 120 x 36  |         |   |      |   |              |   |           |   |
| M 28x2,00  | 2    | 26,00   | 90 x 22 x 16,0  | 308,43  | 65 x 18   | 209,93  | M 64x6,00   | 3    | 58,0   | 220 x 90 x 39,0 | 2.233,84 | 120 x 36  |         |   |      |   |              |   |           |   |
| M 30x1,00  | 2    | 29,00   | 90 x 22 x 18,0  | 286,27  | 65 x 18   | 173,80  | M 68x6,00   | 3    | 62,0   | 220 x 90 x 39,0 | 2.674,33 | 120 x 36  |         |   |      |   |              |   |           |   |
| M 30x1,50  | 2    | 28,50   | 90 x 22 x 18,0  | 274,73  | 65 x 18   | 164,69  | M 72x6,00   | 3    | 66,0   | 235 x 90 x 39,0 | 2.897,34 | 120 x 36  |         |   |      |   |              |   |           |   |
| M 30x2,00  | 2    | 28,00   | 90 x 22 x 18,0  | 316,74  | 65 x 18   | 182,52  |   |      |  |                 |          |           |         |   |      |   |              |   |           |   |
| M 30x3,00  | 2    | 27,00   | 125 x 56 x 18,0 | 309,64* | 65 x 25   | 203,31* |   |      |  |                 |          |           |         |   |      |   |              |   |           |   |
| M 30x3,50  | 3    | 26,50   | 125 x 50 x 18,0 | 310,65* | 65 x 25   | 144,59* |   |      |  |                 |          |           |         |   |      |   |              |   |           |   |
| M 32x1,00  | 2    | 31,00   | 90 x 22 x 18,0  | 377,52  | 65 x 18   | 224,48  |   |      |  |                 |          |           |         |   |      |   |              |   |           |   |
| M 32x1,50  | 2    | 30,50   | 90 x 22 x 18,0  | 327,12  | 65 x 18   | 170,81  |   |      |  |                 |          |           |         |   |      |   |              |   |           |   |
| M 32x2,00  | 2    | 30,00   | 90 x 22 x 18,0  | 468,23  | 65 x 18   | 208,05  |   |      |  |                 |          |           |         |   |      |   |              |   |           |   |
| M 33x1,00  | 2    | 32,00   | 100 x 25 x 20,0 | 602,47  | 65 x 18   | 237,69  |   |      |  |                 |          |           |         |   |      |   |              |   |           |   |
| M 33x1,50  | 2    | 31,50   | 100 x 25 x 20,0 | 349,86  | 65 x 18   | 161,63  |   |      |  |                 |          |           |         |   |      |   |              |   |           |   |
| M 33x2,00  | 2    | 31,00   | 100 x 25 x 20,0 | 441,71  | 65 x 18   | 162,74  |   |      |  |                 |          |           |         |   |      |   |              |   |           |   |
| M 33x3,00  | 2    | 30,00   | 125 x 56 x 20,0 | 557,35* | 65 x 25   | 251,14* |   |      |  |                 |          |           |         |   |      |   |              |   |           |   |

**DIES WITH EXTERNAL Ø AVAILABLE IN INCHES**

|          |            | C5    |           |             |       |
|----------|------------|-------|-----------|-------------|-------|
|          | Ø x L3 mm  | €     | Ø x L3 mm | €           |       |
| M 3x0,50 | 25,4 x 9,5 | 26,59 | M 8x1,25  | 38,1 x 12,7 | 28,22 |
| M 4x0,70 | 25,4 x 9,5 | 26,59 | M 10x1,50 | 25,4 x 9,50 | 35,72 |
| M 5x0,80 | 25,4 x 9,5 | 27,09 | M 10x1,50 | 38,1 x 12,7 | 35,72 |
| M 6x1,00 | 25,4 x 9,5 | 26,59 | M 12x1,75 | 25,4 x 9,50 | 43,04 |
| M 8x1,25 | 25,4 x 9,5 | 28,22 | M 12x1,75 | 38,1 x 12,7 | 43,04 |

\* Check the price of left hand sets of taps and dies available in page 188.  
\* Extra-fee of 20% for adjustable die

Threading tools  
Green

**HSS HAND TAPS AND DIES**
**UNC**

Ref. M0

HSS

DIN  
351TOL  
2B

Ref. C5

HSS

DIN  
223TOL  
2a
**UNF**

Ref. M0



HSS



DIN  
2181TOL  
2B

Ref. C5

HSS

DIN  
223TOL  
2a

|  | Pcs. | D1<br>mm |  | L1 x L2 x<br>mm | M0       |              | C5     |  |
|--|------|----------|---|-----------------|----------|--------------|--------|--|
|  |      |          |   |                 | €        | Ø x L3<br>mm | €      |  |
| UNC n°1-64h.   | 3    | 1,85     | 1,50  | 36x8x2,1        | 113,74   | 16x5         |        |  |
| UNC n°2-56h.   | 3    | 2,18     | 1,80  | 36x9x2,1        | 80,38    | 16x5         |        |  |
| UNC n°3-48h.   | 3    | 2,51     | 2,10  | 40x9x2,1        | 80,38    | 16x5         |        |  |
| UNC n°4-40h.   | 3    | 2,84     | 2,25  | 40x11x2,7       | 60,87    | 20x5         | 45,17  |  |
| UNC n°5-40h.   | 3    | 3,17     | 2,60  | 40x11x2,7       | 58,20    | 20x5         | 45,29  |  |
| UNC n°6-32h.   | 3    | 3,50     | 2,75  | 45x13x3,0       | 58,20    | 20x7         | 45,29  |  |
| UNC n°8-32h.   | 3    | 4,17     | 3,50  | 45x13x3,4       | 58,20    | 20x7         | 45,29  |  |
| UNC n°10-24h.  | 3    | 4,83     | 3,90  | 50x16x4,9       | 58,20    | 20x7         | 45,29  |  |
| UNC n°12-24h.  | 3    | 5,49     | 4,50  | 50x19x4,9       | 58,20    | 20x7         | 45,29  |  |
| UNC 1/4-20h.   | 3    | 6,35     | 5,10  | 50x19x4,9       | 49,87*   | 20x7         | 42,68* |  |
| UNC 5/16-18h.  | 3    | 7,94     | 6,60  | 56x22x4,9       | 56,62*   | 25x9         | 43,80* |  |
| UNC 3/8-16h.   | 3    | 9,52     | 8,00  | 70x24x5,5       | 64,42*   | 30x11        | 60,89* |  |
| UNC 7/16-14h.  | 3    | 11,11    | 9,40  | 70x24x6,2       | 83,88    | 38x14        | 60,89  |  |
| UNC 1/2-13h.   | 3    | 12,70    | 10,75   | 75x29x7,0       | 96,51*   | 38x14        | 62,59* |  |
| UNC 9/16-12h.  | 3    | 14,28    | 12,20   | 80x30x9,0       | 113,94   | 38x14        | 65,51  |  |
| UNC 5/8-11h.   | 3    | 15,87    | 13,50   | 80x32x9,0       | 157,14*  | 45x18        | 88,80* |  |
| UNC 3/4-10h.   | 3    | 19,05    | 16,50   | 95x40x11,0      | 214,11*  | 45x18        | 88,80* |  |
| UNC 7/8-9h.  | 3    | 22,22    | 19,50   | 100x40x14,5     | 263,57   | 55x22        | 123,97 |  |
| UNC 1.1/4-7h.  | 3    | 31,75    | 28,00   | 125x56x18,0     | 675,44   | 65x25        | 177,06 |  |
| UNC 1.3/8-6h.  | 3    | 34,92    | 30,75   | 150x63x22,0     | 856,88   | 65x25        | 177,06 |  |
| UNC 1.1/2-6h.  | 3    | 38,10    | 34,00   | 150x63x24,0     | 1.052,07 | 75x30        | 276,06 |  |
| UNC 2"-4,5h.   | 3    | 50,80    | 45,00   | 180x75x32,0     | 1.430,05 | 90x36        |        |  |

|  | Pcs. | D1<br>mm |  | L1 x L2 x<br>mm | M0       |              | C5      |  |
|---|------|----------|---|-----------------|----------|--------------|---------|--|
|   |      |          |   |                 | €        | Ø x L3<br>mm | €       |  |
| UNF n°2-64h.  | 2    | 2,18     | 1,85  | 36x8x2,1        | 72,83    |              |         |  |
| UNF n°3-56h.  | 2    | 2,51     | 2,15  | 40x9x2,1        | 72,83    |              |         |  |
| UNF n°4-48h.  | 2    | 2,84     | 2,35  | 40x9x2,7        | 45,38    | 20x5         | 46,94   |  |
| UNF n°5-44h.  | 2    | 3,17     | 2,70  | 45x10x2,7       | 45,38    | 20x5         | 45,29   |  |
| UNF n°6-40h.  | 2    | 3,50     | 2,95  | 45x16x3,0       | 43,37    | 20x5         | 45,29   |  |
| UNF n°8-36h.  | 2    | 4,17     | 3,50  | 50x12x3,4       | 43,37    | 20x7         | 45,29   |  |
| UNF n°10-32h.   | 2    | 4,83     | 4,10  | 50x12x4,9       | 43,37    | 20x7         | 45,29   |  |
| UNF n°12-28h.   | 2    | 5,49     | 4,60  | 50x12x4,9       | 45,38    | 20x7         | 45,29   |  |
| UNF 1/4-28h.  | 2    | 6,35     | 5,50  | 50x14x4,9       | 33,10*   | 25x9         | 39,98*  |  |
| UNF 5/16-24h.   | 2    | 7,94     | 6,90  | 56x22x4,9       | 35,44*   | 25x9         | 44,63*  |  |
| UNF 3/8-24h.  | 2    | 9,52     | 8,50  | 63x20x5,5       | 40,92*   | 38x10        | 60,89*  |  |
| UNF 7/16-20h.   | 2    | 11,11    | 9,90  | 63x20x6,2       | 54,30    | 38x10        | 59,74   |  |
| UNF 1/2-20h.  | 2    | 12,70    | 11,50   | 70x22x7,0       | 55,56*   | 38x10        | 65,09*  |  |
| UNF 9/16-18h.   | 2    | 14,29    | 12,90   | 70x22x9,0       | 72,40    | 38x10        | 68,13   |  |
| UNF 5/8-18h.  | 2    | 15,87    | 14,50   | 70x22x9,0       | 93,52*   | 45x14        | 88,80*  |  |
| UNF 3/4-16h.  | 2    | 19,05    | 17,50   | 80x22x11,0      | 125,62*  | 45x14        | 88,80*  |  |
| UNF 7/8-14h.  | 2    | 22,22    | 20,40   | 80x22x14,5      | 161,44*  | 55x16        | 119,19* |  |
| UNF 1"-12h.   | 2    | 25,40    | 23,25   | 90x22x16,0      | 214,06   | 55x16        | 119,19  |  |
| UNF 1"-14h.   | 2    | 25,40    | 23,60   | 90x22x14,5      | 237,14*  | 55x16        | 129,51* |  |
| UNF 1.1/8-12h.  | 2    | 28,57    | 26,50   | 90x22x18,0      | 315,95   | 65x18        | 145,16  |  |
| UNF 1.1/4-12h.  | 2    | 31,75    | 29,50   | 90x22x20,0      | 385,87   | 65x18        | 184,14  |  |
| UNF 1.3/8-12h.  | 2    | 34,92    | 32,80   | 125x35x22,0     | 520,58   | 65x18        | 192,76  |  |
| UNF 1.1/2-12h.  | 2    | 38,10    | 36,00   | 125x40x22,0     | 657,67   | 75x20        | 276,06  |  |
| UNF 2"-12h.   | 2    | 50,80    | 48,38   | 140x40x29,0     | 1.627,34 | 90x22        |         |  |

\* Check the price of left hand sets of taps and dies available in page 188.

**HSS HAND TAPS AND DIES**

**BSP (GAS)** Ref. M0 **DIN 5157 TOL ISO 228** Ref. C5 **DIN 5158** Ref. MOT Ref. MOX **DIN 5157 TOL 6H** Ref. CST Ref. C5X **DIN 5158 TOL 6g**



| Tap/Die Icon | Pcs. | D1 mm  | L1 x L2 x mm | M0              |          | C5       |         | MOT         |   | CST    |        | MOX    |        | C5X   |   |
|--------------|------|--------|--------------|-----------------|----------|----------|---------|-------------|---|--------|--------|--------|--------|-------|---|
|              |      |        |              | HSS             | €        | HSS      | €       | HSS         | € | HSS    | €      | HSSCo  | €      | HSSCo | € |
|              |      |        |              |                 |          |          |         |             |   |        |        |        |        |       |   |
|              |      |        |              |                 |          |          |         |             |   |        |        |        |        |       |   |
| G 1/8-28h.   | 2    | 9,73   | 8,80         | 63 x 20 x 5,5   | 37,01*   | 38 x 10  | 54,45*  | G 1/8-28 h. | 2 | 80,55  | 101,51 | 92,55  | 69,02  |       |   |
| G 1/4-19h.   | 2    | 13,16  | 11,80        | 70 x 22 x 9,0   | 52,16*   | 38 x 10  | 54,16*  | G 1/4-19 h. | 2 | 146,54 | 105,05 | 166,30 | 71,19  |       |   |
| G 3/8-19h.   | 2    | 16,66  | 15,25        | 70 x 22 x 9,0   | 65,48*   | 45 x 14  | 71,73*  | G 3/8-19 h. | 2 | 178,79 | 118,17 | 206,59 | 84,69  |       |   |
| G 1/2-14h.   | 2    | 20,95  | 19,00        | 80 x 22 x 12,0  | 91,83*   | 45 x 14  | 71,73*  | G 1/2-14 h. | 2 | 251,98 | 133,77 | 278,74 | 93,71  |       |   |
| G 5/8-14h.   | 2    | 22,91  | 21,00        | 80 x 22 x 14,5  | 117,50*  | 55 x 16  | 99,51*  |             |   |        |        |        |        |       |   |
| G 3/4-14h.   | 2    | 26,44  | 24,50        | 90 x 22 x 16,0  | 143,35*  | 55 x 16  | 129,53* | G 3/4-14 h. | 2 | 330,58 | 217,94 | 400,09 | 159,84 |       |   |
| G 7/8-14h.   | 2    | 30,20  | 28,25        | 90 x 22 x 18,0  | 192,98   | 65 x 18  | 154,20  |             |   |        |        |        |        |       |   |
| G 1"-11h.    | 2    | 33,25  | 30,75        | 100 x 25 x 20,0 | 227,25*  | 65 x 18  | 155,69* | G 1" -11 h. | 2 | 576,15 | 291,11 | 658,06 | 190,95 |       |   |
| G 1.1/8-11h. | 2    | 37,90  | 35,50        | 125 x 40 x 22,0 | 362,65   | 75 x 20  | 219,74  |             |   |        |        |        |        |       |   |
| G 1.1/4-11h. | 2    | 41,91  | 39,50        | 125 x 40 x 24,0 | 395,20*  | 75 x 20  | 215,70* |             |   |        |        |        |        |       |   |
| G 1.3/8-11h. | 2    | 44,32  | 42,00        | 125 x 40 x 29,0 | 536,77   | 90 x 22  | 338,02  |             |   |        |        |        |        |       |   |
| G 1.1/2-11h. | 2    | 47,80  | 45,25        | 140 x 40 x 29,0 | 597,26   | 90 x 22  | 325,60  |             |   |        |        |        |        |       |   |
| G 1.3/4-11h. | 2    | 53,75  | 51,25        | 140 x 40 x 32,0 | 992,93   | 105 x 22 | 338,02  |             |   |        |        |        |        |       |   |
| G 2"-11h.    | 2    | 59,61  | 57,00        | 160 x 40 x 35,0 | 1.104,06 | 105 x 22 | 406,80  |             |   |        |        |        |        |       |   |
| G 2.1/4-11h. | 2    | 65,71  | 63,00        | 160 x 40 x 39,0 | 1.823,79 | 105 x 22 |         |             |   |        |        |        |        |       |   |
| G 2.1/2-11h. | 2    | 75,18  | 72,50        | 160 x 40 x 39,0 | 2.741,36 | 120 x 22 |         |             |   |        |        |        |        |       |   |
| G 2.3/4-11h. | 2    | 81,53  | 79,00        | 160 x 40 x 39,0 | 3.324,15 | 120 x 22 |         |             |   |        |        |        |        |       |   |
| G 3"-11h.    | 2    | 87,88  | 85,50        | 160 x 40 x 39,0 | 3.459,76 | 150 x 25 |         |             |   |        |        |        |        |       |   |
| G 4"-11h.    | 2    | 113,03 | 110,50       | 180 x 45 x 44,0 | 5.247,27 | 180 x 25 |         |             |   |        |        |        |        |       |   |

**UNF 3B** Ref. M0 **HSS** **DIN 2181** **TOL 3B**

| Tap/Die Icon   | Pcs. | D1 mm | L1 x L2 x mm | M0-3B     |       |
|----------------|------|-------|--------------|-----------|-------|
|                |      |       |              | €         |       |
|                |      |       |              | €         |       |
| UNF n°4-48-3B  | 2    | 2,84  | 2,35         | 40x9x2,7  | 57,80 |
| UNF n°5-44-3B  | 2    | 3,17  | 2,70         | 45x10x2,7 | 57,80 |
| UNF n°6-40-3B  | 2    | 3,50  | 2,95         | 45x16x3,0 | 54,53 |
| UNF n°8-36-3B  | 2    | 4,17  | 3,50         | 50x12x3,4 | 54,53 |
| UNF n°10-32-3B | 2    | 4,83  | 4,10         | 50x12x4,9 | 54,53 |
| UNF n°12-28-3B | 2    | 5,49  | 4,60         | 50x12x4,9 | 57,80 |
| UNF 1/4-28-3B  | 2    | 6,35  | 5,50         | 50x14x4,9 | 42,16 |
| UNF 5/16-24-3B | 2    | 7,94  | 6,90         | 56x22x4,9 | 45,13 |
| UNF 3/8-24-3B  | 2    | 9,52  | 8,50         | 63x20x5,5 | 52,11 |
| UNF 7/16-20-3B | 2    | 11,11 | 9,90         | 63x20x6,2 | 69,17 |
| UNF 1/2-20-3B  | 2    | 12,70 | 11,50        | 70x22x7,0 | 70,76 |

\* Check the price of left hand sets of taps and dies available in page 188.

Threading tools  
Pink  
Green

**HSS HAND TAPS AND DIES**

Threading tools

Pink  
Green

**BSW** Ref. M0 HSS DIN 351 TOL 2 Class  
Ref. C5 HSS DIN 223

DIN BS84 55°

**BSF** Ref. M0 HSS DIN 5157 TOL ISO 228  
Ref. C5 HSS DIN 223

DIN BS84 55°

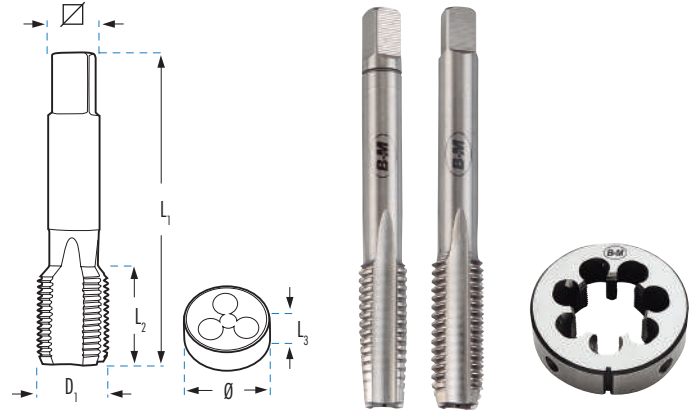

| Tap Profile   | Pcs. | D1 mm | Ø     | L1 x L2 x L3 mm | M0       |           | C5      |   |
|---------------|------|-------|-------|-----------------|----------|-----------|---------|---|
|               |      |       |       |                 | €        | Ø x L3 mm | €       | € |
| W 1/16-60h.   | 3    | 1,59  | 1,15  | 32x8x2,1        | 62,53    | 16x5      | 84,15   |   |
| W 3/32-48h.   | 3    | 2,38  | 1,80  | 40x9x2,1        | 45,72    | 20x5      | 43,42   |   |
| W 1/8-40h.    | 3    | 3,17  | 2,55  | 40x14x2,7       | 32,84*   | 25x9      | 34,27*  |   |
| W 5/32-32h.   | 3    | 3,97  | 3,10  | 45x17x3,4       | 33,18    | 25x9      | 34,96   |   |
| W 3/16-24h.   | 3    | 4,76  | 3,60  | 50x19x4,9       | 32,84    | 25x9      | 34,27   |   |
| W 7/32-24h.   | 3    | 5,55  | 4,40  | 50x19x4,9       | 54,01    | 25x9      | 44,76   |   |
| W 1/4-20h.    | 3    | 6,35  | 5,10  | 50x20x4,9       | 36,99*   | 25x9      | 34,96*  |   |
| W 5/16-18h.   | 3    | 7,94  | 6,50  | 56x20x4,9       | 45,18*   | 25x9      | 36,46*  |   |
| W 3/8-16h.    | 3    | 9,52  | 7,90  | 63x22x5,5       | 49,64*   | 38x10     | 52,77*  |   |
| W 7/16-14h.   | 3    | 11,11 | 9,25  | 70x22x6,2       | 66,63    | 38x10     | 52,84   |   |
| W 1/2-12h.    | 3    | 12,70 | 10,50 | 75x25x7,0       | 71,50    | 38x14     | 51,85   |   |
| W 9/16-12h.   | 3    | 14,29 | 12,00 | 80x26x9,0       | 97,27    | 38x14     | 63,32   |   |
| W 5/8-11h.    | 3    | 15,87 | 13,40 | 80x27x9,0       | 111,86*  | 45x18     | 75,30*  |   |
| W 11/16-11h.  | 3    | 17,46 | 15,25 | 95x32x11,0      | 263,61   | 45x18     | 124,04  |   |
| W 3/4-10h.    | 3    | 19,05 | 16,50 | 95x32x11,0      | 159,24*  | 45x18     | 75,42*  |   |
| W 7/8-9h.     | 3    | 22,22 | 19,25 | 100x32x14,5     | 217,47*  | 55x22     | 110,89* |   |
| W 1" - 8h.    | 3    | 25,40 | 21,75 | 110x36x14,5     | 266,51*  | 55x22     | 111,90* |   |
| W 1.1/8-7h.   | 3    | 28,57 | 24,75 | 125x40x18,0     | 395,03   | 65x25     | 176,20  |   |
| W 1.1/4-7h.   | 3    | 31,75 | 27,75 | 125x40x18,0     | 477,94   | 65x25     | 176,27  |   |
| W 1.3/8-6h.   | 3    | 34,92 | 30,50 | 150x50x22,0     | 594,34   | 65x25     | 179,53  |   |
| W 1.1/2-6h.   | 3    | 38,10 | 33,50 | 150x50x24,0     | 715,56   | 75x30     | 272,90  |   |
| W 1.5/8-5h.   | 3    | 41,27 | 46,50 | 150x56x24,0     | 996,00   | 75x30     | 339,81  |   |
| W 1.3/4-5h.   | 3    | 44,45 | 39,00 | 160x58x29,0     | 1.225,84 | 90x36     | 427,66  |   |
| W 1.7/8-4,5h. | 3    | 47,62 | 42,00 | 180x65x29,0     | 1.583,24 | 90x36     | 467,95  |   |
| W 2" - 4,5h.  | 3    | 50,80 | 44,50 | 180x65x32,0     | 1.662,13 | 90x36     | 490,41  |   |
| W 2.1/4-4h.   | 3    | 57,15 | 50,00 | 200x85x35,0     | 2.754,08 | 105x36    |         |   |
| W 2.1/2-4h.   | 3    | 63,50 | 56,50 | 220x85x39,0     | 3.350,38 | 120x36    |         |   |
| W 2.3/4-3,5h. | 3    | 69,85 | 62,00 | 250x90x44,0     | 4.783,95 | 120x36    |         |   |
| W 3" - 3,5h.  | 3    | 76,20 | 68,00 | 250x90x44,0     | 5.534,50 | 140x36    |         |   |

| Tap Profile   | Pcs. | D1 mm | Ø    | L1 x L2 x L3 mm | M0       |           | C5     |   |
|---------------|------|-------|------|-----------------|----------|-----------|--------|---|
|               |      |       |      |                 | €        | Ø x L3 mm | €      | € |
| BSF 3/16-32h. | 2    | 4,76  | 4,0  | 50x19x4,9       | 89,99    | 20x7      | 45,09  |   |
| BSF 1/4-26h.  | 2    | 6,35  | 5,2  | 50x20x4,9       | 50,26    | 20x7      | 49,93  |   |
| BSF 5/16-22h. | 2    | 7,94  | 6,6  | 56x20x4,9       | 58,61    | 25x9      | 50,50  |   |
| BSF 3/8-20h.  | 2    | 9,52  | 8,1  | 63x22x5,5       | 67,83    | 30x11     | 97,01  |   |
| BSF 7/16-18h. | 2    | 11,11 | 9,5  | 70x22x6,2       | 81,39    | 30x11     | 96,11  |   |
| BSF 1/2-16h.  | 2    | 12,70 | 11,0 | 75x25x7,0       | 92,08    | 38x10     | 83,87  |   |
| BSF 9/16-16h. | 2    | 14,29 | 12,5 | 80x26x9,0       | 110,37   | 38x10     | 88,51  |   |
| BSF 5/8-14h.  | 2    | 15,88 | 14,0 | 80x26x9,0       | 144,44   | 45x14     | 137,98 |   |
| BSF 3/4-12h.  | 2    | 19,05 | 16,5 | 95x33x11,0      | 220,77   | 45x14     | 139,26 |   |
| BSF 7/8-11h.  | 2    | 22,23 | 19,5 | 100x33x14,5     | 263,50   | 55x22     | 186,75 |   |
| BSF 1" - 10h. | 2    | 25,40 | 22,5 | 110x40x14,5     | 369,88   | 55x22     | 184,68 |   |
| BSF 1.1/8-9h. | 2    | 28,57 | 25,5 | 110x40x16,0     | 834,60   |           |        |   |
| BSF 1.1/4-9h. | 2    | 31,75 | 28,5 | 125x46x18,0     | 952,85   |           |        |   |
| BSF 1.1/2-8h. | 2    | 38,10 | 34,5 | 150x55x22,0     | 1.452,21 |           |        |   |

**BSW** **INOX** **TiN**

| Tap Profile  | Pcs. | L1 x L2 x L3 mm | M0T    |           | C5T    |   |
|--------------|------|-----------------|--------|-----------|--------|---|
|              |      |                 | €      | Ø x L3 mm | €      | € |
| W 3/16-24 h. | 3    | 50 x 19 x 4,90  | 62,70  | 25x9      | 62,67  |   |
| W 1/4-20 h.  | 3    | 50 x 20 x 4,90  | 70,18  | 25x9      | 63,82  |   |
| W 5/16-18 h. | 3    | 56 x 20 x 4,90  | 76,90  | 25x9      | 66,34  |   |
| W 3/8-16 h.  | 3    | 63 x 22 x 5,50  | 90,51  | 38x10     | 78,42  |   |
| W 1/2-12 h.  | 3    | 75 x 25 x 7,00  | 127,72 | 38x14     | 105,36 |   |



\* Check the price of left hand sets of taps and dies available in page 188.

**HSS HAND TAPS AND DIES**

**NPTF**

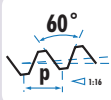

AMERICAN dryseal  
taper pipe thread

Ref. MO

**HSS**

Ref. C5

**HSS**

**DIN  
223**

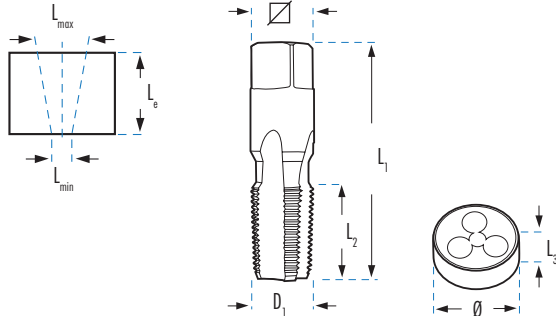

| Icon | Pcs. | D1<br>mm | Ø    | L min x L max<br>mm | Le<br>mm | L1 x L2 x<br>mm | MO            |              | C5            |  |
|------|------|----------|------|---------------------|----------|-----------------|---------------|--------------|---------------|--|
|      |      |          |      |                     |          |                 | €             | Ø x L3<br>mm | €             |  |
|      | 1    | 10,22    | 8,5  | 8,30 x 8,76         | 12,0     | 54 x 19 x 8,0   | <b>100,75</b> | 38 x 10      | <b>220,02</b> |  |
|      | 1    | 13,58    | 11,0 | 10,70 x 11,40       | 17,5     | 62 x 27 x 11,0  | <b>141,21</b> | 38 x 15      | <b>220,02</b> |  |
|      | 1    | 17,02    | 14,5 | 14,20 x 14,84       | 17,6     | 65 x 27 x 13,0  | <b>194,93</b> | 45 x 14      | <b>287,28</b> |  |
|      | 1    | 21,21    | 17,8 | 17,40 x 18,33       | 22,8     | 80 x 35 x 13,0  | <b>272,58</b> | 45 x 20      | <b>287,28</b> |  |
|      | 1    | 26,56    | 23,0 | 22,80 x 23,68       | 23,0     | 83 x 35 x 17,0  | <b>416,66</b> | 55 x 22      | <b>547,53</b> |  |
|      | 1    | 33,19    | 29,0 | 28,60 x 29,72       | 27,4     | 110 x 38 x 20,0 | <b>554,99</b> |              |               |  |

**NPT**

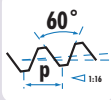

AMERICAN  
taper pipe thread (Briggs)

Ref. MO

**HSS**

Ref. C5

**HSS**

**DIN  
223**

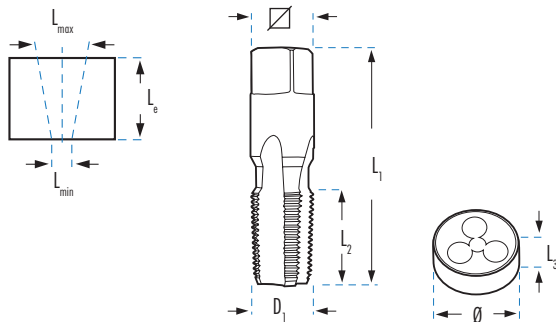

| Icon | Pcs. | D1<br>mm | Ø     | Material  | L min x L max<br>mm | Le<br>mm | L1 x L2 x<br>mm | MO              |              | C5            |  |
|------|------|----------|-------|-----------|---------------------|----------|-----------------|-----------------|--------------|---------------|--|
|      |      |          |       |           |                     |          |                 | €               | Ø x L3<br>mm | €             |  |
|      | 1    | 7,89     | 6,20  | EMNPT1/16 | 6,00 x 6,38         | 12,0     | 54 x 18 x 6,0   | <b>38,25</b>    | 25 x 9       | <b>126,47</b> |  |
|      | 1    | 10,24    | 8,50  | EMNPT1/8  | 8,30 x 8,73         | 12,0     | 65 x 19 x 5,5   | <b>38,25</b>    | 30 x 11      | <b>93,51</b>  |  |
|      | 1    | 13,62    | 11,00 | EMNPT1/4  | 10,70 x 11,35       | 17,5     | 62 x 27 x 11,0  | <b>53,67</b>    | 38 x 14      | <b>93,51</b>  |  |
|      | 1    | 17,05    | 14,50 | EMNPT3/8  | 14,20 x 14,80       | 17,6     | 65 x 27 x 13,0  | <b>74,07</b>    | 45 x 18      | <b>122,08</b> |  |
|      | 1    | 21,23    | 17,80 | EMNPT1/2  | 17,40 x 18,32       | 22,8     | 80 x 35 x 13,0  | <b>103,57</b>   | 45 x 18      | <b>122,08</b> |  |
|      | 1    | 26,57    | 23,00 | -         | 22,80 x 23,66       | 23,0     | 83 x 35 x 17,0  | <b>158,33</b>   | 55 x 22      | <b>223,32</b> |  |
|      | 1    | 33,23    | 29,00 | -         | 28,60 x 29,69       | 27,4     | 95 x 44 x 21,0  | <b>176,34</b>   | 65 x 25      | <b>268,47</b> |  |
|      | 1    | 41,98    | 37,50 | -         | 37,40 x 38,45       | 28,1     | 125 x 33 x 24,0 | <b>289,12</b>   | 75 x 26      | <b>333,62</b> |  |
|      | 1    | 48,05    | 44,00 | -         | 43,40 x 44,52       | 28,4     | 140 x 33 x 29,0 | <b>439,33</b>   | 90 x 27      | <b>465,46</b> |  |
|      | 1    | 60,09    | 56,00 | -         | 55,50 x 56,56       | 28,4     | 160 x 33 x 35,0 | <b>685,88</b>   | 105 x 36     | <b>648,03</b> |  |
|      | 1    | 73,03    | 67,00 | -         | 68,68 x 69,08       | 28,9     | 200 x 45 x 39,0 | <b>838,07</b>   |              |               |  |
|      | 1    | 88,90    | 82,00 | -         | 84,45 x 84,86       | 30,5     | 220 x 48 x 39,0 | <b>1.178,01</b> |              |               |  |

\* Also available prior reamer on page 137

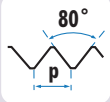
**HSS HAND TAPS AND DIES**
**PG**

Ref. M0

**HSS**
**DIN  
40430**

Ref. C5

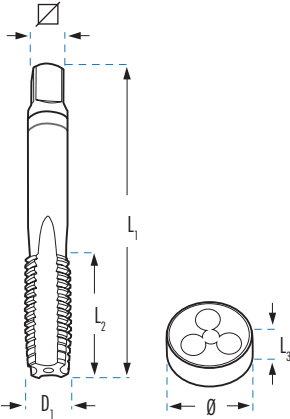
**HSS**
**DIN  
223**

| Tap Profile | Pcs. | D1<br>mm | Ø    | L1 x L2 x<br>mm | M0          |              | C5     |        |
|-------------|------|----------|------|-----------------|-------------|--------------|--------|--------|
|             |      |          |      |                 | €           | Ø x L3<br>mm | €      |        |
| Pg 7        | 20h. | 1        | 12,5 | 11,50           | 70x20x7,0   | 36,68        | 38x10  | 67,44  |
| Pg 9        | 18h. | 1        | 15,2 | 14,00           | 70x20x9,0   | 46,63        | 38x10  | 67,44  |
| Pg 11       | 18h. | 1        | 18,6 | 17,25           | 80x22x11,0  | 64,75        | 45x14  | 84,44  |
| Pg 13,5     | 18h. | 1        | 20,4 | 19,00           | 80x22x12,0  | 71,00        | 45x14  | 84,44  |
| Pg 16       | 18h. | 1        | 22,5 | 21,25           | 80x22x14,5  | 85,27        | 55x16  | 108,93 |
| Pg 21       | 16h. | 1        | 28,3 | 27,00           | 90x22x18,0  | 125,39       | 65x18  | 154,84 |
| Pg 29       | 16h. | 1        | 37,0 | 35,50           | 100x25x22,0 | 248,98       | 65x18  | 154,84 |
| Pg 36       | 16h. | 1        | 47,0 | 45,50           | 140x32x29,0 | 408,60       | 90x22  | 396,87 |
| Pg 42       | 16h. | 1        | 54,0 | 52,50           | 140x36x32,0 | 485,24       | 105x22 | 396,87 |
| Pg 48       | 16h. | 1        | 59,3 | 58,00           | 160x36x35,0 | 611,98       | 105x22 | 526,29 |

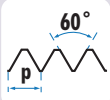
**NPSF**

 AMERICAN dryseal  
 straight pipe thread

Ref. M0

**HSS**

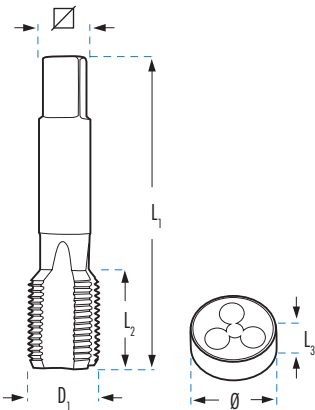
Ref. C5

**HSS**
**DIN  
223**

| Tap Profile    | Pcs. | D1<br>mm | Ø     | L1 x L2 x<br>mm | M0     |              | C5     |  |
|----------------|------|----------|-------|-----------------|--------|--------------|--------|--|
|                |      |          |       |                 | €      | Ø x L3<br>mm | €      |  |
| NPSF 1/8-27 h. | 1    | 10,05    | 8,75  | 63x18x5,5       | 151,72 | 38x10        | 264,30 |  |
| NPSF 1/4-18 h. | 1    | 13,35    | 11,30 | 70x20x9,0       | 219,24 | 38x10        | 264,30 |  |
| NPSF 3/8-18 h. | 1    | 16,78    | 14,70 | 70x20x9,0       | 303,25 | 45x14        | 336,22 |  |
| NPSF 1/2-14 h. | 1    | 20,87    | 18,20 | 80x22x12,0      | 396,43 | 45x14        | 336,22 |  |
| NPSF 3/4-14 h. | 1    | 26,23    | 23,50 | 90x22x16,0      | 603,18 | 55x16        | 726,76 |  |

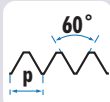
**NPS  
(M)**

 AMERICAN  
 straight pipe thread

Ref. M0

**HSS**

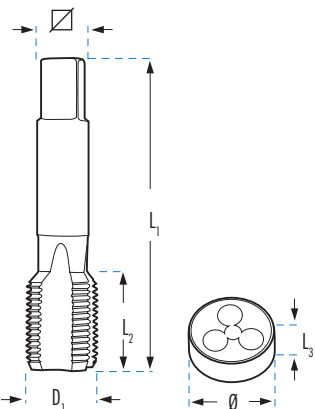
Ref. C5

**HSS**
**DIN  
223**

| Tap Profile    | Pcs. | D1<br>mm | Ø    | L1 x L2 x<br>mm | M0     |              | C5     |  |
|----------------|------|----------|------|-----------------|--------|--------------|--------|--|
|                |      |          |      |                 | €      | Ø x L3<br>mm | €      |  |
| NPS 1/8-27 h.  | 1    | 10,20    | 8,9  | 63x18x5,5       | 125,71 | 38x10        | 220,19 |  |
| NPS 1/4-18 h.  | 1    | 13,60    | 11,7 | 70x20x9,0       | 100,04 | 38x10        | 220,19 |  |
| NPS 3/8-18 h.  | 1    | 17,00    | 15,0 | 70x20x9,0       | 138,37 | 45x14        | 280,17 |  |
| NPS 1/2-14 h.  | 1    | 21,20    | 18,6 | 80x22x12,0      | 180,86 | 45x14        | 280,17 |  |
| NPS 3/4-14 h.  | 1    | 26,55    | 24,0 | 90x22x16,0      | 262,64 | 55x16        | 555,02 |  |
| NPS 1"-11,5 h. | 1    | 33,20    | 30,0 | 100x25x20,0     | 367,24 | 65x18        | 559,34 |  |

**HSS HAND TAPS AND DIES**

**BSPT**

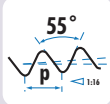

Ref. MO

**HSS**

**DIN  
5157**

Ref. C5

**HSS**

**DIN  
223**

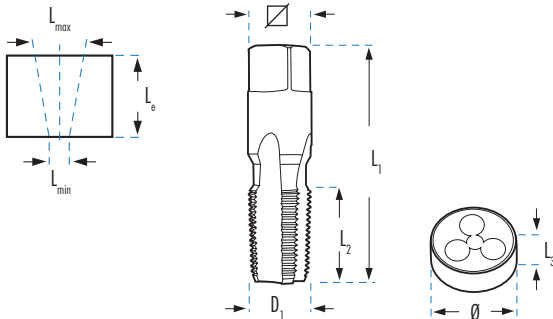

| Icon | Pcs. | D1<br>mm | Ø     | L min x L max<br>mm | L <sub>e</sub><br>mm | L1 x L2 x L3<br>mm | MO     |              | C5     |  |
|------|------|----------|-------|---------------------|----------------------|--------------------|--------|--------------|--------|--|
|      |      |          |       |                     |                      |                    | €      | Ø x L3<br>mm | €      |  |
|      | 1    | 9,73     | 8,30  | 8,00 x 8,50         | 10,1                 | 65 x 19 x 5,5      | 34,25  | 30 x 11      | 102,09 |  |
|      | 1    | 13,16    | 11,00 | 10,70 x 11,35       | 15,0                 | 70 x 25 x 9,0      | 48,26  | 38 x 14      | 102,09 |  |
|      | 1    | 16,66    | 14,50 | 14,15 x 14,25       | 15,4                 | 70 x 25 x 9,0      | 67,01  | 45 x 16      | 132,96 |  |
|      | 1    | 20,95    | 18,10 | 17,60 x 18,50       | 20,5                 | 80 x 31 x 12,0     | 93,83  | 55 x 22      | 132,96 |  |
|      | 1    | 22,91    | 20,00 | 19,50 x 20,40       | 22,4                 | 80 x 36 x 14,5     | 164,55 | 55 x 19      | 277,45 |  |
|      | 1    | 26,44    | 23,50 | 23,00 x 24,00       | 21,8                 | 85 x 33 x 16,0     | 153,11 | 55 x 22      | 251,09 |  |
|      | 1    | 30,20    | 27,25 | 26,65 x 28,75       | 24,0                 | 100 x 36 x 18,0    | 290,16 | 65 x 22      | 362,48 |  |
|      | 1    | 33,25    | 29,60 | 29,00 x 30,20       | 26,0                 | 110 x 38 x 20,0    | 242,48 | 65 x 25      | 289,96 |  |

**BA**

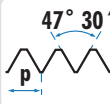

Ref. MO

**HSS**

**DIN  
352**

Ref. C5

**HSS**

**DIN  
223**

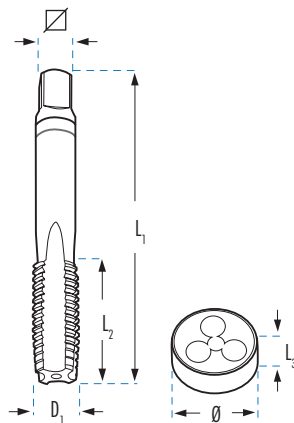

| Icon | Pcs. | D1<br>mm | Ø   | L1 x L2 x L3<br>mm | MO            |              | C5     |        |
|------|------|----------|-----|--------------------|---------------|--------------|--------|--------|
|      |      |          |     |                    | €             | Ø x L3<br>mm | €      |        |
|      | 1,00 | 3        | 6,0 | 5,1                | 50 x 18 x 4,9 | 213,39       | 20 x 5 | 166,83 |
|      | 0,90 | 3        | 5,3 | 4,5                | 50 x 18 x 4,9 | 213,39       | 20 x 5 | 166,83 |
|      | 0,81 | 3        | 4,7 | 4,0                | 50 x 17 x 4,9 | 213,39       | 20 x 5 | 166,83 |
|      | 0,73 | 3        | 4,1 | 3,4                | 45 x 14 x 3,4 | 229,31       | 20 x 5 | 166,83 |
|      | 0,66 | 3        | 3,6 | 3,0                | 45 x 14 x 3,0 | 229,31       | 20 x 5 | 166,83 |
|      | 0,59 | 3        | 3,2 | 2,6                | 45 x 14 x 3,0 | 273,99       | 20 x 5 | 166,83 |
|      | 0,53 | 3        | 2,8 | 2,3                | 40 x 12 x 2,7 | 273,99       | 20 x 5 | 166,83 |
|      | 0,48 | 3        | 2,5 | 2,0                | 40 x 10 x 2,1 | 301,23       | 20 x 5 | 166,83 |
|      | 0,43 | 3        | 2,2 | 1,8                | 36 x 10 x 2,1 | 301,23       | 20 x 5 | 166,83 |

**HSS HAND TAPS AND DIES**

Threading tools

Green

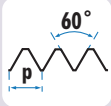

**UNx8**

 AMERICAN  
 thread pitch

Ref. M0

**HSS**
**DIN  
2181**
**TOL  
2B**

Ref. C5

**HSS**
**DIN  
223**
**TOL  
2a**

|  | Pcs. | D1<br>mm |  | L1 x L2 x<br>mm | M0              |              | C5            |  |
|---|------|----------|---|-----------------|-----------------|--------------|---------------|--|
|   |      |          |   |                 | €               | Ø x L3<br>mm | €             |  |
| UN 1"1/8-8h.  | 2    | 28,57    | 25,40   | 138x65x17,0     | <b>402,39</b>   | 65x25        | <b>440,73</b> |  |
| UN 1"1/4-8h.  | 2    | 31,75    | 28,50   | 146x65x19,5     | <b>521,83</b>   | 65x25        | <b>440,73</b> |  |
| UN 1"3/8-8h.  | 2    | 34,92    | 31,75   | 154x76x21,0     | <b>649,01</b>   | 65x25        | <b>438,79</b> |  |
| UN 1"1/2-8h.  | 2    | 38,10    | 35,00   | 162x76x23,5     | <b>742,74</b>   | 75x30        | <b>496,75</b> |  |
| UN 1"5/8-8h.  | 2    | 41,27    | 38,10   | 170x80x25,0     | <b>923,43</b>   | 75x30        | <b>519,95</b> |  |
| UN 1"3/4-8h.  | 2    | 44,45    | 41,25   | 178x81x27,0     | <b>1.150,84</b> | 90x36        | <b>693,29</b> |  |
| UN 1"7/8-8h.  | 2    | 47,62    | 44,45   | 186x90x29,0     | <b>1.435,74</b> | 90x36        | <b>741,81</b> |  |
| UN 2"-8h.   | 2    | 50,80    | 47,63   | 194x90x31,5     | <b>1.364,97</b> | 90x36        | <b>751,06</b> |  |
| UN 2"1/4-8h.  | 2    | 57,15    | 54,00   | 208x90x36,0     |                 |              |               |  |
| UN 2"1/2-8h.  | 2    | 63,50    | 60,35   | 220x100x36,0    |                 |              |               |  |
| UN 2"3/4-8h.  | 2    | 69,85    | 66,70   | 234x104x39,0    |                 |              |               |  |
| UN 3"-8h.   | 2    | 76,20    | 73,05   | 248x115x49,0    |                 |              |               |  |

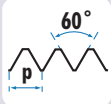

**UNEF**

 AMERICAN  
 extra fine thread

Ref. M0

**HSS**
**DIN  
2181**
**TOL  
2B**

Ref. C5

**HSS**
**DIN  
223**
**TOL  
2a**

|  | Pcs. | D1<br>mm |  | L1 x L2 x<br>mm | M0            |              | C5            |  |
|---|------|----------|---|-----------------|---------------|--------------|---------------|--|
|   |      |          |   |                 | €             | Ø x L3<br>mm | €             |  |
| UNEF 1/4-32h.   | 2    | 6,35     | 5,55  | 65x28x4,9       | <b>108,15</b> | 20x7         | <b>109,81</b> |  |
| UNEF 5/16-32h.  | 2    | 7,94     | 7,15  | 70x30x6,0       | <b>120,83</b> | 25x9         | <b>109,81</b> |  |
| UNEF 3/8-32h.   | 2    | 9,52     | 8,70  | 75x33x7,0       | <b>138,28</b> | 30x11        | <b>170,51</b> |  |
| UNEF 7/16-28h.  | 2    | 11,11    | 10,20   | 81x38x6,0       | <b>176,02</b> | 30x11        | <b>170,51</b> |  |
| UNEF 1/2-28h.   | 2    | 12,70    | 11,80   | 86x44x7,0       | <b>198,89</b> | 38x10        | <b>170,51</b> |  |
| UNEF 9/16-24h.  | 2    | 14,29    | 13,20   | 92x44x8,0       | <b>162,59</b> | 38x10        | <b>170,51</b> |  |
| UNEF 5/8-24h.   | 2    | 15,87    | 14,80   | 93x47x9,0       | <b>167,47</b> | 45x14        | <b>273,30</b> |  |
| UNEF 3/4-20h.   | 2    | 19,05    | 17,80   | 108x52x11,0     | <b>184,31</b> | 45x14        | <b>273,30</b> |  |
| UNEF 7/8-20h.   | 2    | 22,22    | 20,95   | 120x58x13,0     | <b>279,71</b> | 55x16        | <b>325,10</b> |  |
| UNEF 1"-20h.  | 2    | 25,40    | 24,20   | 130x65x15,0     | <b>287,70</b> | 55x16        | <b>334,01</b> |  |

**HAND TAPS, SPECIAL APPLICATIONS**



Ref. MOMD

**HSSCo**  
5%

**DIN**  
352

**OX**



HARD MATERIALS (< 1100 N/mm<sup>2</sup>=40Hrc )

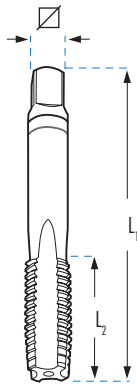

| MOMD        |      |       |                |        |
|-------------|------|-------|----------------|--------|
|             | Pcs. |       |                | €      |
|             |      | Ø     | L1 x L2 x mm   |        |
| M 3 x 0,50  | 3    | 2,50  | 40 x 11 x 2,7  | 39,47  |
| M 4 x 0,70  | 3    | 3,30  | 45 x 13 x 3,4  | 39,47  |
| M 5 x 0,80  | 3    | 4,20  | 50 x 17 x 4,9  | 40,75  |
| M 6 x 1,00  | 3    | 5,00  | 50 x 19 x 4,9  | 41,95  |
| M 8 x 1,25  | 3    | 6,80  | 56 x 20 x 4,9  | 47,70  |
| M 10 x 1,50 | 3    | 8,50  | 70 x 22 x 5,5  | 61,22  |
| M 12 x 1,75 | 3    | 10,20 | 75 x 24 x 7,0  | 87,66  |
| M 14 x 2,00 | 3    | 12,00 | 80 x 26 x 9,0  | 103,76 |
| M 16 x 2,00 | 3    | 14,00 | 80 x 27 x 9,0  | 137,87 |
| M 18 x 2,50 | 3    | 15,50 | 95 x 30 x 11,0 | 212,04 |
| M 20 x 2,50 | 3    | 17,50 | 95 x 32 x 12,0 | 235,41 |



Ref. MOC

**HSS**  
PM

**TiAlSiN**

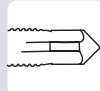

VERY HARD MATERIALS (< 1400 N/mm<sup>2</sup>=44Hrc )

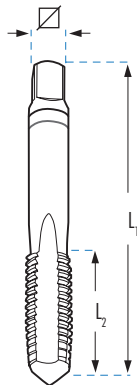

| MOC         |      |       |                |        |
|-------------|------|-------|----------------|--------|
|             | Pcs. |       |                | €      |
|             |      | Ø     | L1 x L2 x mm   |        |
| M 3 x 0,50  | 3    | 2,50  | 40 x 11 x 2,7  | 85,89  |
| M 4 x 0,70  | 3    | 3,30  | 45 x 13 x 3,4  | 92,67  |
| M 5 x 0,80  | 3    | 4,20  | 50 x 17 x 4,9  | 93,83  |
| M 6 x 1,00  | 3    | 5,00  | 50 x 19 x 4,9  | 93,83  |
| M 8 x 1,25  | 3    | 6,80  | 56 x 20 x 4,9  | 105,76 |
| M 10 x 1,50 | 3    | 8,50  | 70 x 22 x 5,5  | 130,73 |
| M 12 x 1,75 | 3    | 10,20 | 75 x 24 x 7,0  | 158,91 |
| M 14 x 2,00 | 3    | 12,00 | 80 x 26 x 9,0  | 190,66 |
| M 16 x 2,00 | 3    | 14,00 | 80 x 27 x 9,0  | 233,64 |
| M 18 x 2,50 | 3    | 15,50 | 95 x 30 x 11,0 | 323,93 |
| M 20 x 2,50 | 3    | 17,50 | 95 x 32 x 12,0 | 356,52 |

**AI**

Ref. MOAL

**HSS**

**BRIGHT**



SPECIAL FOR ALUMINIUM

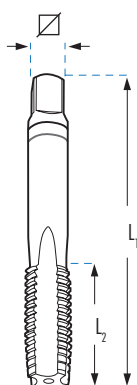

| MOAL        |      |       |                |        |
|-------------|------|-------|----------------|--------|
|             | Pcs. |       |                | €      |
|             |      | Ø     | L1 x L2 x mm   |        |
| M 3 x 0,50  | 3    | 2,50  | 40 x 11 x 2,7  | 30,74  |
| M 4 x 0,70  | 3    | 3,30  | 45 x 13 x 3,4  | 29,84  |
| M 5 x 0,80  | 3    | 4,20  | 50 x 17 x 4,9  | 31,62  |
| M 6 x 1,00  | 3    | 5,00  | 50 x 19 x 4,9  | 31,62  |
| M 8 x 1,25  | 3    | 6,80  | 56 x 20 x 4,9  | 38,81  |
| M 10 x 1,50 | 3    | 8,50  | 70 x 22 x 5,5  | 47,39  |
| M 12 x 1,75 | 3    | 10,20 | 75 x 24 x 7,0  | 66,72  |
| M 14 x 2,00 | 3    | 12,00 | 80 x 26 x 9,0  | 76,67  |
| M 16 x 2,00 | 3    | 14,00 | 80 x 27 x 9,0  | 108,83 |
| M 18 x 2,50 | 3    | 15,50 | 95 x 30 x 11,0 | 144,24 |
| M 20 x 2,50 | 3    | 17,50 | 95 x 32 x 12,0 | 162,61 |

## HAND TAPS AND DIES FOR STAINLESS STEEL

M

INOX

Ref. MOT  
Ref. MOXDIN  
352TOL  
6H

TiN

Ref. C5T  
Ref. C5XDIN  
223TOL  
6g

OX

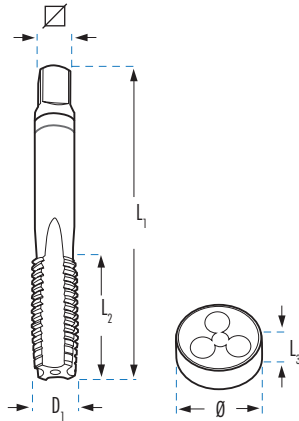

|   |           | Pcs. | L1 x L2 x L3<br>mm | MOT    | C5T    | MOX    | C5X   | Ø x L3<br>mm |
|---|-----------|------|--------------------|--------|--------|--------|-------|--------------|
|   |           |      |                    | HSS    | HSS    | HSSCo  | HSSCo |              |
|   |           |      |                    | TiN    | TiN    | OX     | OX    |              |
|   |           |      |                    | €      | €      | €      | €     |              |
| M | 3 x 0,50  | 3    | 40 x 11 x 2,70     | 44,01  | 64,71  | 40,59  | 35,15 | 20 x 5       |
| M | 4 x 0,70  | 3    | 45 x 13 x 3,40     | 46,24  | 64,71  | 40,59  | 35,15 | 20 x 5       |
| M | 5 x 0,80  | 3    | 50 x 16 x 4,90     | 49,06  | 64,71  | 42,26  | 36,85 | 20 x 7       |
| M | 6 x 1,00  | 3    | 50 x 19 x 4,90     | 49,06  | 64,71  | 42,13  | 37,37 | 20 x 7       |
| M | 8 x 1,00  | 2    | 50 x 19 x 4,90     | 43,13  |        |        |       |              |
| M | 8 x 1,25  | 3    | 56 x 22 x 4,90     | 56,58  | 66,34  | 49,03  | 40,53 | 25 x 9       |
| M | 10 x 1,00 | 2    | 63 x 18 x 5,50     | 49,76  |        |        |       |              |
| M | 10 x 1,50 | 3    | 70 x 24 x 5,50     | 75,35  | 87,10  | 63,08  | 51,43 | 30 x 11      |
| M | 12 x 1,50 | 2    | 70 x 20 x 7,00     | 63,36  |        |        |       |              |
| M | 12 x 1,75 | 3    | 75 x 29 x 7,00     | 87,43  | 96,57  | 90,33  | 54,33 | 38 x 14      |
| M | 14 x 1,50 | 2    | 70 x 20 x 9,00     | 76,08  |        |        |       |              |
| M | 14 x 2,00 | 3    | 80 x 30 x 9,00     | 105,73 | 96,57  | 100,03 | 54,33 | 38 x 14      |
| M | 16 x 2,00 | 3    | 80 x 32 x 9,00     | 132,78 | 119,01 | 137,09 | 72,94 | 45 x 18      |
| M | 18 x 2,50 | 3    | 95 x 40 x 11,00    | 164,59 |        | 187,23 |       |              |
| M | 20 x 2,50 | 3    | 95 x 40 x 12,00    | 170,68 |        | 207,82 |       |              |
| M | 22 x 2,50 | 3    | 100 x 40 x 14,50   | 215,91 |        |        |       |              |
| M | 24 x 3,00 | 3    | 110 x 50 x 14,50   | 260,17 |        |        |       |              |

M

**HSS HEXAGONAL DIES**

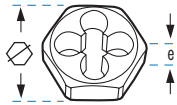

**M** **HSS** **DIN 382**

|              |  | C5HM    |        |
|--------------|--|---------|--------|
|              |  |         | €      |
| M 3 x 0,35   |  | 18 x 5  | 41,87  |
| M 3 x 0,50   |  | 19 x 5  | 41,87  |
| M 3,5 x 0,60 |  | 18 x 5  | 41,87  |
| M 4 x 0,50   |  | 18 x 5  | 41,87  |
| M 4 x 0,70   |  | 19 x 5  | 41,87  |
| M 5 x 0,50   |  | 18 x 5  | 41,87  |
| M 5 x 0,75   |  | 18 x 5  | 41,87  |
| M 5 x 0,80   |  | 19 x 7  | 41,87  |
| M 6 x 0,75   |  | 18 x 7  | 41,87  |
| M 6 x 1,00   |  | 19 x 7  | 41,87  |
| M 7 x 0,75   |  | 21 x 9  | 44,51  |
| M 7 x 1,00   |  | 21 x 9  | 44,51  |
| M 8 x 0,75   |  | 21 x 9  | 44,51  |
| M 8 x 1,00   |  | 21 x 9  | 44,51  |
| M 8 x 1,25   |  | 22 x 9  | 44,51  |
| M 9 x 0,75   |  | 21 x 9  | 52,39  |
| M 9 x 1,00   |  | 21 x 9  | 52,39  |
| M 9 x 1,25   |  | 22 x 9  | 52,39  |
| M 10 x 1,00  |  | 27 x 11 | 52,39  |
| M 10 x 1,25  |  | 27 x 11 | 52,39  |
| M 10 x 1,50  |  | 27 x 11 | 52,39  |
| M 11 x 1,00  |  | 27 x 11 | 87,29  |
| M 11 x 1,50  |  | 27 x 11 | 87,29  |
| M 12 x 1,25  |  | 36 x 10 | 87,29  |
| M 12 x 1,50  |  | 36 x 10 | 87,29  |
| M 12 x 1,75  |  | 36 x 10 | 73,34  |
| M 14 x 1,25  |  | 36 x 14 | 99,19  |
| M 14 x 1,50  |  | 36 x 10 | 99,19  |
| M 14 x 2,00  |  | 36 x 10 | 73,34  |
| M 15 x 1,00  |  | 36 x 14 | 115,05 |
| M 15 x 1,50  |  | 41 x 14 | 115,05 |
| M 16 x 1,00  |  | 41 x 14 | 115,05 |
| M 16 x 1,50  |  | 41 x 14 | 115,05 |

|             |  | C5HM    |        |
|-------------|--|---------|--------|
|             |  |         | €      |
| M 16 x 2,00 |  | 41 x 18 | 115,05 |
| M 18 x 1,00 |  | 41 x 14 | 115,05 |
| M 18 x 1,50 |  | 41 x 14 | 115,05 |
| M 18 x 2,50 |  | 41 x 18 | 115,05 |
| M 20 x 1,00 |  | 41 x 14 | 115,05 |
| M 20 x 1,50 |  | 41 x 14 | 115,05 |
| M 20 x 2,00 |  | 41 x 18 | 115,05 |
| M 20 x 2,50 |  | 41 x 18 | 115,05 |
| M 22 x 1,00 |  | 50 x 16 | 145,47 |
| M 22 x 1,50 |  | 50 x 16 | 145,47 |
| M 22 x 2,00 |  | 50 x 16 | 145,47 |
| M 22 x 2,50 |  | 50 x 16 | 145,47 |
| M 24 x 1,00 |  | 50 x 16 | 177,17 |
| M 24 x 1,50 |  | 50 x 16 | 177,17 |
| M 24 x 2,00 |  | 50 x 16 | 177,17 |
| M 24 x 3,00 |  | 50 x 22 | 145,47 |
| M 27 x 1,50 |  | 60 x 18 | 196,69 |
| M 27 x 2,00 |  | 60 x 18 | 196,69 |
| M 27 x 3,00 |  | 60 x 25 | 163,90 |
| M 30 x 1,00 |  | 60 x 18 | 196,69 |
| M 30 x 1,50 |  | 60 x 18 | 196,69 |
| M 30 x 2,00 |  | 60 x 18 | 196,69 |
| M 30 x 3,00 |  | 60 x 18 | 196,69 |
| M 30 x 3,50 |  | 60 x 25 | 163,90 |
| M 33 x 1,50 |  | 60 x 18 | 220,23 |
| M 33 x 2,00 |  | 60 x 18 | 220,23 |
| M 33 x 3,50 |  | 60 x 25 | 183,54 |
| M 35 x 1,50 |  | 60 x 18 | 227,04 |
| M 36 x 1,50 |  | 60 x 18 | 227,04 |
| M 36 x 2,00 |  | 60 x 18 | 227,04 |
| M 36 x 3,00 |  | 60 x 18 | 227,04 |
| M 36 x 4,00 |  | 60 x 25 | 189,20 |

**BSP (GAS)** **HSS** **DIN 382**

|               |  | C5HG     |        |
|---------------|--|----------|--------|
|               |  |          | €      |
| G 1/8 x 28h.  |  | 27 x 11  | 92,20  |
| G 1/4 x 19h.  |  | 36 x 10  | 92,20  |
| G 3/8 x 19h.  |  | 41 x 14  | 115,30 |
| G 1/2 x 14h.  |  | 41 x 14  | 115,30 |
| G 5/8 x 14h.  |  | 50 x 16  | 271,47 |
| G 3/4 x 14h.  |  | 50 x 16  | 271,47 |
| G 7/8 x 14h.  |  | 60 x 18  | 273,88 |
| G 1" x 11h.   |  | 60 x 18  | 273,88 |
| G1.1/4 x 11h. |  | 70 x 20  | 365,18 |
| G1.1/2 x 11h. |  | 85 x 22  | 616,07 |
| G 2" x 11h.   |  | 100 x 22 | 927,05 |

**UNC** **HSS** **DIN 382**

|              |  | C5HNC   |        |
|--------------|--|---------|--------|
|              |  |         | €      |
| UNC 1/4-20h  |  | 18 x 7  | 38,18  |
| UNC 5/16-18h |  | 21 x 9  | 47,51  |
| UNC 3/8-16h  |  | 27 x 11 | 57,35  |
| UNC 7/16-14h |  | 27 x 11 | 84,64  |
| UNC 1/2-13h  |  | 36 x 14 | 84,95  |
| UNC 9/16-12h |  | 36 x 14 | 101,52 |
| UNC 5/8-11h  |  | 41 x 18 | 78,65  |
| UNC 3/4-10h  |  | 41 x 18 | 125,11 |
| UNC 7/8-9h   |  | 50 x 22 | 177,55 |
| UNC 1"-8h    |  | 50 x 22 | 177,55 |
| UNC 1.1/8-7h |  | 60 x 25 | 234,75 |
| UNC 1.1/4-7h |  | 60 x 25 | 234,75 |

**UNF** **HSS** **DIN 382**

|                |  | C5HNF   |        |
|----------------|--|---------|--------|
|                |  |         | €      |
| UNF 1/4-28h.   |  | 18 x 7  | 40,47  |
| UNF 5/16-24h.  |  | 21 x 9  | 50,60  |
| UNF 3/8-24h.   |  | 27 x 11 | 60,88  |
| UNF 7/16-20h.  |  | 27 x 11 | 89,70  |
| UNF 1/2-20h.   |  | 36 x 10 | 91,08  |
| UNF 9/16-18h.  |  | 36 x 10 | 101,52 |
| UNF 5/8-18h.   |  | 41 x 14 | 126,65 |
| UNF 3/4-16h.   |  | 41 x 14 | 132,63 |
| UNF 7/8-14h.   |  | 50 x 16 | 167,75 |
| UNF 1"-12h.    |  | 50 x 16 | 175,84 |
| UNS 1"-14h.    |  | 50 x 16 | 175,84 |
| UNF 1.1/8-12h. |  | 60 x 18 | 234,75 |
| UNF 1.1/4-12h. |  | 60 x 18 | 234,75 |

**BSW** **HSS** **DIN 382**

|                 |  | C5HW    |       |
|-----------------|--|---------|-------|
|                 |  |         | €     |
| BSW 1/8 x 40h.  |  | 19 x 5  | 52,39 |
| BSW 3/16 x 24h. |  | 19 x 7  | 52,39 |
| BSW 1/4 x 20h.  |  | 19 x 7  | 52,39 |
| BSW 5/16 x 18h. |  | 22 x 9  | 54,99 |
| BSW 3/8 x 16h.  |  | 27 x 11 | 65,47 |
| BSW 7/16 x 14h. |  | 27 x 11 | 65,47 |
| BSW 1/2 x 12h.  |  | 36 x 14 | 78,59 |

|                 |  | C5HW    |        |
|-----------------|--|---------|--------|
|                 |  |         | €      |
| BSW 9/16 x 12h. |  | 36 x 14 | 78,59  |
| BSW 5/8 x 11h.  |  | 41 x 18 | 116,13 |
| BSW 3/4 x 10h.  |  | 41 x 18 | 116,13 |
| BSW 7/8 x 9h.   |  | 50 x 22 | 170,21 |
| BSW 1" x 8h.    |  | 50 x 22 | 170,21 |
| BSW 1.1/8 x 7h. |  | 60 x 25 | 293,37 |

## SET OF LEFT TURNING HAND TAPS AND DIES

M  
MF

DIN 13

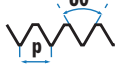

Ref. MOI

HSS

(M)

DIN  
352

(MF)

DIN  
2181TOL  
6H

Ref. CSI

HSS

DIN  
223TOL  
6g

For hard materials up to 38 HRC



LEFT

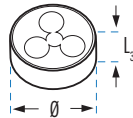
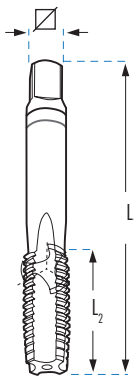

UNC

|               | Pcs. | D1<br>mm |       | L1 x L2 x<br>mm | MOI    |              | CSI    |  |
|---------------|------|----------|-------|-----------------|--------|--------------|--------|--|
|               |      |          |       |                 | €      | Ø x L3<br>mm | €      |  |
| UNC 1/4-20h.  | 3    | 6,35     | 5,10  | 50x19x4,9       | 99,75  | 20x7         | 85,37  |  |
| UNC 5/16-18h. | 3    | 7,94     | 6,60  | 56x22x4,9       | 113,24 | 25x9         | 87,59  |  |
| UNC 3/8-16h.  | 3    | 9,52     | 8,00  | 70x24x5,5       | 128,83 | 30x11        | 121,79 |  |
| UNC 1/2-13h.  | 3    | 12,70    | 10,75 | 75x29x7,0       | 193,02 | 38x14        | 125,19 |  |
| UNC 5/8-11h.  | 3    | 15,87    | 13,50 | 80x32x9,0       | 314,27 | 45x18        | 177,59 |  |
| UNC 3/4-10h.  | 3    | 19,05    | 16,50 | 95x40x11,0      | 428,21 | 45x18        | 177,59 |  |
| UNC 1"-8h.    | 3    | 25,40    | 22,25 | 110x50x14,5     | 711,81 | 55x22        | 238,38 |  |

UNF

|               | Pcs. | D1<br>mm |       | L1 x L2 x<br>mm | MOI    |              | CSI    |  |
|---------------|------|----------|-------|-----------------|--------|--------------|--------|--|
|               |      |          |       |                 | €      | Ø x L3<br>mm | €      |  |
| UNF 1/4-28h.  | 2    | 6,35     | 5,50  | 50x14x4,9       | 66,21  | 25x9         | 79,97  |  |
| UNF 5/16-24h. | 2    | 7,94     | 6,90  | 56x22x4,9       | 70,88  | 25x9         | 89,26  |  |
| UNF 3/8-24h.  | 2    | 9,52     | 8,50  | 63x20x5,5       | 81,84  | 38x10        | 121,79 |  |
| UNF 1/2-20h.  | 2    | 12,70    | 11,50 | 70x22x7,0       | 111,12 | 38x10        | 130,17 |  |
| UNF 5/8-18h.  | 2    | 15,87    | 14,50 | 70x22x9,0       | 187,05 | 45x14        | 177,59 |  |
| UNF 3/4-16h.  | 2    | 19,05    | 17,50 | 80x22x11,0      | 251,24 | 45x14        | 177,59 |  |
| UNS 1"-14h.   | 2    | 25,40    | 23,60 | 90x22x14,5      | 474,27 | 55x16        | 259,02 |  |

BSP  
(GAS)

|              | Pcs. | D1<br>mm |       | L1 x L2 x<br>mm | MOI    |              | CSI    |  |
|--------------|------|----------|-------|-----------------|--------|--------------|--------|--|
|              |      |          |       |                 | €      | Ø x L3<br>mm | €      |  |
| G 1/8-28h.   | 2    | 9,73     | 8,80  | 63 x 20 x 5,5   | 74,02  | 38x10        | 108,89 |  |
| G 1/4-19h.   | 2    | 13,16    | 11,80 | 70 x 22 x 9,0   | 104,32 | 38x10        | 108,31 |  |
| G 3/8-19h.   | 2    | 16,66    | 15,25 | 70 x 22 x 9,0   | 130,95 | 45x14        | 143,46 |  |
| G 1/2-14h.   | 2    | 20,95    | 19,00 | 80 x 22 x 12,0  | 183,67 | 45x14        | 143,46 |  |
| G 5/8-14h.   | 2    | 22,91    | 21,00 | 80 x 22 x 14,5  | 235,00 | 55x16        | 199,02 |  |
| G 3/4-14h.   | 2    | 26,44    | 24,50 | 90 x 22 x 16,0  | 286,69 | 55x16        | 259,07 |  |
| G 1"-11h.    | 2    | 33,25    | 30,75 | 100 x 25 x 20,0 | 454,50 | 65x18        | 311,39 |  |
| G 1.1/4-11h. | 2    | 41,91    | 39,50 | 125 x 40 x 24,0 | 790,40 | 75x20        | 431,41 |  |

BSW

|             | Pcs. | D1<br>mm |       | L1 x L2 x<br>mm | MOI    |              | CSI    |  |
|-------------|------|----------|-------|-----------------|--------|--------------|--------|--|
|             |      |          |       |                 | €      | Ø x L3<br>mm | €      |  |
| W 1/8-40h.  | 3    | 3,17     | 2,55  | 40x14x2,7       | 65,67  | 25x9         | 68,54  |  |
| W 1/4-20h.  | 3    | 6,35     | 5,10  | 50x20x4,9       | 73,97  | 25x9         | 69,92  |  |
| W 5/16-18h. | 3    | 7,94     | 6,50  | 56x20x4,9       | 90,35  | 25x9         | 72,92  |  |
| W 3/8-16h.  | 3    | 9,52     | 7,90  | 63x22x5,5       | 99,27  | 38x10        | 105,53 |  |
| W 5/8-11h.  | 3    | 15,87    | 13,40 | 80x27x9,0       | 223,72 | 45x18        | 150,61 |  |
| W 3/4-10h.  | 3    | 19,05    | 16,50 | 95x32x11,0      | 318,48 | 45x18        | 150,83 |  |
| W 7/8-9h.   | 3    | 22,22    | 19,25 | 100x32x14,5     | 434,95 | 55x22        | 221,78 |  |
| W 1"-8h.    | 3    | 25,40    | 21,75 | 110x36x14,5     | 533,03 | 55x22        | 223,80 |  |

|           | Pcs. | D1<br>mm | L1 x L2 x<br>mm | MOI      |              | CSI    |  |
|-----------|------|----------|-----------------|----------|--------------|--------|--|
|           |      |          |                 | €        | Ø x L3<br>mm | €      |  |
| M 2x0,40  | 3    | 1,60     | 36x9,0x2,1      | 81,02    | 16x5         | 68,21  |  |
| M 3x0,50  | 3    | 2,50     | 40x11,0x2,7     | 45,48    | 25x9         | 62,03  |  |
| M 4x0,70  | 3    | 3,30     | 45x13,0x3,4     | 45,44    | 25x9         | 62,35  |  |
| M 5x0,80  | 3    | 4,20     | 50x16,0x4,9     | 48,57    | 25x9         | 61,99  |  |
| M 6x1,00  | 3    | 5,00     | 50x19x4,9       | 48,57    | 25x9         | 62,03  |  |
| M 7x1,00  | 3    | 6,00     | 50x19x4,9       | 59,18    | 25x9         | 65,12  |  |
| M 8x1,00  | 2    | 7,00     | 56x18x4,9       | 54,59    | 25x9         | 71,97  |  |
| M 8x1,25  | 3    | 6,80     | 56x22x4,9       | 59,12    | 25x9         | 65,81  |  |
| M 9x1,25  | 3    | 7,80     | 63x22x5,5       | 96,86    | 25x9         | 76,50  |  |
| M 10x1,50 | 3    | 8,50     | 70x24x5,5       | 72,90    | 38x10        | 88,10  |  |
| M 12x1,50 | 2    | 10,50    | 70x20x7,0       | 88,07    | 38x10        | 110,42 |  |
| M 12x1,75 | 3    | 10,20    | 75x29x7,0       | 102,57   | 38x14        | 95,72  |  |
| M 14x1,25 | 2    | 12,80    | 70x20x9,0       | 126,20   | 38x10        | 143,22 |  |
| M 14x2,00 | 3    | 12,00    | 80x30x9,0       | 113,46   | 38x14        | 94,77  |  |
| M 16x1,50 | 2    | 14,50    | 70x20x9,0       | 122,12   | 45x14        | 137,15 |  |
| M 16x2,00 | 3    | 14,00    | 80x32x9,0       | 162,35   | 45x18        | 128,50 |  |
| M 18x2,00 | 2    | 16,00    | 80x22x11,0      | 256,80   | 45x14        | 185,60 |  |
| M 18x2,50 | 3    | 15,50    | 95x40x11,0      | 214,26   | 45x18        | 128,56 |  |
| M 20x2,00 | 2    | 18,00    | 80x22x12,0      | 272,00   | 45x14        | 184,63 |  |
| M 20x2,50 | 3    | 17,50    | 95x40x12,0      | 240,36   | 45x18        | 126,55 |  |
| M 22x2,00 | 2    | 20,00    | 80x22x14,5      | 353,48   | 55x16        | 237,89 |  |
| M 22x2,50 | 3    | 19,50    | 100x40x14,5     | 320,17   | 55x22        | 190,16 |  |
| M 24x2,00 | 2    | 22,00    | 90x22x14,5      | 421,50   | 55x16        | 242,40 |  |
| M 24x3,00 | 3    | 21,00    | 110x50x14,5     | 381,88   | 55x22        | 190,16 |  |
| M 27x2,00 | 2    | 25,00    | 90x22x16,0      | 584,15   | 65x18        | 358,26 |  |
| M 27x3,00 | 3    | 24,00    | 110x50x16,0     | 482,91   | 65x25        | 288,44 |  |
| M 30x3,00 | 2    | 27,00    | 125x56x18,0     | 619,28   | 65x25        | 406,62 |  |
| M 30x3,50 | 3    | 26,50    | 125x50x18,0     | 621,30   | 65x25        | 289,17 |  |
| M 33x2,00 | 2    | 31,00    | 100x25x20,0     | 883,41   | 65x18        | 502,28 |  |
| M 33x3,50 | 3    | 29,50    | 125x50x20,0     | 780,16   | 65x25        | 294,71 |  |
| M 36x3,00 | 2    | 33,00    | 125x33x22,0     | 1.426,26 | 65x25        | 346,56 |  |
| M 36x4,00 | 3    | 32,00    | 150x53x22,0     | 1.004,41 | 65x25        | 300,47 |  |
| M 39x3,00 | 2    | 36,00    | 125x33x24,0     | 1.233,12 | 75x30        | 542,91 |  |
| M 39x4,00 | 3    | 35,00    | 150x53x24,0     | 1.123,87 | 75x30        | 457,02 |  |

Other dimensions are available on request

**METRIC THREAD LEFT AND RIGHT TURNING TAP NUMBER 3**

**M**  
**MF**

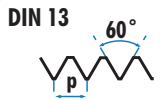

**HSS**

**DIN**  
**352**

**TOL**  
**6H**

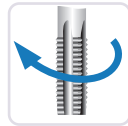
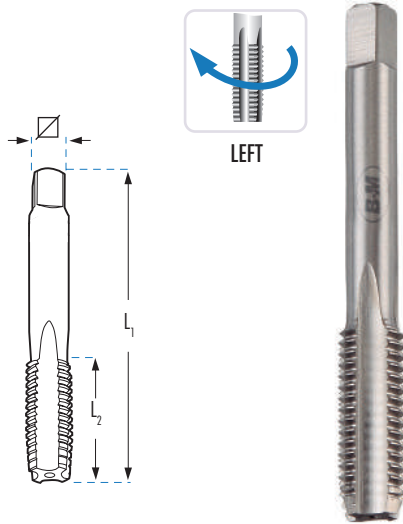

**LEFT**

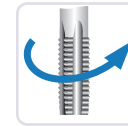

**RIGHT**

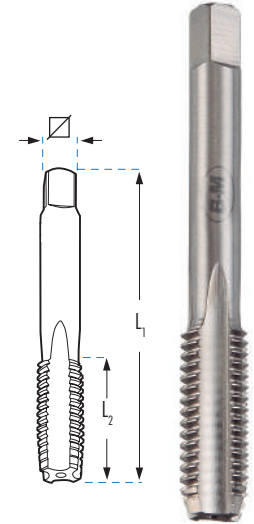

**D**  
**REDUCED**  
**SHANK**

**DIN**  
**352**

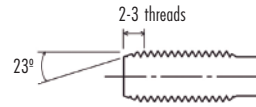

Ref. M03: Entry taper 2-3 threads.

|           |       |  |  | <b>M03I</b> |
|-----------|-------|--|--|-------------|
|           |       | $L1 \times L2 \times D2 \times \nabla$<br>mm |  | €           |
| M 3x0,50  | 2,50  | D 40 x 11 x 3,50 x 2,70                      |  | 15,16       |
| M 4x0,70  | 3,30  | D 45 x 13 x 4,50 x 3,40                      |  | 15,15       |
| M 5x0,80  | 4,20  | D 50 x 16 x 6,00 x 4,90                      |  | 16,19       |
| M 6x1,00  | 5,00  | D 50 x 19 x 6,00 x 4,90                      |  | 16,19       |
| M 7x1,00  | 6,00  | D 50 x 19 x 6,00 x 4,90                      |  | 19,73       |
| M 8x1,25  | 6,75  | D 56 x 22 x 6,00 x 4,90                      |  | 19,71       |
| M 10x1,50 | 8,50  | D 70 x 24 x 7,00 x 5,50                      |  | 24,30       |
| M 12x1,75 | 10,20 | D 75 x 29 x 9,00 x 7,00                      |  | 34,19       |
| M 14x2,00 | 12,00 | D 80 x 30 x 11,00 x 9,00                     |  | 37,82       |
| M 16x2,00 | 14,00 | D 80 x 32 x 12,00 x 9,00                     |  | 54,12       |
| M 18x2,50 | 15,50 | D 95 x 40 x 14,00 x 11,00                    |  | 71,42       |
| M 20x2,50 | 17,50 | D 95 x 40 x 16,00 x 12,00                    |  | 80,12       |

Other dimensions are available on request

|           |       |  |  | <b>M03</b> |
|-----------|-------|--|--|------------|
|           |       | $L1 \times L2 \times D2 \times \nabla$<br>mm |  | €          |
| M 3x0,50  | 2,50  | D 40 x 11 x 3,50 x 2,70                      |  | 7,58       |
| M 4x0,70  | 3,30  | D 45 x 13 x 4,50 x 3,40                      |  | 7,57       |
| M 5x0,80  | 4,20  | D 50 x 16 x 6,00 x 4,90                      |  | 8,10       |
| M 6x1,00  | 5,00  | D 50 x 19 x 6,00 x 4,90                      |  | 8,10       |
| M 7x1,00  | 6,00  | D 50 x 19 x 6,00 x 4,90                      |  | 9,86       |
| M 8x1,00  | 7,00  | D 56 x 18 x 6,00 x 4,90                      |  | 13,65      |
| M 8x1,25  | 6,75  | D 56 x 22 x 6,00 x 4,90                      |  | 9,85       |
| M 9x1,25  | 7,75  | D 63 x 18 x 7,00 x 5,50                      |  | 16,14      |
| M 10x1,00 | 9,00  | D 63 x 18 x 7,00 x 5,50                      |  | 14,62      |
| M 10x1,25 | 8,80  | D 70 x 24 x 7,00 x 5,50                      |  | 14,82      |
| M 10x1,50 | 8,50  | D 70 x 24 x 7,00 x 5,50                      |  | 12,15      |
| M 12x1,00 | 11,00 | D 70 x 20 x 9,00 x 7,00                      |  | 25,91      |
| M 12x1,25 | 10,75 | D 70 x 20 x 9,00 x 7,00                      |  | 25,84      |
| M 12x1,50 | 10,50 | D 70 x 20 x 9,00 x 7,00                      |  | 22,02      |
| M 12x1,75 | 10,20 | D 75 x 29 x 9,00 x 7,00                      |  | 17,09      |
| M 14x1,00 | 13,00 | D 70 x 20 x 11,00 x 9,00                     |  | 40,39      |
| M 14x1,25 | 12,80 | D 70 x 20 x 11,00 x 9,00                     |  | 31,55      |
| M 14x1,50 | 12,50 | D 70 x 20 x 11,00 x 9,00                     |  | 24,53      |
| M 14x2,00 | 12,00 | D 80 x 30 x 11,00 x 9,00                     |  | 18,91      |
| M 16x1,00 | 15,00 | D 70 x 20 x 12,00 x 9,00                     |  | 53,58      |
| M 16x1,25 | 14,75 | D 70 x 20 x 12,00 x 9,00                     |  | 56,40      |
| M 16x1,50 | 14,50 | D 70 x 20 x 12,00 x 9,00                     |  | 30,53      |
| M 16x2,00 | 14,00 | D 80 x 32 x 12,00 x 9,00                     |  | 27,06      |
| M 18x1,50 | 16,50 | D 80 x 22 x 14,00 x 11,00                    |  | 40,22      |
| M 18x2,50 | 15,50 | D 95 x 40 x 14,00 x 11,00                    |  | 35,71      |
| M 20x1,50 | 18,50 | D 80 x 22 x 16,00 x 12,00                    |  | 50,37      |
| M 20x2,50 | 17,50 | D 95 x 40 x 16,00 x 12,00                    |  | 40,06      |
| M 22x2,50 | 19,50 | D 100 x 40 x 18,00 x 14,50                   |  | 53,36      |
| M 24x3,00 | 21,00 | D 110 x 50 x 18,00 x 14,50                   |  | 63,65      |
| M 27x3,00 | 24,00 | D 110 x 50 x 20,00 x 16,00                   |  | 80,48      |
| M 30x3,50 | 26,50 | D 125 x 50 x 22,00 x 18,00                   |  | 103,55     |

## THREAD PITCH GAUGES



| GAM  | THREAD TYPE     | THREAD RANGE |          | GAM   |
|------|-----------------|--------------|----------|-------|
|      |                 | Metric       | Empire   | €     |
| GAM  | Metric          | 0,25 - 2,5   |          | 12,27 |
| GAMW | Metric / Empire | 0,25 - 6,0   | 62h - 4h | 22,23 |

## SET OF GUIDES FOR DIES M3-M12

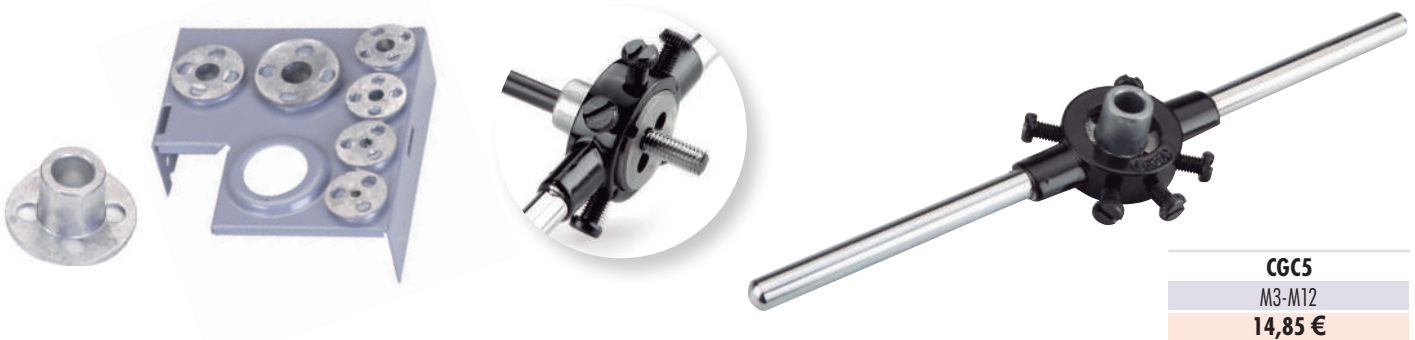

CGC5  
M3-M12  
14,85 €

## TAP EXTENSION

DIN  
377

DIN 10

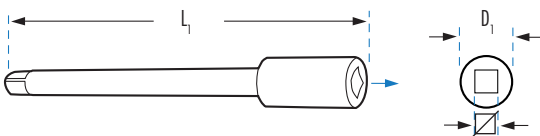

Same square dimensions in both male and female areas.

|      | ∅ x L1<br>mm | D1<br>mm | AL<br>€ |
|------|--------------|----------|---------|
| AL21 | 2,1 x 60     | 6,0      | 8,89    |
| AL24 | 2,4 x 70     | 6,0      | 8,89    |
| AL27 | 2,7 x 80     | 7,0      | 8,89    |
| AL30 | 3,0 x 90     | 7,0      | 8,89    |
| AL34 | 3,4 x 95     | 8,0      | 9,64    |
| AL38 | 3,8 x 95     | 9,0      | 10,06   |
| AL43 | 4,3 x 105    | 10,0     | 11,21   |
| AL49 | 4,9 x 110    | 11,0     | 11,22   |
| AL55 | 5,5 x 115    | 12,0     | 11,29   |
| AL62 | 6,2 x 120    | 14,0     | 13,75   |
| AL70 | 7,0 x 125    | 15,0     | 14,33   |
| AL80 | 8,0 x 125    | 17,0     | 17,89   |
| AL90 | 9,0 x 135    | 19,0     | 18,38   |

|       | ∅ x L1<br>mm | D1<br>mm | AL<br>€ |
|-------|--------------|----------|---------|
| AL100 | 10,0 x 140   | 21,0     | 25,39   |
| AL110 | 11,0 x 150   | 23,0     | 25,74   |
| AL120 | 12,0 x 160   | 25,0     | 27,72   |
| AL130 | 13,0 x 165   | 27,0     | 43,36   |
| AL145 | 14,5 x 175   | 29,0     | 43,97   |
| AL160 | 16,0 x 185   | 30,0     | 46,53   |
| AL180 | 18,0 x 195   | 33,0     | 53,01   |
| AL200 | 20,0 x 220   | 36,0     | 70,71   |
| AL220 | 22,0 x 220   | 40,0     | 103,34  |
| AL240 | 24,0 x 235   | 42,0     | 158,27  |
| AL260 | 26,0 x 245   | 45,0     | 167,12  |
| AL290 | 29,0 x 260   | 55,0     | 192,82  |
| AL320 | 32,0 x 280   | 55,0     | 237,36  |

Maximum  
Performance  
150 kg/mm<sup>2</sup>

**DROP FORGED TAP HOLDERS**

Ref. GAPRO

- Drop Forged Steel body.
- Tensile Strength up to 150 Kg/mm<sup>2</sup>.
- Maximum performance and lifetime.

- Accurate and tight tap holding.
- Adjusted and reinforced thread provides robust tool.
- Anti slip handle for a smooth grip.



**GAPRO**

| NORM N° | N° 0               | N° 1                | N° 1.1/2            | N° 2                | N° 3                 | N° 4                 | N° 5                 |
|---------|--------------------|---------------------|---------------------|---------------------|----------------------|----------------------|----------------------|
|         | M1-M8<br>2,00-5,00 | M1-M10<br>2,00-6,30 | M1-M12<br>2,50-7,00 | M1-M12<br>2,50-8,00 | M5-M20<br>4,00-13,00 | M5-M27<br>4,00-16,00 | M9-M32<br>5,50-20,00 |
| €       | 22,05              | 23,30               | 24,76               | 31,29               | 44,28                | 70,80                | 149,85               |

Ref. GA

- Zinc Alloy Body.
- High performance and lifetime.
- Accurate and precise grip.



**GA**

| NORM N° | N° 0               | N° 1                | N° 1.1/2            | N° 2                 | N° 3                 | N° 4                 | N° 5                  | N° 7                   | N° 8                   |
|---------|--------------------|---------------------|---------------------|----------------------|----------------------|----------------------|-----------------------|------------------------|------------------------|
|         | M1-M8<br>1,50-5,00 | M1-M10<br>2,00-7,00 | M1-M12<br>2,00-8,00 | M4-M12<br>2,50-10,00 | M5-M20<br>3,50-14,00 | M9-M27<br>4,00-15,00 | M13-M32<br>5,50-19,00 | M22-M52<br>14,00-34,00 | M33-M64<br>16,00-40,00 |
| €       | 18,53              | 19,59               | 20,81               | 26,29                | 37,20                | 59,50                | 125,93                | 248,77                 | 406,43                 |

**DIE HOLDERS WITH 5 AND 3 SCREWS**

Ref. VA

**DIN  
225**



5

IMPORTANT: When placing an order, please use the thicknesses mentioned below

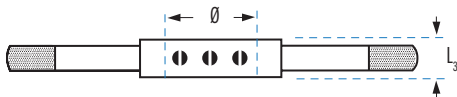

| Ø x L3 mm | 16x5   | 20x5   | 20x7   | 25x9   | 30x11  | 38x10  | 38x14  | 45x14  | 45x18  | 55x16  | 55x22 | 65x18 | VA<br>65x25 |
|-----------|--------|--------|--------|--------|--------|--------|--------|--------|--------|--------|-------|-------|-------------|
| €         | 10,29  | 11,39  | 11,39  | 13,00  | 15,75  | 20,59  | 20,56  | 25,28  | 25,46  | 32,67  | 34,22 | 46,81 | 46,81       |
| Ø x L3 mm | 75x20  | 75x30  | 90x22  | 90x36  | 105x22 | 105x36 | 120x22 | 120x36 | 130x25 | 130x36 |       |       |             |
| €         | 106,31 | 111,28 | 134,66 | 145,08 | 200,35 | 200,35 | 521,07 | 521,07 | 541,71 | 541,71 |       |       |             |

Ref. VA

**INCHES**



3



| Ø mm   | 20,60  | 25,40 | 38,10  | 50,80 | 63,50  | 76,20  | VA<br>88,90 |
|--------|--------|-------|--------|-------|--------|--------|-------------|
| Inches | 13/16" | 1"    | 1.1/2" | 2"    | 2.1/2" | 3"     | 3.1/2"      |
| €      | 13,54  | 16,06 | 24,04  | 35,65 | 56,26  | 104,04 | 131,79      |

NOTE: Die holders with imperial exterior Ø are now obsolete

## "T" TAP WRENCHES WITH RATCHET

Ref. TC

TYPE  
T

SHORT SERIES



|      | CAPACITY<br>mm<br>min.-max. | For tap shanks |         | L1<br>mm | WEIGHT<br>g | QUALITY                 | TC    |
|------|-----------------------------|----------------|---------|----------|-------------|-------------------------|-------|
|      |                             | DIN            | ISO     |          |             |                         | €     |
| TC3B | 2,6 - 5,5                   | M3 - 8         | M3 - 6  | 85       | 180         | 1 <sup>st</sup> Quality | 30,26 |
| TC4B | 4,6 - 8,0                   | M5 - 12        | M6 - 12 | 110      | 300         | 1 <sup>st</sup> Quality | 40,89 |
| TC1B | 2,6 - 5,5                   | M3 - 8         | M3 - 6  | 85       | 180         | 2 <sup>nd</sup> Quality | 22,92 |
| TC2B | 4,6 - 8,0                   | M5 - 12        | M6 - 12 | 110      | 300         | 2 <sup>nd</sup> Quality | 30,74 |

Ref. TL

TYPE  
T

LONG SERIES



|     | CAPACITY<br>mm<br>min.-max. | For tap shanks |         | L1<br>mm | WEIGHT<br>g | QUALITY                 | TL    |
|-----|-----------------------------|----------------|---------|----------|-------------|-------------------------|-------|
|     |                             | DIN            | ISO     |          |             |                         | €     |
| TL3 | 2,6 - 5,5                   | M3 - 8         | M3 - 6  | 250      | 250         | 1 <sup>st</sup> Quality | 46,03 |
| TL4 | 4,6 - 8,0                   | M5 - 12        | M6 - 12 | 300      | 440         | 1 <sup>st</sup> Quality | 54,80 |
| TL1 | 2,6 - 5,5                   | M3 - 10        | M3 - 6  | 250      | 250         | 2 <sup>nd</sup> Quality | 36,35 |
| TL2 | 4,6 - 8,0                   | M5 - 12        | M6 - 12 | 300      | 440         | 2 <sup>nd</sup> Quality | 43,31 |

## METHACRYLATE DISPLAYS

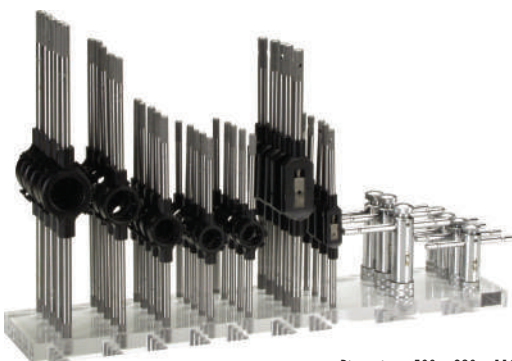

Dimensions: 500 x 320 x 110 mm

|       |               |           |   | GV-01              |        |
|-------|---------------|-----------|---|--------------------|--------|
|       |               |           |   | €                  |        |
|       |               |           |   |                    |        |
| GV-01 | N° 1 1/2<br>5 | N° 2<br>5 | 20 x 5   20 x 7   25 x 9<br>5   5   5<br>30 x 11   38 x 14<br>5   5 | TC1   TC2<br>4   4 | 797,07 |

**HAND TAPS AND DIES IN METAL CASE**



**M3  
M12**

**HSS**



Ref. D624

**CONTENT**

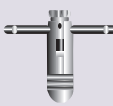
|      |  |  |  |  | No. Items | 1st Quality<br>€ | * 2nd Quality<br>€ |
|------|---|---|--|---|-----------|------------------|--------------------|
| D624 | M3 - M4 - M5 - M6 - M8 - M10 - M12  | Nº 1.1/2  | 25 x 9   | -   | 30        | <b>258,27</b>    | <b>234,29</b>      |

**HSS DIES IN METAL CASE**



**M3  
M12**

**HSS**



Ref. D671

**CONTENT**

|  |  |  | No. Items         | 1st Quality<br>€ | * 2nd Quality<br>€ |               |               |
|--|---|--|-------------------|------------------|--------------------|---------------|---------------|
| D671   | M3 - M4 - M5 - M6 - M8 - M10 - M12  | 20 x 5<br>30 x 11  | 20 x 7<br>38 x 14 | 25 x 9           | 12                 | <b>254,76</b> | <b>215,79</b> |
| D6711<br>(Left hand)  | M3 - M4 - M5 - M6 - M8 - M10 - M12  | 20 x 5<br>30 x 11  | 20 x 7<br>38 x 14 | 25 x 9           | 12                 | <b>458,57</b> | <b>388,41</b> |

\* 2nd Quality: Die holder and tap holder in ZAMAK

**HSS AND HSSCo HAND TAPS AND DIES IN METAL CASES**

**M3 M12**  **HSS** **HSSCo 5%** 









Ref. D621

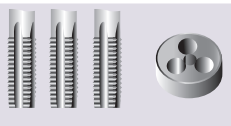

Ref. D655

**CONTENT**

|                      |  |  |  |  |  | No. Items | 1st Quality<br>€ | **2nd Quality<br>€ |
|----------------------|---|---|---|---|---|-----------|------------------|--------------------|
| D621                 | M3 - M4 - M5 - M6<br>M8 - M10 - M12   | 2.5 / 3.3 / 4.2 / 5.0<br>6.8 / 8.5 / 10.2 mm  | Nº 1<br>Nº 2  | 20 x 5 20 x 7 25 x 9<br>30 x 11 38 x 14   | TC1   | 43        | <b>517,87</b>    | <b>379,58</b>      |
| D652                 | M3 - M4 - M5 - M6<br>M8 - M10 - M12   | 2.5 / 3.3 / 4.2 / 5.0<br>6.8 / 8.5 / 10.2 mm  | Nº 1<br>Nº 2  | 20 x 5 20 x 7 25 x 9<br>30 x 11 38 x 14   | -   | 42        | <b>501,29</b>    | <b>360,46</b>      |
| D662                 | M3-M4-M5-M6-M7<br>M8-M9-M10-M11-M12   | -   | Nº 1<br>Nº 2  | 20 x 5 20 x 7 25 x 9<br>30 x 11 38 x 14   | TC1   | 48        | <b>771,48</b>    | <b>678,57</b>      |
| D651                 | M3 - M4 - M5 - M6<br>M8 - M10 - M12   | -   | Nº 1<br>Nº 2  | 20 x 5 20 x 7 25 x 9<br>30 x 11 38 x 14   | -   | 35        | <b>395,65</b>    | <b>363,99</b>      |
| D655*<br>(HSSCo)     | M3 - M4 - M5 - M6<br>M8 - M10 - M12   | 2.5 / 3.3 / 4.2 / 5.0<br>6.8 / 8.5 / 10.2 mm  | Nº 1<br>Nº 2  | 20 x 5 20 x 7 25 x 9<br>30 x 11 38 x 14   | TC1   | 43        | <b>826,14</b>    | <b>726,70</b>      |
| D621I<br>(Left hand) | M3 - M4 - M5 - M6<br>M8 - M10 - M12   | 2.5 / 3.3 / 4.2 / 5.0<br>6.8 / 8.5 / 10.2 mm  | Nº 1<br>Nº 2  | 20 x 5 20 x 7 25 x 9<br>30 x 11 38 x 14   | TC1   | 43        | <b>932,17</b>    | <b>683,24</b>      |

\* **HSSCo 5%**  

\*\* 2nd Quality: Die holder and tap holder in ZAMAK

**HSS AND HSSCo HAND TAPS AND DIES IN METAL CASES WITH GUIDES FOR DIES**

**M3  
M12**



**HSS**

**HSSCo  
5%**



Ref. D656



PILOT  
GUIDE



Ref. D657



PILOT  
GUIDE

**CONTENT**

|                  |                                     |  |              |   |               |     | No. Items | 1st Quality<br>€ | **2nd Quality<br>€ |
|------------------|-------------------------------------|--|--------------|---|---------------|-----|-----------|------------------|--------------------|
| D656             | M3 - M4 - M5 - M6<br>M8 - M10 - M12 | 2.5 / 3.3 / 4.2 / 5.0<br>6.8 / 8.5 / 10.2 mm | Nº 1<br>Nº 2 | 20 x 5   20 x 7   25 x 9<br>30 x 11   38 x 14 | + PILOT GUIDE | TC1 | 43        | <b>578,71</b>    | <b>512,29</b>      |
| D657*<br>(HSSCo) | M3 - M4 - M5 - M6<br>M8 - M10 - M12 | 2.5 / 3.3 / 4.2 / 5.0<br>6.8 / 8.5 / 10.2 mm | Nº 1<br>Nº 2 | 20 x 5   20 x 7   25 x 9<br>30 x 11   38 x 14 |               | TC1 | 43        | <b>861,50</b>    | <b>760,39</b>      |

\* **HSSCo  
5%**

\*\* 2nd Quality: Die holder and tap holder in ZAMAK

HSS AND HSSCo HAND TAPS AND DIES IN METAL CASES

M3 M20 M5 M20 HSS HSSCo 5%







Ref. D622



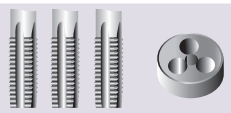

Ref. D623

CONTENT

|                   |  |  |  |  | No. Items | 1st Quality € | **2nd Quality € |
|-------------------|---|---|---|---|-----------|---------------|-----------------|
| D622 (Automotive) | M3 - M4 - M5 - M6 - M8 - M10 - M12<br>M14 - M16 - M18 - M20                         | Nº 1<br>Nº 3  | 20 x 5 20 x 7 25 x 9<br>30 x 11 38 x 14 45 x 18                                     | TC1<br>TC2  | 54        | 885,75        | 695,91          |
| D658              | M3 - M4 - M5 - M6 - M8 - M10 - M12<br>M14 - M16 - M18 - M20                         | Nº 1<br>Nº 3  | 20 x 5 20 x 7 25 x 9<br>30 x 11 38 x 14 45 x 18                                     | -   | 52        | 815,98        | 629,61          |
| D6221 (Left hand) | M3 - M4 - M5 - M6 - M8 - M10 - M12<br>M14 - M16 - M18 - M20                         | Nº 1<br>Nº 3  | 20 x 5 20 x 7 25 x 9<br>30 x 11 38 x 14 45 x 18                                     | TC1<br>TC2  | 54        | 1594,35       | 1.252,64        |
| D659* (HSSCo)     | M3 - M4 - M5 - M6 - M8 - M10 - M12<br>M14 - M16 - M18 - M20                         | Nº 1<br>Nº 3  | 20 x 5 20 x 7 25 x 9<br>30 x 11 38 x 14 45 x 18                                     | -   | 52        | 1839,88       | 1.618,36        |
| D623              | M5 - M6 - M8 - M10 - M12<br>M14 - M16 - M18 - M20                                   | Nº 1<br>Nº 3  | 20 x 7 25 x 9<br>30 x 11 38 x 14 45 x 18  | TC1<br>TC2  | 45        | 928,65        | 727,04          |
| D663              | M5 - M6 - M7 - M8 - M9 - M10 - M12<br>M14 - M16 - M18 - M20                         | Nº 1<br>Nº 3  | 20 x 7 25 x 9 30 x 11<br>38 x 14 45 x 18  | -   | 51        | 1.238,09      | 1.113,64        |

\* HSSCo 5%

\*\* 2nd Quality: Die holder and tap holder in ZAMAK

**HSS HAND TAPS AND DIES IN METAL AND WOODEN CASES**

**M1  
M10**

**M5  
M12**

**M3  
M24**

**M5  
M30**

**HSS**

Threading tools  
Green







Ref. D628

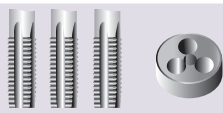

Ref. D626

**CONTENT**

|      |  |  |  |  | No. Items | 1st Quality<br>€ | * 2nd Quality<br>€ |
|------|---|---|---|---|-----------|------------------|--------------------|
| D626 | M1 - M1.2 - M1.4 - M1.7 - M2.0 - M2.3<br>M2.6 - M3 - M3.5 - M4 - M5 - M6 - M8 - M10 | Nº 0<br>Nº 1  | 16 x 5 20 x 5 20 x 7<br>25 x 9 30 x 11  | TC1   | 64        | -                | <b>1.158,45</b>    |
| D627 | M5 - M6 - M7 - M8 - M9 - M10 - M11 - M12  | Nº 1<br>Nº 2  | 20 x 7 25 x 9<br>30 x 11 38 x 14  | TC1   | 39        | -                | <b>865,42</b>      |
| D625 | M3 - M4 - M5 - M6 - M8 - M10 - M12 - M14<br>M16 - M18 - M20 - M22 - M24             | Nº 1<br>Nº 4  | 20 x 5 20 x 7 25 x 9<br>30 x 11 38 x 14 45 x 18 55 x 22                             | -   | 61        | <b>2.044,04</b>  | <b>1.508,17</b>    |
| D628 | M5 - M6 - M8 - M10 - M12 - M14 - M16<br>M18 - M20 - M22 - M24 - M27 - M30           | Nº 1<br>Nº 3<br>Nº 5  | 20 x 7 25 x 9 30 x 11<br>38 x 14 45 x 18 55 x 22<br>65 x 25                         | -   | 62        | -                | <b>2.760,51</b>    |

\* 2nd Quality: Die holder and tap holder in ZAMAK

## HSS HAND TAPS AND DIES IN METAL CASES

MF

HSS

Threading tools

Green







Ref. D634

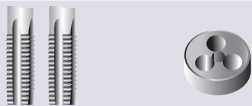

Ref. D636





## CONTENT

|      |    |  |  |  | No. Items | 1st Quality<br>€ | * 2nd Quality<br>€ |
|------|---|---|---|---|-----------|------------------|--------------------|
| D634 | MF 3 x 0.35 - 4 x 0.5 - 5 x 0.5<br>MF 6 x 0.75 - 8 x 0.75 - 8 x 1.0<br>MF 10 x 1.0 - 12 x 1.5   | N° 1<br>N° 2  | 20 x 5 25 x 9<br>30 x 11 38 x 10  | TC1   | 31        | -                | 794,00             |
| D635 | MF 6 x 0.75 - 8 x 0.75 - 8 x 1.0 - 10 x 1.0<br>MF 12 x 1.0 - 12 x 1.5 - 14 x 1.25 - 14 x 1.5<br>MF 16 x 1.5 - 18 x 1.5 - 20 x 1.5                           | N° 1<br>N° 3  | 20 x 7 25 x 9<br>30 x 11 38 x 10 45 x 14  | -   | 40        | 1.295,17         | 1.231,61           |
| D636 | MF 6 x 0.75 - 8 x 0.75 - 8 x 1.0 - 10 x 1.0<br>MF 12 x 1.0 - 12 x 1.5 - 14 x 1.25 - 14 x 1.5<br>MF 16 x 1.5 - 18 x 1.5 - 20 x 1.5 - 22 x 1.5<br>MF 24 x 1.5 | N° 1<br>N° 4  | 20 x 7 25 x 9 30 x 11<br>38 x 10 45 x 14 55 x 16                                    | -   | 47        | 1.776,74         | 1.642,72           |

\* 2nd Quality: Die holder and tap holder in ZAMAK

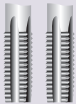



**HSS HAND TAPS AND DIES IN METAL CASES**

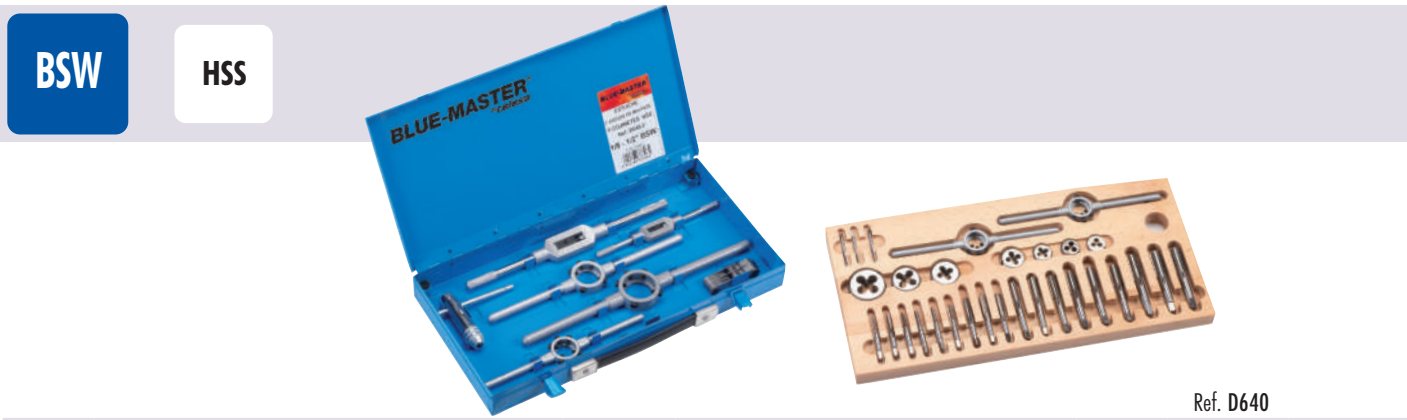

| CONTENT |   |   |   |   |   |           |                  |                    |
|---------|---|---|---|---|---|-----------|------------------|--------------------|
|         |  |  |  |  |  | No. Items | 1st Quality<br>€ | * 2nd Quality<br>€ |
| D637    | G 1/8 - 1/4 - 3/8 - 1/2 - 3/4 - 1"  |   | Nº 1<br>Nº 3<br>Nº 5  | 30 x 11 38 x 10 45 x 14<br>55 x 16 65 x 18  | -   | 26        | <b>1.438,04</b>  | <b>1.161,63</b>    |
| D638    | G 1/8 - 1/4 - 3/8 - 1/2 - 5/8 - 3/4 - 7/8 - 1"                                    |   | Nº 1<br>Nº 3<br>Nº 5  | 30 x 11 38 x 10 45 x 14<br>55 x 16 65 x 18  | -   | 32        | <b>1.951,57</b>  | <b>1.703,58</b>    |
| D639    | G 1/4 - 3/8 - 1/2 - 3/4 - 1" - 1".1/4 - 1".1/2                                    |   | Nº 2<br>Nº 4<br>Nº 7  | 38 x 10 45 x 14 55 x 16<br>65 x 18 75 x 20 90 x 22                                | -   | 30        | <b>3.600,32</b>  | <b>3.037,02</b>    |

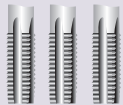
\* 2nd Quality: Die holder and tap holder in ZAMAK



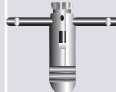

| CONTENT |  |   |   |   |   |           |                  |                    |
|---------|--|---|---|---|---|-----------|------------------|--------------------|
|         |             |  |  |  |  | No. Items | 1st Quality<br>€ | * 2nd Quality<br>€ |
| D640    | BSW 1/8 - 3/16 - 1/4 - 5/16 - 3/8 - 7/16 - 1/2   |   | Nº 1<br>Nº 2  | 20 x 5 20 x 7 25 x 9<br>30 x 11 38 x 14   | TC1   | 36        | <b>802,23</b>    | <b>685,78</b>      |
| D641    | BSW 1/4 - 5/16 - 3/8 - 7/16 - 1/2  |   | Nº 1<br>Nº 2  | 20 x 7 25 x 9<br>30 x 11 38 x 14  | TC1   | 27        | <b>661,33</b>    | <b>557,02</b>      |
| D642    | BSW 1/4 - 5/16 - 3/8 - 7/16 - 1/2 - 5/8 - 3/4  |   | Nº 1<br>Nº 3  | 20 x 7 25 x 9 30 x 11<br>38 x 14 45 x 18  | -   | 35        | <b>1.183,54</b>  | <b>1.079,93</b>    |
| D643    | BSW 1/4 - 5/16 - 3/8 - 7/16<br>1/2 - 5/8 - 3/4 - 7/8 - 1"                                      |   | Nº 1<br>Nº 4  | 20 x 7 25 x 9 30 x 11<br>38 x 14 45 x 18 55 x 22                                    | -   | 44        | <b>1.673,80</b>  | <b>1.469,54</b>    |
| D646    | BSW 1/4 - 5/16 - 3/8 - 7/16<br>1/2 - 5/8 - 3/4 - 7/8 - 1" - 1".1/8<br>1".1/4 - 1".3/8 - 1".1/2 |   | Nº 1<br>Nº 3<br>Nº 5  | 20 x 7 25 x 9 30 x 11<br>38 x 14 45 x 18 55 x 22<br>65 x 25                         | -   | 62        | -                | <b>4.465,59</b>    |

\* 2nd Quality: Die holder and tap holder in ZAMAK

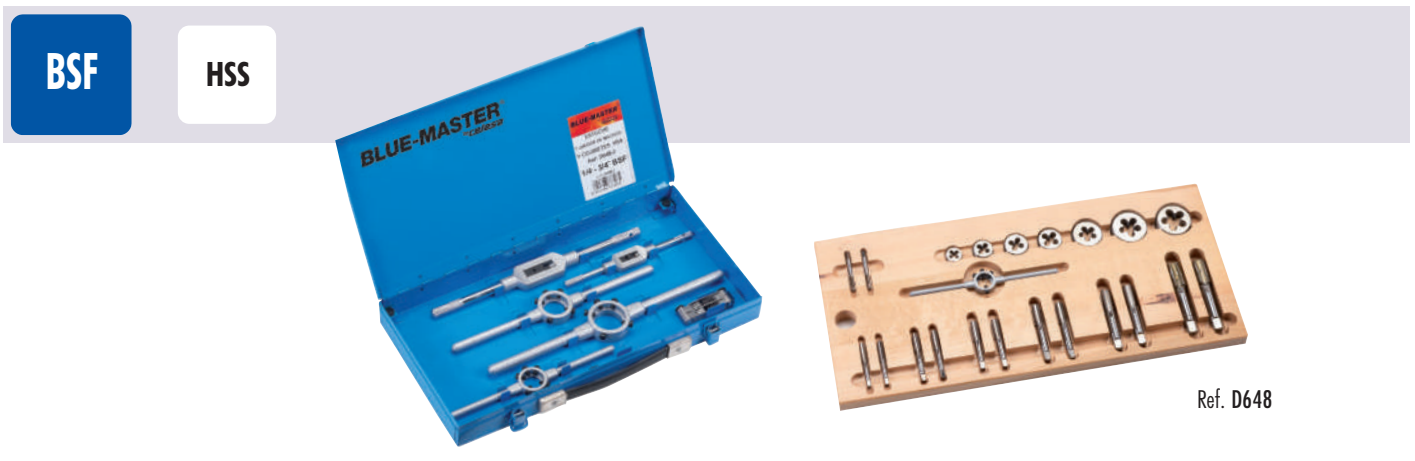
**HSS HAND TAPS AND DIES IN METAL CASES**



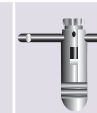

**CONTENT**

|      |  |  |  |  | No. Items | 1st Quality €   | * 2nd Quality € |
|------|---|---|---|---|-----------|-----------------|-----------------|
| D664 | BSF 1/4 - 5/16 - 3/8 - 7/16 - 1/2   | Nº 1<br>Nº 2  | 20 x 7 25 x 9<br>30 x 11 38 x 10  | TC1   | 22        | <b>739,56</b>   | <b>650,51</b>   |
| D648 | BSF 1/4 - 5/16 - 3/8 - 7/16 - 1/2 - 5/8 - 3/4                                     | Nº 1<br>Nº 3  | 20 x 7 25 x 9 30 x 11<br>38 x 10 45 x 14  | -   | 28        | <b>1.148,09</b> | <b>1.079,93</b> |
| D665 | BSF 1/4 - 5/16 - 3/8 - 7/16<br>1/2 - 5/8 - 3/4 - 7/8 - 1"                         | Nº 1<br>Nº 4  | 20 x 7 25 x 9 30 x 11<br>38 x 10 45 x 14 55 x 16                                  | -   | 35        | <b>1.948,12</b> | <b>1.713,55</b> |

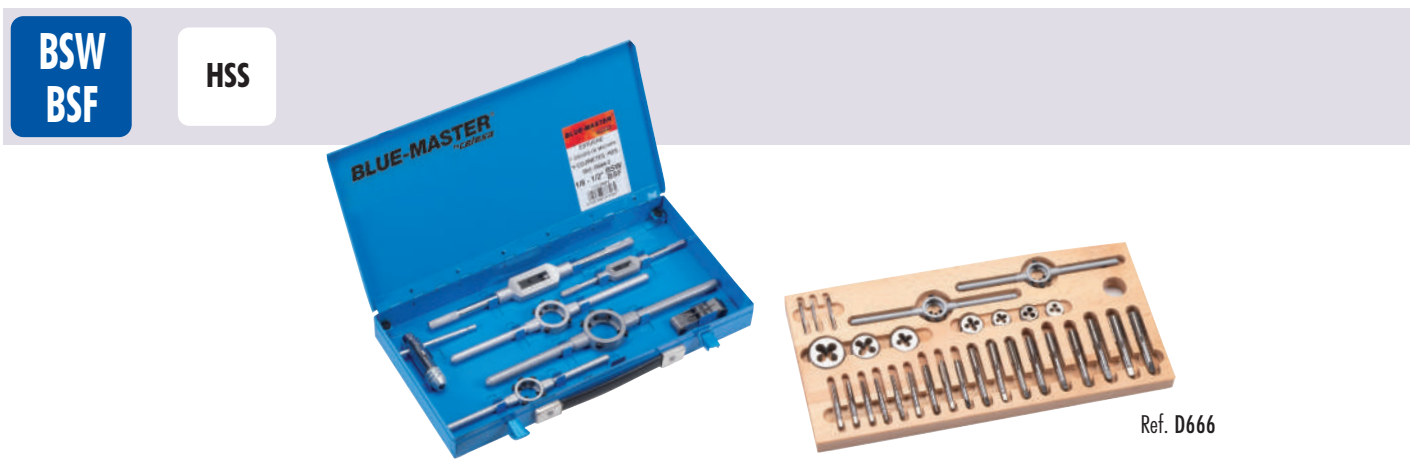
\* 2nd Quality: Die holder and tap holder in ZAMAK

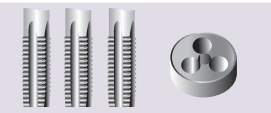

**CONTENT**

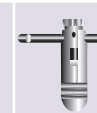
|      |             |  |  |  | No. Items | 1st Quality €   | * 2nd Quality € |
|------|--|---|---|---|-----------|-----------------|-----------------|
| D666 | BSW 1/4 - 5/16 - 3/8 - 7/16 - 1/2 - 5/8 - 3/4<br>BSF 1/4 - 5/16 - 3/8 - 7/16 - 1/2 - 5/8 - 3/4 | Nº 1<br>Nº 3  | 20 x 7 25 x 9 30 x 11<br>38 x 14 45 x 18  | -   | 63        | <b>2.200,66</b> | <b>1.935,68</b> |

\* 2nd Quality: Die holder and tap holder in ZAMAK





**HSS HAND TAPS AND DIES IN METAL CASES**

**NPT** **HSS**



Ref. D660

**CONTENT**

|      |  |  |  |  |  | No. Items | 1st Quality<br>€ | * 2nd Quality<br>€ |
|------|---|---|---|---|---|-----------|------------------|--------------------|
| D660 | NPT 1/8 - 1/4 - 3/8 - 1/2 - 3/4 - 1"  |   | Nº1<br>Nº3<br>Nº5   | 30 x 11 38 x 14 45 x 18 55 x 22<br>65 x 25  | -   | 20        | <b>2.080,19</b>  | <b>1.973,16</b>    |
| D661 | NPT 1/8 - 1/4 - 3/8 - 1/2 - 3/4<br>1" - 1.1/4 - 1.1/2 - 2"                        |   | Nº 2<br>Nº 4<br>Nº 7  | 30 x 11 38 x 14 45 x 18 55 x 22<br>65 x 25 75 x 30 90 x 36 105 x 36               | -   | 29        | <b>6.227,02</b>  | <b>5.850,26</b>    |





\* 2nd Quality: Die holder and tap holder in ZAMAK

**UNC** **HSS**

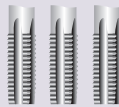

Ref. D650

**CONTENT**

|      |         |  |  |  |  | No. Items | 1st Quality<br>€ | * 2nd Quality<br>€ |
|------|--|---|---|---|---|-----------|------------------|--------------------|
| D650 | UNC 1/4 - 5/16 - 3/8 - 7/16 - 1/2  |   | Nº 1<br>Nº 2  | 20 x 7 25 x 9<br>30 x 11 38 x 14  | TC1   | 27        | <b>806,09</b>    | <b>723,50</b>      |
| D667 | UNC 1/4 - 5/16 - 3/8 - 7/16 - 1/2 - 5/8 - 3/4  |   | Nº 1<br>Nº 2  | 20 x 7 25 x 9 30 x 11<br>38 x 14 45 x 18  | -   | 35        | <b>1.298,75</b>  | <b>1.142,36</b>    |
| D654 | UNC 1/4 - 5/16 - 3/8 - 7/16<br>1/2 - 5/8 - 3/4 - 7/8 - 1"                                  |   | Nº 1<br>Nº 4  | 20 x 7 25 x 9 30 x 11<br>38 x 14 45 x 18 55 x 22                                    | -   | 44        | <b>2.095,65</b>  | <b>1.961,26</b>    |
| D668 | UNC 1/4 - 5/16 - 3/8 - 7/16 - 1/2 - 5/8 - 3/4<br>7/8 - 1" - 1.1/8 - 1.1/4 - 1.3/8 - 1.1/2" |   | Nº 1<br>Nº 3<br>Nº 6  | 20 x 7 25 x 9 30 x 11<br>38 x 14 45 x 18 55 x 22<br>65 x 25                         | -   | 62        | <b>4.906,35</b>  | <b>4.315,59</b>    |

\* 2nd Quality: Die holder and tap holder in ZAMAK

## HSS HAND TAPS AND DIES IN METAL CASES





UNF

HSS

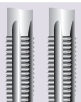

Ref. D644

## CONTENT

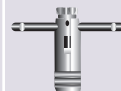
|      |  |  |  |  |  | No. Items | 1st Quality<br>€ | * 2nd Quality<br>€ |
|------|---|---|---|---|---|-----------|------------------|--------------------|
| D644 | UNF 1/4 - 5/16 - 3/8 - 7/16 - 1/2   |   | Nº 1<br>Nº 2  | 20 x 7 25 x 9<br>30 x 11 38 x 10  | TC1   | 22        | 631,65           | 547,58             |
| D669 | UNF 1/4-5/16 -3/8 -7/16 -1/2 -5/8 -3/4  |   | Nº 1<br>Nº 3  | 20 x 7 25 x 9 30 x 11<br>38 x 10 45 x 14  | -   | 28        | 1.190,50         | 1.047,16           |
| D645 | UNF 1/4 - 5/16 - 3/8 - 7/16 - 1/2 - 5/8<br>3/4 - 7/8 - 1"                         |   | Nº 1<br>Nº 4  | 20 x 7 25 x 9 30 x 11<br>38 x 10 45 x 14 55 x 16                                  | -   | 34        | 1.459,80         | 1.323,60           |

\* 2nd Quality: Die holder and tap holder in ZAMAK



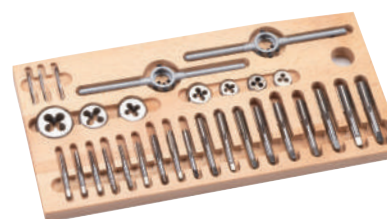

UNC  
UNF

HSS

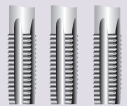

Ref. D670

## CONTENT

|      |             |  |  |  |  | No. Items | 1st Quality<br>€ | * 2nd Quality<br>€ |
|------|--|---|---|---|---|-----------|------------------|--------------------|
| D670 | UNC 1/4 - 5/16 - 3/8 - 7/16 - 1/2 - 5/8 - 3/4<br>UNF 1/4 - 5/16 - 3/8 - 7/16 - 1/2 - 5/8 - 3/4 |   | Nº 1<br>Nº 3  | 20 x 7 25 x 9 30 x 11<br>38 x 14 45 x 18  | -   | 35        | 2.200,66         | 1.935,68           |

\* 2nd Quality: Die holder and tap holder in ZAMAK

**HSS & TIN COATED HAND TAPS SETS IN METAL BOXES**



Ref. JMB0



Ref. JMB2



Ref. JMBT2

**CONTENT**

|                      |                                     |  |          |     | HSS    |        | TiN*   |
|----------------------|-------------------------------------|--|----------|-----|--------|--------|--------|
|                      |                                     |  |          |     | €      |        | €      |
| JMB2                 | M3 - M4 - M5 - M6<br>M8 - M10 - M12 | -  | -        | -   | 204,49 | JMBT2  | 406,02 |
| JMB0                 | M3 - M4 - M5 - M6<br>M8 - M10 - M12 | 2.5 / 3.3 / 4.2 / 5.0<br>6.8 / 8.5 / 10.2 mm | -        | -   | 233,25 | JMBT0  | 455,63 |
| JMB1                 | M3 - M4 - M5 - M6<br>M8 - M10 - M12 | 2.5 / 3.3 / 4.2 / 5.0<br>6.8 / 8.5 / 10.2 mm | Nº 1.1/2 | -   | 251,04 | JMBT1  | 390,43 |
| JMB5                 | M3 - M4 - M5 - M6<br>M8 - M10 - M12 | 2.5 / 3.3 / 4.2 / 5.0<br>6.8 / 8.5 / 10.2 mm | Nº 1.1/2 | TC1 | 266,64 | JMBT5  | 409,11 |
| JMBI2<br>(Left hand) | M3 - M4 - M5 - M6<br>M8 - M10 - M12 | -  | -        | -   | 368,07 | JMBIT2 | 730,83 |
| JMBI0<br>(Left hand) | M3 - M4 - M5 - M6<br>M8 - M10 - M12 | 2.5 / 3.3 / 4.2 / 5.0<br>6.8 / 8.5 / 10.2 mm | -        | -   | 419,86 | JMBIT0 | 820,14 |
| JMBI1<br>(Left hand) | M3 - M4 - M5 - M6<br>M8 - M10 - M12 | 2.5 / 3.3 / 4.2 / 5.0<br>6.8 / 8.5 / 10.2 mm | Nº 1.1/2 | -   | 451,88 | JMBIT1 | 702,78 |

**HSS AND TIN COATED BOTTOMING TAPS IN METAL BOXES**



Ref. JMB3



Ref. JMB4

**CONTENT**

| <b>3°</b>            |                                     |  |          |     | HSS    |        | TiN*   |
|----------------------|-------------------------------------|--|----------|-----|--------|--------|--------|
|                      |                                     |  |          |     | €      |        | €      |
| JMB3                 | M3 - M4 - M5 - M6<br>M8 - M10 - M12 | -  | -        | -   | 93,87  | JMBT3  | 117,55 |
| JMB4                 | M3 - M4 - M5 - M6<br>M8 - M10 - M12 | 2.5 / 3.3 / 4.2 / 5.0<br>6.8 / 8.5 / 10.2 mm | -        | -   | 116,83 | JMBT4  | 155,29 |
| JMB7                 | M3 - M4 - M5 - M6<br>M8 - M10 - M12 | 2.5 / 3.3 / 4.2 / 5.0<br>6.8 / 8.5 / 10.2 mm | Nº 1.1/2 | -   | 133,69 | JMBT7  | 215,41 |
| JMB6                 | M3 - M4 - M5 - M6<br>M8 - M10 - M12 | 2.5 / 3.3 / 4.2 / 5.0<br>6.8 / 8.5 / 10.2 mm | Nº 1.1/2 | TC1 | 144,77 | JMBT6  | 229,60 |
| JMBI3<br>(Left hand) | M3 - M4 - M5 - M6<br>M8 - M10 - M12 | -  | -        | -   | 168,97 | JMBIT3 | 211,60 |
| JMBI4<br>(Left hand) | M3 - M4 - M5 - M6<br>M8 - M10 - M12 | 2.5 / 3.3 / 4.2 / 5.0<br>6.8 / 8.5 / 10.2 mm | -        | -   | 210,30 | JMBIT4 | 279,53 |



## HSSCo HAND TAPS IN METAL BOXES



HSSCo  
5%

Ref. JMBX0

## CONTENT

| INOX  |  MOX |  HSSCo |  |  | €      |
|-------|---|---|--|---|--------|
| JMBX0 | M3 - M4 - M5 - M6<br>M8 - M10 - M12   | 2.5 / 3.3 / 4.2 / 5.0<br>6.8 / 8.5 / 10.2 mm  | -  | -   | 322,33 |
| JMBX1 | M3 - M4 - M5 - M6<br>M8 - M10 - M12   | 2.5 / 3.3 / 4.2 / 5.0<br>6.8 / 8.5 / 10.2 mm  | Nº 1.1/2   | -   | 339,23 |
| JMBX2 | M3 - M4 - M5 - M6<br>M8 - M10 - M12   | -   | -  | -   | 304,80 |

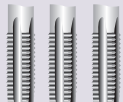
## CONTENT

| 1100<br>N/mm <sup>2</sup> |  MOMD |  HSSCo |  |  | €      |
|---------------------------|--|---|--|---|--------|
| JMBMD0                    | M3 - M4 - M5 - M6<br>M8 - M10 - M12  | 2.5 / 3.3 / 4.2 / 5.0<br>6.8 / 8.5 / 10.2 mm  | -  | -   | 336,62 |
| JMBMD1                    | M3 - M4 - M5 - M6<br>M8 - M10 - M12  | 2.5 / 3.3 / 4.2 / 5.0<br>6.8 / 8.5 / 10.2 mm  | Nº 1.1/2   | -   | 354,13 |
| JMBMD2                    | M3 - M4 - M5 - M6<br>M8 - M10 - M12  | -   | -  | -   | 320,88 |

## HSS DIES IN METAL BOXES



Ref. C5B3



## CONTENT

|                      |  | HSS<br>€ |
|----------------------|--|----------|
| C5B3                 | M3 - M4 - M5 - M6 - M8 - M10 - M12   | 244,31   |
| C5B3I<br>(Left hand) | M3 - M4 - M5 - M6 - M8 - M10 - M12   | 439,75   |

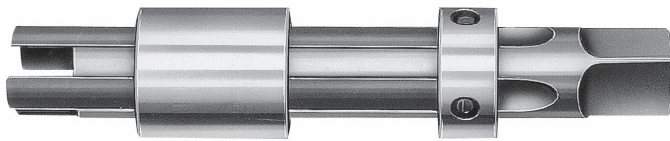

**BROKEN TAP EXTRACTOR FOR STRAIGHT FLUTE TAPS (WITHOUT HELIX)**



**SINGLE EXTRACTORS**

| TAP EXTRACTOR SIZE Ø |      | HAND TAPS   | MACHINE TAPS  | €/ Unit            |
|----------------------|------|---|---|--------------------|
| BSW UNC              | M    |  |  | COMPLETE EXTRACTOR |
| --                   | M3   |   | W10043  | 46,59              |
| 1/8                  | M3,2 |   | W10053  | 46,59              |
| --                   | M3,5 |   | W10063  | 46,59              |
| 5/32                 | M4   |   | W10083  | 46,59              |
| 3/16                 | M5   |   | W10103  | 46,59              |
| --                   | M5,5 | W10124  | W10123  | 46,59              |
| 1/4                  | M6   |   | W10253  | 47,96              |
| 5/16                 | M8   | W10314  | W10313  | 50,25              |
| --                   | M9   | W10374  | W10373  | 49,78              |
| 3/8                  | M10  | W10404  | W10373  | 49,78              |
| 7/16                 | M11  | W10434  | W10433  | 52,55              |
| 1/2                  | M12  | W10504  | W10503  | 56,19              |
| 9/16                 | M14  | W10564  | W10563  | 77,65              |
| 5/8                  | M16  | W10624  | W10623  | 84,51              |
| --                   | M18  | W10684  | W10753  | 104,71             |
| 3/4                  | M20  | W10754  | W10753  | 104,71             |
| 7/8                  | M22  | W10874  | W10873  | 114,58             |
| 1"                   | M25  | W11004  | W11003  | 127,77             |

**SPARE HOLDER**

| HAND TAPS   | MACHINE TAPS  | €/ Unit      |
|---|---|--------------|
|  |  | EXTRA HOLDER |
|   | W12043  | 2,48         |
|   | W12053  | 2,48         |
|   | W12063  | 2,48         |
|   | W12083  | 2,48         |
|   | W12103  | 3,70         |
|   | W12123  | 3,70         |
|   | W12253  | 4,51         |
| W12314  | W12313  | 5,09         |
| W12374  |   | 5,09         |
| W12404  | W12373  | 5,25         |
| W12434  | W12433  | 5,34         |
| W12504  | W12503  | 6,72         |
| W12564  | W12563  | 7,49         |
| W12624  | W12623  | 9,58         |
| W12684  |   | 9,58         |
| W12754  | W12753  | 10,14        |
| W12874  | W12873  | 13,13        |
| W13004  | W13003  | 21,86        |

**3 SIMPLE STEPS FOR REMOVING BROKEN TAPS WITH STRAIGHT FLUTES**

Thoroughly remove all chips of the broken tap. Insert the extractors fingers into the flutes of the broken tap, pushing them gently but firmly into position.

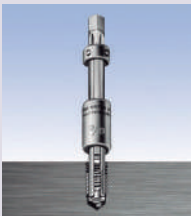

Push the holder down until it touches the broken tap. Slide the sleeve down until it touches the work piece.



Apply a tap wrench to the square end of the holder. Twist forward & backwards a few times to loosen, then back out the broken tap.



**BROKEN TAP EXTRACTORS SETS FOR STRAIGHT FLUTES TAPS**



|         | NUMBER OF FLUTES | SIZES INCLUDED FOR MACHINE & HAND TAPS: 3 AND 4 FLUTES |          |
|---------|------------------|--|----------|
| W180013 | 3                | M5- M6- M8- M10- M11- M12                              | 322,98   |
| W180014 | 4                | 3/16 - 1/4 - 5/16 - 3/8 - 7/16 - 1/2                   |          |
| W180023 | 3                | M6- M8 -M10- M11- M12- M16                             | 363,37   |
| W180024 | 4                | 1/4 - 5/16 - 3/8 - 7/16 - 1/2 - 5/8                    |          |
| W180153 | 3                | M3- M3,2- M3,5- M4-M5- M5,50- M6- M8                   | 1.016,43 |
| W180154 | 4                | M9- M10- M12- M16- M18- M22- M25                       |          |

## HSSCo MACHINE TAPS

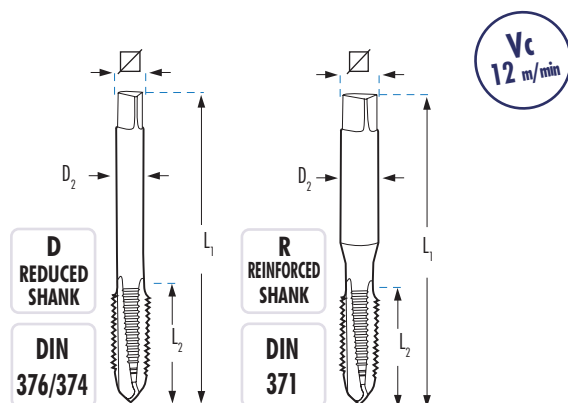
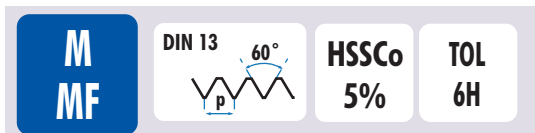



| D          | Ø    | L1 x L2 x D2 x $\nabla$<br>mm                  | M1D    |        | M2D    |        | M3D |     | M4D    |        | M1R    |        | M2R    |        | M3R   |     | M4R |       |
|------------|------|--|--------|--------|--------|--------|-----|-----|--------|--------|--------|--------|--------|--------|-------|-----|-----|-------|
|            |      |  | C FORM | B FORM | C FORM | B FORM | 15° | 35° | C FORM | B FORM | 15°    | 35°    | C FORM | B FORM | 15°   | 35° | €   | €     |
| €          | €    | €  | €      | €      | €      | €      | €   | €   | €      | €      | €      | €      | €      | €      | €     | €   | €   | €     |
| M 1x0,25   | 0,75 | R 40 x 5,5 x 2,5 x 2,1                         |        |        |        |        |     |     |        |        |        | 45,51  |        |        |       |     |     |       |
| M 1,1x0,25 | 0,85 | R 40 x 6 x 2,5 x 2,1                           |        |        |        |        |     |     |        |        |        | 44,27  |        |        |       |     |     |       |
| M 1,2x0,25 | 0,95 | R 40 x 6 x 2,5 x 2,1                           |        |        |        |        |     |     |        |        |        | 40,44  |        |        |       |     |     |       |
| M 1,4x0,30 | 1,10 | R 40 x 7 x 2,5 x 2,1                           |        |        |        |        |     |     |        |        |        | 40,44  |        |        |       |     |     |       |
| M 1,6x0,35 | 1,25 | R 40 x 8 x 2,5 x 2,1                           |        |        |        |        |     |     |        |        |        | 39,71  |        |        |       |     |     |       |
| M 1,7x0,35 | 1,35 | R 40 x 8 x 2,5 x 2,1                           |        |        |        |        |     |     |        |        |        | 38,24  |        |        |       |     |     |       |
| M 1,8x0,35 | 1,45 | R 40 x 8 x 2,5 x 2,1                           |        |        |        |        |     |     |        |        |        | 37,30  |        |        |       |     |     |       |
| M 2x0,40   | 1,60 | R 40 x 8 x 2,8 x 2,1                           |        |        |        |        |     |     |        |        |        | 17,96  | 19,90  | 22,25  | 22,67 |     |     |       |
| M 2,2x0,45 | 1,75 | R 40 x 9 x 2,8 x 2,1                           |        |        |        |        |     |     |        |        |        | 19,41  |        |        |       |     |     |       |
| M 2,3x0,40 | 1,90 | R 40 x 9 x 2,8 x 2,1                           |        |        |        |        |     |     |        |        |        | 17,88  |        |        |       |     |     |       |
| M 2,5x0,45 | 2,05 | R 50 x 9 x 2,8 x 2,1                           |        |        |        |        |     |     |        |        |        | 17,96  | 19,90  | 31,28  | 22,67 |     |     |       |
| M 2,6x0,45 | 2,10 | R 50 x 9 x 2,8 x 2,1                           |        |        |        |        |     |     |        |        |        | 17,99  | 20,25  |        |       |     |     | 37,68 |
| M 3x0,50   | 2,50 | R 56 x 11 x 3,5 x 2,7<br>D 56 x 11 x 2,2 x 1,8 | 11,90  | 12,88  | 17,93  | 15,46  |     |     |        |        | 11,90* | 12,09  | 17,58  | 15,84  |       |     |     |       |
| M 3x0,60   | 2,40 | R 56 x 11 x 3,5 x 2,7                          |        |        |        |        |     |     |        |        |        | 21,15  | 23,08  |        |       |     |     | 30,48 |
| M 3,5x0,60 | 2,90 | R 56 x 12 x 4,0 x 3,0<br>D 56 x 12 x 2,5 x 2,1 |        |        |        |        |     |     |        |        |        | 17,29  | 18,00  | 23,25  | 21,82 |     |     |       |
| M 3,5x0,75 | 2,75 | R 56 x 12 x 4,0 x 3,0                          |        |        |        |        |     |     |        |        |        | 22,86  |        |        |       |     |     |       |
| M 4x0,50   | 3,50 | R 63 x 13 x 4,5 x 3,4<br>D 63 x 13 x 2,8 x 2,1 | 26,05  | 28,69  |        | 30,33  |     |     |        |        |        | 24,90  | 27,70  |        |       |     |     | 32,07 |
| M 4x0,70   | 3,30 | R 63 x 13 x 4,5 x 3,4<br>D 63 x 13 x 2,8 x 2,1 | 12,11  | 13,02  | 19,23  | 15,31  |     |     |        |        |        | 13,53* | 12,77  | 17,35  | 15,86 |     |     |       |
| M 4x0,75   | 3,25 | R 63 x 13 x 4,5 x 3,4                          |        |        |        |        |     |     |        |        |        | 18,93  | 20,21  |        |       |     |     |       |
| M 4x0,80   | 3,20 | R 63 x 13 x 4,5 x 3,4                          |        |        |        |        |     |     |        |        |        | 100,49 |        |        |       |     |     |       |
| M 4,5x0,50 | 4,00 | R 70 x 14 x 6,0 x 4,9                          |        |        |        |        |     |     |        |        |        |        | 32,22  |        |       |     |     |       |
| M 4,5x0,75 | 3,75 | R 70 x 14 x 6,0 x 4,9                          |        |        |        |        |     |     |        |        |        | 23,36  | 25,73  |        |       |     |     |       |
| M 5x0,50   | 4,50 | R 70 x 14 x 6,0 x 4,9<br>D 70 x 11 x 3,5 x 2,7 | 26,83  | 29,47  |        | 30,67  |     |     |        |        |        | 25,64  | 28,46  |        |       |     |     | 34,21 |
| M 5x0,75   | 4,50 | R 74 x 14 x 6,0 x 4,9<br>D 70 x 16 x 3,5 x 2,7 |        |        |        |        |     |     |        |        |        | 23,00  | 26,97  |        |       |     |     | 33,99 |
| M 5x0,80   | 4,20 | R 70 x 16 x 6,0 x 4,9<br>D 70 x 16 x 3,5 x 2,7 | 12,11  | 13,09  | 18,43  | 14,70  |     |     |        |        |        | 12,12* | 12,79  | 16,64  | 15,20 |     |     |       |
| M 5x0,90   | 4,10 | R 70 x 15 x 6,0 x 4,9<br>D 70 x 16 x 3,5 x 2,7 |        |        |        |        |     |     |        |        |        | 20,00  | 25,77  |        |       |     |     |       |
| M 5x1,00   | 4,00 | R 72 x 17 x 6,0 x 4,9                          |        |        |        |        |     |     |        |        |        | 53,57  |        |        |       |     |     |       |
| M 5,5x0,90 | 4,60 | R 80 x 17 x 6,0 x 4,9                          |        |        |        |        |     |     |        |        |        | 53,57  |        |        |       |     |     |       |
| M 6x0,50   | 5,50 | R 80 x 17 x 6,0 x 4,9<br>D 80 x 13 x 4,5 x 3,4 | 31,76  | 38,94  |        | 49,14  |     |     |        |        |        | 33,57  |        |        |       |     |     |       |
| M 6x0,75   | 5,25 | R 80 x 13 x 6,0 x 4,9<br>D 80 x 13 x 4,5 x 3,4 | 20,93  | 24,23  |        | 28,30  |     |     |        |        |        | 21,75  | 25,34  |        |       |     |     | 30,43 |
| M 6x1,00   | 5,00 | R 80 x 19 x 6,0 x 4,9<br>D 80 x 19 x 4,5 x 3,4 | 13,81  | 14,34  | 19,28  | 16,12  |     |     |        |        |        | 13,79* | 14,03  | 18,26  | 16,67 |     |     |       |

\* Check the price of left hand taps available in page 215.

\* Vc: Cutting Speed (m/min)

**HSSCo MACHINE TAPS**

|             |  |                           |                         |  |                              |                              |   |                          |
|-------------|--|---------------------------|-------------------------|--|------------------------------|------------------------------|---|--------------------------|
| <b>M MF</b> | <b>DIN 13</b><br> | <b>HSSCo</b><br><b>5%</b> | <b>TOL</b><br><b>6H</b> | <b>D</b><br><b>REDUCED</b><br><b>SHANK</b> | <b>DIN</b><br><b>376/374</b> | <b>Vc</b><br><b>12 m/min</b> | <b>R</b><br><b>REINFORCED</b><br><b>SHANK</b> | <b>DIN</b><br><b>371</b> |
|-------------|--|---------------------------|-------------------------|--|------------------------------|------------------------------|---|--------------------------|

|  |  | L1 x L2 x D2 x <br>mm | M1D       |           | M2D       |           | M3D    |     | M4D       |           | M1R     |       | M2R   |   | M3R   |   | M4R   |   |
|--|---|--|-----------|-----------|-----------|-----------|--------|-----|-----------|-----------|---------|-------|-------|---|-------|---|-------|---|
|  |   |  | C<br>FORM | B<br>FORM | C<br>FORM | B<br>FORM | 15°    | 35° | C<br>FORM | B<br>FORM | 15°     | 35°   | €     | € | €     | € | €     | € |
| M 6x1,25   | 4,75  | R 80 x 17 x 6,0 x 4,9  |           |           |           |           |        |     |           |           |         | 52,66 |       |   |       |   |       |   |
| M 7x0,75   | 6,25  | D 80 x 13 x 5,5 x 4,3  | 26,94     |           | 29,88     |           |        |     | 36,91     |           |         |       |       |   |       |   |       |   |
| M 7x1,00   | 6,00  | R 80 x 19 x 7,0 x 5,5<br>D 80 x 19 x 5,5 x 4,3   | 18,57     |           | 21,47     |           | 23,19  |     | 22,32     |           | 17,88 * |       | 20,87 |   | 23,60 |   | 23,36 |   |
| M 8x0,50   | 7,50  | D 80 x 13 x 6 x 4,9  | 36,24     |           |           |           |        |     |           |           |         |       |       |   |       |   |       |   |
| M 8x0,75   | 7,25  | D 80 x 13 x 6 x 4,9  | 26,25     |           | 32,19     |           |        |     | 39,92     |           |         |       |       |   |       |   |       |   |
| M 8x1,00   | 7,00  | D 90 x 20 x 6 x 4,9  | 21,47     |           | 24,64     |           | 29,53  |     | 27,30     |           |         |       |       |   |       |   |       |   |
| M 8x1,25   | 6,80  | R 90 x 22 x 8 x 6,2<br>D 90 x 22 x 6 x 4,9   | 15,49     |           | 16,18     |           | 21,95  |     | 18,82     |           | 15,58 * |       | 15,59 |   | 21,02 |   | 19,05 |   |
| M 8x1,50   | 6,50  | D 90 x 20 x 6 x 4,9  | 106,20    |           |           |           |        |     |           |           |         |       |       |   |       |   |       |   |
| M 9x1,00   | 8,00  | D 90 x 20 x 7 x 5,5  | 32,47     |           | 34,71     |           |        |     | 36,89     |           |         |       |       |   |       |   |       |   |
| M 9x1,25   | 7,80  | R 90 x 22 x 9 x 7,0<br>D 90 x 22 x 7 x 5,5   | 26,09     |           | 27,42     |           | 33,20  |     | 32,46     |           | 25,84   |       | 26,18 |   | 33,47 |   | 33,39 |   |
| M 10x0,50  | 9,50  | D 90 x 20 x 7 x 5,5  | 105,22    |           |           |           |        |     |           |           |         |       |       |   |       |   |       |   |
| M 10x0,75  | 9,25  | D 90 x 16 x 7 x 5,5  | 41,62     |           | 41,71     |           |        |     | 50,79     |           |         |       |       |   |       |   |       |   |
| M 10x1,00  | 9,00  | D 90 x 16 x 7 x 5,5  | 23,77     |           | 27,38     |           | 34,86  |     | 33,21     |           |         |       |       |   |       |   |       |   |
| M 10x1,25  | 8,80  | D 100 x 22 x 7 x 5,5   | 27,22     |           | 32,74     |           | 38,00  |     | 36,19     |           |         |       |       |   |       |   |       |   |
| M 10x1,50  | 8,50  | R 100 x 24 x 10 x 8,0<br>D 100 x 24 x 7 x 5,5  | 17,50     |           | 19,57     |           | 26,09  |     | 22,55     |           | 17,66 * |       | 19,20 |   | 24,14 |   | 22,55 |   |
| M 11x1,00  | 10,00   | D 90 x 20 x 8 x 6,2  | 42,61     |           | 44,01     |           | 111,26 |     | 101,24    |           |         |       |       |   |       |   |       |   |
| M 11x1,25  | 9,75  | D 100 x 22 x 8 x 6,2   | 40,77     |           | 45,30     |           | 111,26 |     | 90,37     |           |         |       |       |   |       |   |       |   |
| M 11x1,50  | 9,50  | D 100 x 24 x 8 x 6,2   | 33,05     |           | 38,00     |           | 81,12  |     | 73,78     |           |         |       |       |   |       |   |       |   |
| M 12x0,75  | 11,25   | D 100 x 22 x 9 x 7,0   | 62,43     |           |           |           |        |     |           |           |         |       |       |   |       |   |       |   |
| M 12x1,00  | 11,00   | D 100 x 22 x 9 x 7,0   | 32,33     |           | 37,00     |           | 43,01  |     | 42,55     |           |         |       |       |   |       |   |       |   |
| M 12x1,25  | 10,75   | D 100 x 22 x 9 x 7,0   | 32,73     |           | 36,35     |           | 41,18  |     | 40,73     |           |         |       |       |   |       |   |       |   |
| M 12x1,50  | 10,50   | D 100 x 22 x 9 x 7,0   | 29,25*    |           | 32,42     |           | 39,60  |     | 39,18     |           |         |       |       |   |       |   |       |   |
| M 12x1,75  | 10,20   | D 110 x 28 x 9 x 7,0   | 21,08*    |           | 24,44     |           | 33,37  |     | 28,76     |           |         |       |       |   |       |   |       |   |
| M 13x0,75  | 12,25   | D 100 x 22 x 11 x 9,0  | 108,97    |           |           |           |        |     |           |           |         |       |       |   |       |   |       |   |
| M 13x1,00  | 12,00   | D 100 x 22 x 11 x 9,0  | 57,71     |           | 65,34     |           |        |     |           |           |         |       |       |   |       |   |       |   |
| M 13x1,25  | 11,75   | D 100 x 22 x 11 x 9,0  | 57,71     |           | 65,34     |           |        |     |           |           |         |       |       |   |       |   |       |   |
| M 13x1,50  | 11,50   | D 100 x 22 x 11 x 9,0  | 57,71     |           | 65,34     |           |        |     |           |           |         |       |       |   |       |   |       |   |
| M 13x1,75  | 11,25   | D 100 x 28 x 11 x 9,0  | 57,30     |           | 65,34     |           |        |     |           |           |         |       |       |   |       |   |       |   |
| M 14x0,75  | 13,25   | D 100 x 22 x 11 x 9,0  | 108,97    |           |           |           |        |     |           |           |         |       |       |   |       |   |       |   |
| M 14x1,00  | 13,00   | D 100 x 22 x 11 x 9,0  | 52,04     |           | 57,25     |           | 66,31  |     | 65,75     |           |         |       |       |   |       |   |       |   |
| M 14x1,25  | 12,80   | D 100 x 22 x 11 x 9,0  | 44,29     |           | 48,34     |           | 60,82  |     | 57,94     |           |         |       |       |   |       |   |       |   |
| M 14x1,50  | 12,50   | D 100 x 22 x 11 x 9,0  | 34,84*    |           | 38,39     |           | 47,96  |     | 45,69     |           |         |       |       |   |       |   |       |   |
| M 14x2,00  | 12,00   | D 110 x 30 x 11 x 9,0  | 34,61*    |           | 38,45     |           | 44,56  |     | 44,56     |           |         |       |       |   |       |   |       |   |
| M 15x1,00  | 14,00   | D 100 x 22 x 12 x 9,0  | 66,18     |           | 70,07     |           |        |     | 89,22     |           |         |       |       |   |       |   |       |   |
| M 15x1,25  | 13,75   | D 100 x 22 x 12 x 9,0  | 70,89     |           | 76,77     |           |        |     |           |           |         |       |       |   |       |   |       |   |
| M 15x1,50  | 13,50   | D 100 x 22 x 12 x 9,0  | 56,66     |           | 64,62     |           | 165,08 |     | 133,91    |           |         |       |       |   |       |   |       |   |
| M 15x2,00  | 13,00   | D 110 x 30 x 12 x 9,0  | 69,35     |           | 76,32     |           |        |     |           |           |         |       |       |   |       |   |       |   |
| M 16x1,00  | 15,00   | D 100 x 22 x 12 x 9,0  | 62,38     |           | 66,18     |           | 92,84  |     | 90,14     |           |         |       |       |   |       |   |       |   |
| M 16x1,25  | 14,75   | D 100 x 22 x 12 x 9,0  | 66,75     |           | 73,37     |           | 103,25 |     | 99,98     |           |         |       |       |   |       |   |       |   |
| M 16x1,50  | 14,50   | D 100 x 22 x 12 x 9,0  | 41,19*    |           | 48,00     |           | 59,77  |     | 56,94     |           |         |       |       |   |       |   |       |   |
| M 16x2,00  | 14,00   | D 110 x 32 x 12 x 9,0  | 40,73*    |           | 44,98     |           | 53,83  |     | 53,83     |           |         |       |       |   |       |   |       |   |
| M 17x1,00  | 16,00   | D 100 x 22 x 12 x 9,0  | 124,11    |           |           |           |        |     |           |           |         |       |       |   |       |   |       |   |
| M 17x1,25  | 15,75   | D 100 x 22 x 12 x 9,0  | 124,11    |           |           |           |        |     |           |           |         |       |       |   |       |   |       |   |
| M 17x1,50  | 15,50   | D 100 x 22 x 12 x 9,0  | 124,11    |           |           |           |        |     |           |           |         |       |       |   |       |   |       |   |
| M 18x1,00  | 17,00   | D 110 x 25 x 14 x 11,0   | 69,86     |           | 76,78     |           |        |     | 110,30    |           |         |       |       |   |       |   |       |   |
| M 18x1,25  | 16,75   | D 110 x 25 x 14 x 11,0   | 86,58     |           |           |           |        |     |           |           |         |       |       |   |       |   |       |   |
| M 18x1,50  | 16,50   | D 110 x 25 x 14 x 11,0   | 54,54*    |           | 60,02     |           | 73,45  |     | 71,46     |           |         |       |       |   |       |   |       |   |
| M 18x2,00  | 16,00   | D 125 x 30 x 14 x 11,0   | 76,97     |           | 85,29     |           | 145,34 |     | 129,72    |           |         |       |       |   |       |   |       |   |

\* Check the price of left hand taps available in page 215.

\* Vc: Cutting Speed (m/min)

Threading tools  
Pink

## HSSCo MACHINE TAPS

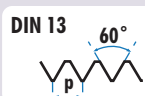
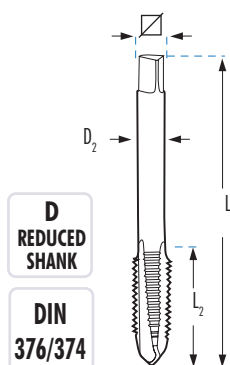
M  
MFHSSCo  
5%TOL  
6HD  
REDUCED  
SHANKDIN  
376/374Vc  
12 m/minD  
REDUCED  
SHANKDIN  
376/374

| M         | L1 x L2 x D2 x $\nabla$<br>mm | D                      | L1D     | L2D    | M3D    | M4D    |
|-----------|-------------------------------|------------------------|---------|--------|--------|--------|
|           |                               |                        |         |        |        |        |
|           |                               |                        | €       | €      | €      | €      |
| M 18x2,50 | 15,50                         | D 125 x 34 x 14 x 11,0 | 58,60*  | 64,07  | 72,48  | 69,80  |
| M 19x1,00 | 18,00                         | D 110 x 22 x 14 x 11,0 | 163,07  |        |        |        |
| M 19x1,25 | 17,75                         | D 110 x 25 x 14 x 11,0 | 167,70  |        |        |        |
| M 19x1,50 | 17,50                         | D 110 x 25 x 14 x 11,0 | 160,06  |        |        |        |
| M 20x1,00 | 19,00                         | D 125 x 25 x 16 x 12,0 | 92,22   | 102,41 |        | 117,81 |
| M 20x1,25 | 18,75                         | D 125 x 25 x 16 x 12,0 | 163,07  |        |        |        |
| M 20x1,50 | 18,50                         | D 125 x 25 x 16 x 12,0 | 61,77*  | 67,88  | 82,55  | 81,64  |
| M 20x2,00 | 18,00                         | D 140 x 32 x 16 x 12,0 | 80,96   | 89,01  |        | 105,09 |
| M 20x2,50 | 17,50                         | D 140 x 34 x 16 x 12,0 | 62,38*  | 69,17  | 77,35  | 77,36  |
| M 21x1,00 | 20,00                         | D 125 x 25 x 16 x 12,0 | 236,76  |        |        |        |
| M 21x1,25 | 19,75                         | D 125 x 25 x 16 x 12,0 | 236,76  |        |        |        |
| M 21x1,50 | 19,50                         | D 125 x 25 x 16 x 12,0 | 226,11  |        |        |        |
| M 22x1,00 | 21,00                         | D 125 x 25 x 18 x 14,5 | 103,38  | 109,73 |        | 151,82 |
| M 22x1,25 | 20,75                         | D 125 x 25 x 18 x 14,5 | 163,07  |        |        |        |
| M 22x1,50 | 20,50                         | D 125 x 25 x 18 x 14,5 | 74,35   | 81,78  | 90,55  | 85,20  |
| M 22x2,00 | 20,00                         | D 140 x 32 x 18 x 14,5 | 103,38  | 113,70 |        | 151,82 |
| M 22x2,50 | 19,50                         | D 140 x 34 x 18 x 14,5 | 75,48*  | 83,02  | 91,76  | 90,80  |
| M 23x1,00 | 22,00                         | D 125 x 25 x 18 x 14,5 | 230,18  |        |        |        |
| M 23x1,50 | 21,50                         | D 125 x 25 x 18 x 14,5 | 230,18  |        |        |        |
| M 24x1,00 | 23,00                         | D 140 x 25 x 18 x 14,5 | 112,65  | 136,66 |        | 160,41 |
| M 24x1,25 | 22,75                         | D 140 x 25 x 18 x 14,5 | 236,76  |        |        |        |
| M 24x1,50 | 22,50                         | D 140 x 28 x 18 x 14,5 | 91,44   | 100,54 | 121,03 | 115,29 |
| M 24x2,00 | 22,00                         | D 140 x 28 x 18 x 14,5 | 116,67* | 127,11 |        | 137,16 |
| M 24x3,00 | 21,00                         | D 160 x 38 x 18 x 14,5 | 90,36*  | 98,90  | 110,59 | 110,37 |
| M 25x1,00 | 24,00                         | D 140 x 28 x 18 x 14,5 | 218,39  |        |        |        |
| M 25x1,25 | 23,75                         | D 140 x 28 x 18 x 14,5 | 345,09  |        |        |        |
| M 25x1,50 | 23,50                         | D 140 x 28 x 18 x 14,5 | 142,28  | 150,58 |        |        |
| M 25x2,00 | 23,00                         | D 140 x 28 x 18 x 14,5 | 306,26  | 336,90 |        |        |
| M 26x1,00 | 25,00                         | D 140 x 28 x 18 x 14,5 | 169,55  |        |        |        |
| M 26x1,50 | 24,50                         | D 140 x 28 x 18 x 14,5 | 123,31  | 129,26 | 226,74 | 199,38 |
| M 26x2,00 | 24,00                         | D 140 x 28 x 18 x 14,5 | 238,83  | 262,72 |        | 288,56 |
| M 27x1,00 | 26,00                         | D 140 x 28 x 20 x 16,0 | 151,86  | 196,08 |        |        |
| M 27x1,50 | 25,50                         | D 140 x 28 x 20 x 16,0 | 134,64  | 142,63 | 329,52 | 297,12 |
| M 27x2,00 | 25,00                         | D 140 x 28 x 20 x 16,0 | 166,54* | 176,22 |        |        |

\* Check the price of left hand taps available in page 215.

\* Vc: Cutting Speed (m/min)

**HSSCo MACHINE TAPS**

**M**  
**MF**

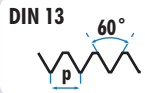

**HSSCo**  
**5%**

**TOL**  
**6H**





**D**  
**REDUCED**  
**SHANK**

**DIN**  
**376/374**



Threading tools

Pink

|  |  |  | L1 x L2 x D2 x $\square$<br>mm | M1D       | M2D       | M3D   | M4D   |
|---|---|---|--------------------------------|-----------|-----------|---|---|
|   |   |   |                                | C<br>FORM | B<br>FORM |  15° |  35° |
|   |   |   |                                | €         | €         | €   | €   |
| M 27x3,00   | 24,00   | D   | 160 x 36 x 20 x 16             | 112,80*   | 123,70    | 136,06  | 135,80  |
| M 28x1,00   | 27,00   | D   | 140 x 28 x 20 x 16             | 306,26    |           |   |   |
| M 28x1,50   | 26,50   | D   | 140 x 28 x 20 x 16             | 134,64    | 147,82    | 171,60  | 154,93  |
| M 28x2,00   | 26,00   | D   | 140 x 28 x 20 x 16             | 164,26    | 185,51    | 202,23  | 198,87  |
| M 30x1,00   | 29,00   | D   | 150 x 28 x 22 x 18             | 172,21    | 199,13    |   | 232,17  |
| M 30x1,50   | 28,50   | D   | 150 x 28 x 22 x 18             | 140,34    | 154,42    | 186,09  | 177,24  |
| M 30x2,00   | 28,00   | D   | 150 x 28 x 22 x 18             | 173,71*   | 184,37    |   | 255,11  |
| M 30x3,50   | 26,50   | D   | 180 x 40 x 22 x 18             | 144,55*   | 158,93    | 174,38  | 174,02  |
| M 32x1,00   | 31,00   | D   | 150 x 28 x 22 x 18             | 408,38    | 433,63    |   |   |
| M 32x1,50   | 30,50   | D   | 150 x 28 x 22 x 18             | 177,58    | 194,96    | 229,28  |   |
| M 32x2,00   | 30,00   | D   | 150 x 28 x 22 x 18             | 218,20    | 334,11    |   |   |
| M 33x1,00   | 32,00   | D   | 160 x 30 x 25 x 20             | 376,11    |           |   |   |
| M 33x1,50   | 31,50   | D   | 160 x 30 x 25 x 20             | 200,07    | 212,19    |   | 246,97  |
| M 33x2,00   | 31,00   | D   | 160 x 30 x 25 x 20             | 327,90    | 335,17    |   | 409,00  |
| M 33x3,50   | 29,50   | D   | 180 x 40 x 25 x 20             | 173,71*   | 199,88    |   | 221,70  |
| M 34x1,50   | 32,50   | D   | 170 x 30 x 28 x 22             | 222,82    | 236,04    |   |   |
| M 34x2,00   | 32,00   | D   | 160 x 30 x 28 x 22             | 468,60    |           |   |   |
| M 35x1,50   | 33,50   | D   | 170 x 30 x 28 x 22             | 234,99    | 258,48    |   | 282,66  |
| M 35x2,00   | 33,00   | D   | 170 x 30 x 28 x 22             | 432,41    | 476,03    |   |   |
| M 36x1,50   | 34,50   | D   | 170 x 30 x 28 x 22             | 214,57    | 253,67    |   | 307,06  |
| M 36x2,00   | 34,00   | D   | 170 x 30 x 28 x 22             | 289,81    | 301,25    |   |   |
| M 36x3,00   | 33,00   | D   | 200 x 50 x 28 x 22             | 332,50    | 345,58    |   | 444,41  |
| M 36x4,00   | 32,00   | D   | 200 x 50 x 28 x 22             | 227,99*   | 244,25    | 283,71  | 271,46  |
| M 38x1,50   | 36,50   | D   | 170 x 30 x 28 x 22             | 228,74    | 257,73    |   |   |
| M 38x2,00   | 36,00   | D   | 170 x 32 x 28 x 22             | 486,19    | 534,84    |   |   |
| M 39x1,50   | 37,50   | D   | 170 x 32 x 32 x 24             | 359,45    |           |   |   |
| M 39x2,00   | 37,00   | D   | 170 x 32 x 32 x 24             | 359,45    |           |   |   |
| M 39x3,00   | 36,00   | D   | 200 x 47 x 32 x 24             | 469,40    |           |   |   |
| M 39x4,00   | 35,00   | D   | 200 x 50 x 32 x 24             | 273,53    | 284,33    |   | 350,60  |
| M 40x1,50   | 38,50   | D   | 170 x 30 x 32 x 24             | 299,09    | 329,21    |   |   |
| M 40x2,00   | 38,00   | D   | 170 x 30 x 32 x 24             | 360,39    |           |   |   |
| M 40x3,00   | 37,00   | D   | 200 x 47 x 32 x 24             | 353,35    | 421,56    |   |   |
| M 42x1,50   | 40,50   | D   | 170 x 30 x 32 x 24             | 326,35    | 318,95    |   |   |
| M 42x2,00   | 40,00   | D   | 170 x 30 x 32 x 24             | 412,28    |           |   |   |
| M 42x3,00   | 39,00   | D   | 200 x 45 x 32 x 24             | 412,28    | 493,71    |   |   |
| M 42x4,50   | 37,50   | D   | 200 x 56 x 32 x 24             | 351,73    | 365,51    |   | 390,84  |
| M 45x1,50   | 43,50   | D   | 180 x 32 x 36 x 29             | 389,78    | 428,72    |   |   |
| M 45x2,00   | 43,00   | D   | 180 x 32 x 36 x 29             | 477,38    |           |   |   |
| M 45x3,00   | 42,00   | D   | 200 x 47 x 36 x 29             | 477,38    |           |   |   |
| M 45x4,50   | 40,50   | D   | 220 x 58 x 36 x 29             | 384,21    | 422,60    |   |   |
| M 48x1,50   | 46,50   | D   | 190 x 32 x 36 x 29             | 384,21    |           |   |   |
| M 48x2,00   | 46,00   | D   | 190 x 32 x 36 x 29             | 620,81    |           |   |   |
| M 48x3,00   | 45,00   | D   | 220 x 52 x 36 x 29             | 578,50    |           |   |   |
| M 48x5,00   | 43,00   | D   | 250 x 65 x 36 x 29             | 472,47    | 519,69    |   |   |
| M 50x1,50   | 48,50   | D   | 190 x 32 x 36 x 29             | 465,66    |           |   |   |
| M 52x1,50   | 50,50   | D   | 190 x 32 x 40 x 32             | 454,90    |           |   |   |
| M 52x2,00   | 50,00   | D   | 190 x 32 x 40 x 32             | 719,89    |           |   |   |
| M 52x3,00   | 49,00   | D   | 225 x 50 x 40 x 32             | 739,85    |           |   |   |
| M 52x5,00   | 47,00   | D   | 250 x 65 x 40 x 32             | 483,87    | 598,70    |   |   |

\* Check the price of left hand taps available in page 215.

\* Vc: Cutting Speed (m/min)

## HSSCo MACHINE TAPS

UNC

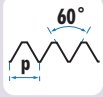
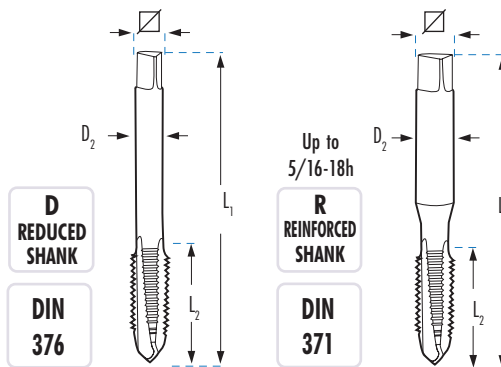
HSSCo  
5%TOL  
2BVc  
12 m/min

|              | D1<br>mm | Ø    | L1 x L2 x D2 x $\nabla$<br>mm | M1R            | M2R            | M4R      |
|--------------|----------|------|-------------------------------|----------------|----------------|----------|
|              |          |      |                               | C<br>FORM<br>€ | B<br>FORM<br>€ | 35°<br>€ |
| UNC n° 4-40h | 2,84     | 2,25 | R 56 x 11 x 3,5 x 2,7         | 26,92          | 32,01          | 36,53    |
| UNC n° 5-40h | 3,17     | 2,60 | R 56 x 11 x 3,5 x 2,7         | 27,90          | 33,47          | 36,53    |
| UNC n° 6-32h | 3,50     | 2,75 | R 56 x 12 x 4,0 x 3,0         | 26,55          | 31,91          | 36,37    |
| UNC n° 8-32h | 4,17     | 3,50 | R 63 x 13 x 4,5 x 3,4         | 26,55          | 31,91          | 34,79    |
| UNC n°10-24h | 4,83     | 3,90 | R 70 x 15 x 6,0 x 4,9         | 27,90          | 33,47          | 38,21    |
| UNC n°12-24h | 5,49     | 4,50 | R 80 x 16 x 6,0 x 4,9         | 29,27          | 33,47          | 35,07    |
| UNC 1/4-20h  | 6,35     | 5,10 | R 80 x 17 x 7,0 x 5,5         | 26,08          | 28,43          | 32,81    |
| UNC 5/16-18h | 7,94     | 6,60 | R 90 x 20 x 8,0 x 6,2         | 29,52          | 32,54          | 37,05    |

| REDUCED SHANK STANDARD PITCH |       |       |                          | M1D    | M2D    | M4D    |
|------------------------------|-------|-------|--------------------------|--------|--------|--------|
| UNC 3/8-16h                  | 9,52  | 8,00  | D 100 x 22 x 7,0 x 5,5   | 33,65  | 35,29  | 39,66  |
| UNC 7/16-14h                 | 11,11 | 9,40  | D 100 x 22 x 8,0 x 6,2   | 46,32  | 46,47  | 58,12  |
| UNC 1/2-13h                  | 12,70 | 10,75 | D 110 x 24 x 9,0 x 7,0   | 50,26  | 55,69  | 63,57  |
| UNC 9/16-12h                 | 14,28 | 12,20 | D 110 x 26 x 11,0 x 9,0  | 69,09  | 75,86  | 86,30  |
| UNC 5/8-11h                  | 15,87 | 13,50 | D 110 x 27 x 12,0 x 9,0  | 67,13  | 73,88  | 83,93  |
| UNC 3/4-10h                  | 19,05 | 16,50 | D 125 x 30 x 14,0 x 11,0 | 88,87  | 97,70  | 111,16 |
| UNC 7/8-9h                   | 22,22 | 19,50 | D 140 x 32 x 18,0 x 14,5 | 116,94 | 128,48 | 173,94 |
| UNC 1"-8h                    | 25,40 | 22,25 | D 160 x 36 x 18,0 x 14,5 | 154,52 | 168,80 | 218,20 |
| UNC 1.1/8-7h                 | 28,57 | 25,00 | D 180 x 40 x 22,0 x 18,0 | 201,83 |        | 243,80 |
| UNC 1.1/4-7h                 | 31,75 | 28,00 | D 180 x 40 x 22,0 x 18,0 | 236,57 |        | 311,89 |
| UNC 1.3/8-6h                 | 34,92 | 30,75 | D 200 x 50 x 28,0 x 22,0 | 352,86 |        |        |
| UNC 1.1/2-6h                 | 38,10 | 34,00 | D 200 x 50 x 32,0 x 24,0 | 400,72 |        |        |

\* Vc: Cutting Speed (m/min)

**HSSCo MACHINE TAPS**

**UNF**

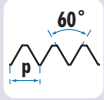

**HSSCo**  
**5%**

**TOL**  
**2B**

**Vc**  
**12 m/min**

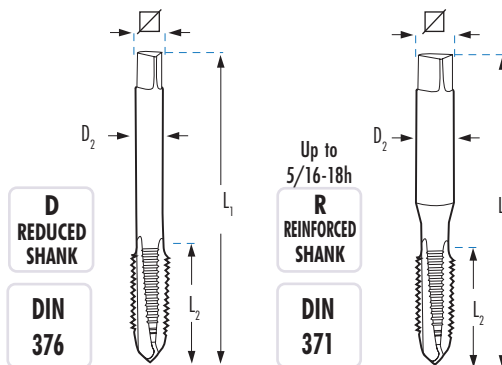

| UNF n°        | D1 mm | D2 mm | R | L1 x L2 x D2 x mm   | M1R    | M2R    | M4R   |
|---------------|-------|-------|---|---------------------|--------|--------|-------|
|               |       |       |   |                     | C FORM | B FORM | 35°   |
|               |       |       |   |                     | €      | €      | €     |
| UNF n° 4-48h  | 2,84  | 2,35  | R | 56 x 11 x 3,5 x 2,7 | 28,18  | 30,68  | 38,51 |
| UNF n° 5-44h  | 3,17  | 2,70  | R | 56 x 11 x 3,5 x 2,7 | 28,18  | 30,68  | 38,51 |
| UNF n° 6-40h  | 3,50  | 2,95  | R | 56 x 12 x 4,0 x 3,0 | 26,95  | 32,28  | 38,22 |
| UNF n° 8-36h  | 4,17  | 3,50  | R | 63 x 13 x 4,5 x 3,4 | 26,95  | 32,28  | 38,22 |
| UNF n° 10-32h | 4,83  | 4,10  | R | 70 x 15 x 6,0 x 4,9 | 26,95  | 32,28  | 38,22 |
| UNF n° 12-28h | 5,49  | 4,60  | R | 80 x 16 x 6,0 x 4,9 | 28,18  | 33,77  | 38,51 |
| UNF 1/4-28h   | 6,35  | 5,50  | R | 80 x 17 x 7,0 x 5,5 | 22,76  | 24,38  | 28,44 |
| UNF 5/16-24h  | 7,94  | 6,90  | R | 90 x 20 x 8,0 x 6,2 | 25,45  | 28,06  | 32,80 |

| REDUCED SHANK STANDARD PITCH |       |       |   | M1D                    | M2D    | M4D    |        |
|------------------------------|-------|-------|---|------------------------|--------|--------|--------|
| UNF                          |       |       | D |                        |        |        |        |
|                              |       |       |   | €                      | €      | €      |        |
| UNF 3/8-24h                  | 9,52  | 8,50  | D | 90 x 16 x 7,0 x 5,5    | 27,87  | 32,24  | 41,03  |
| UNF 7/16-20h                 | 11,11 | 9,90  | D | 100 x 22 x 8,0 x 6,2   | 34,38  | 39,85  | 52,61  |
| UNF 1/2-20h                  | 12,70 | 11,50 | D | 100 x 22 x 9,0 x 7,0   | 36,60  | 42,37  | 55,97  |
| UNF 9/16-18h                 | 14,29 | 12,90 | D | 100 x 22 x 11,0 x 9,0  | 44,97  | 52,08  | 69,30  |
| UNF 5/8-18h                  | 15,87 | 14,50 | D | 100 x 22 x 12,0 x 9,0  | 50,63  | 58,58  | 77,43  |
| UNF 3/4-16h                  | 19,05 | 17,50 | D | 110 x 25 x 14,0 x 11,0 | 64,79  | 75,02  | 99,04  |
| UNF 7/8-14h                  | 22,22 | 20,40 | D | 125 x 25 x 18,0 x 14,5 | 81,47  | 101,91 | 151,49 |
| UNF 1"-12h                   | 25,40 | 23,25 | D | 140 x 28 x 18,0 x 14,5 | 122,63 | 133,53 | 178,30 |
| UNS 1"-14h                   | 25,40 | 23,60 | D | 140 x 28 x 18,0 x 14,5 | 123,18 | 137,36 | 178,31 |
| UNF 1.1/8-12h                | 28,57 | 26,50 | D | 150 x 28 x 22,0 x 18,0 | 186,85 |        |        |
| UNF 1.1/4-12h                | 31,75 | 29,50 | D | 150 x 28 x 22,0 x 18,0 | 236,12 |        |        |
| UNF 1.1/2-12h                | 38,10 | 36,00 | D | 170 x 30 x 32,0 x 24,0 | 396,29 |        |        |

\* Vc: Cutting Speed (m/min)

**HSSCo MACHINE TAPS**

**BSP (GAS)**

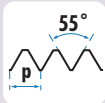

55°

**HSSCo**  
5%

**TOL**  
ISO 228

**INOX**

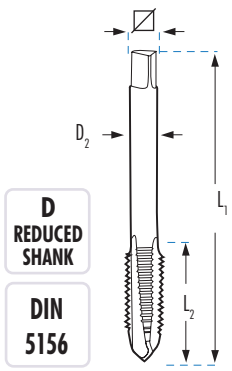

| Tap Type     | D1 mm  | D2 mm | L1 x L2 x D2 x mm      | HSSCo      |            |         |         | INOX        |          |
|--------------|--------|-------|------------------------|------------|------------|---------|---------|-------------|----------|
|              |        |       |                        | M1D C FORM | M2D B FORM | M3D 15° | M4D 35° | M2DX B FORM | M4DX 35° |
|              |        |       |                        | €          | €          | €       | €       | €           | €        |
| G 1/8-28h.   | 9,728  | 8,80  | D 90 x 16 x 7 x 5,5    | 35,64 *    | 40,71      | 41,71   | 43,22   | 62,93       | 62,28    |
| G 1/4-19h.   | 13,157 | 11,80 | D 100 x 22 x 11 x 9,0  | 49,42 *    | 54,41      | 59,89   | 62,07   | 84,78       | 90,74    |
| G 3/8-19h.   | 16,662 | 15,25 | D 100 x 22 x 12 x 9,0  | 59,18 *    | 65,11      | 71,54   | 74,12   | 100,58      | 106,64   |
| G 1/2-14h.   | 20,955 | 19,00 | D 125 x 25 x 16 x 12,0 | 74,79 *    | 82,30      | 90,23   | 93,47   | 124,53      | 134,60   |
| G 5/8-14h.   | 22,911 | 21,00 | D 125 x 25 x 18 x 14,5 | 93,20 *    | 97,74      | 112,34  | 111,30  |             |          |
| G 3/4-14h.   | 26,441 | 24,50 | D 140 x 28 x 20 x 16,0 | 117,06     | 128,85     | 141,23  | 146,33  | 188,16      | 207,59   |
| G 7/8-14h.   | 30,201 | 28,25 | D 150 x 28 x 22 x 18,0 | 157,36     | 165,54     | 189,95  | 188,17  |             |          |
| G 1"-11h.    | 33,249 | 30,75 | D 160 x 30 x 25 x 20,0 | 181,71     | 199,84     | 216,86  | 224,70  |             |          |
| G 1.1/8-11h. | 37,897 | 35,50 | D 170 x 30 x 28 x 22,0 | 290,16     | 316,50     |         | 347,61  |             |          |
| G 1.1/4-11h. | 41,910 | 39,50 | D 170 x 30 x 32 x 24,0 | 340,46     | 358,22     |         | 396,56  |             |          |
| G 1.3/8-11h. | 44,323 | 42,00 | D 180 x 32 x 36 x 29,0 | 407,12     |            |         | 550,85  |             |          |
| G 1.1/2-11h. | 47,803 | 45,25 | D 190 x 32 x 36 x 29,0 | 542,89     | 756,81     |         | 716,95  |             |          |
| G 1.3/4-11h. | 53,746 | 51,25 | D 190 x 32 x 40 x 32,0 | 645,29     | 746,53     |         |         |             |          |
| G 2"-11h.    | 59,614 | 57,00 | D 220 x 36 x 45 x 35,0 | 823,00     | 819,19     |         |         |             |          |

\* Also available in left-hand cutting: twice the standard price  
\* Vc: Cutting Speed (m/min)

**BSF**

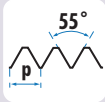

55°

**HSSCo**  
5%

**TOL**  
ISO 228

Vc  
12 m/min

**D REDUCED SHANK**

**DIN**  
5156

| Tap Type      | D1 mm  | D2 mm | L1 x L2 x D2 x mm        | M1D C FORM |
|---------------|--------|-------|--------------------------|------------|
|               |        |       |                          | €          |
| BSF 3/16-32h. | 4,762  | 4,00  | D 70 x 16 x 3,5 x 2,7    | 81,54      |
| BSF 1/4-26h.  | 6,350  | 5,20  | D 80 x 17 x 4,5 x 3,4    | 35,68      |
| BSF 5/16-22h. | 7,938  | 6,60  | D 90 x 20 x 6,0 x 4,9    | 42,37      |
| BSF 3/8-20h.  | 9,525  | 8,10  | D 100 x 22 x 7,0 x 5,5   | 44,54      |
| BSF 7/16-18h. | 11,113 | 9,50  | D 100 x 22 x 8,0 x 6,2   | 60,03      |
| BSF 1/2-16h.  | 12,700 | 11,00 | D 110 x 24 x 9,0 x 7,0   | 67,94      |
| BSF 9/16-16h. | 14,287 | 12,50 | D 110 x 25 x 11,0 x 9,0  | 71,90      |
| BSF 5/8-14h.  | 15,876 | 14,00 | D 110 x 27 x 12,0 x 9,0  | 95,83      |
| BSF 3/4-12h.  | 19,051 | 16,50 | D 125 x 30 x 14,0 x 11,0 | 113,44     |
| BSF 7/8-11h.  | 22,226 | 19,50 | D 140 x 32 x 18,0 x 14,5 | 157,66     |
| BSF 1"-10h.   | 25,400 | 22,50 | D 160 x 36 x 18,0 x 14,5 | 183,27     |

\* Vc: Cutting Speed (m/min)

**HSSCo MACHINE TAPS**

**BSW**



**HSSCo**  
**5%**

**TOL 2**  
**Class**

**Vc**  
**12 m/min**

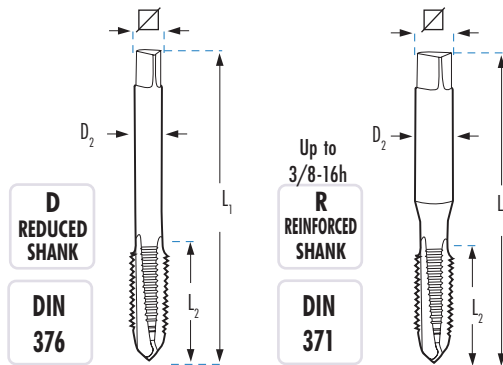

|             | D1 mm |      | L1 x L2 x D2 x $\nabla$ mm | M1R     | M2R    | M3R   | M4R   |
|-------------|-------|------|----------------------------|---------|--------|-------|-------|
|             |       |      |                            | C FORM  | B FORM | 15°   | 35°   |
|             |       |      |                            | €       | €      | €     | €     |
| W 3/32-48h. | 2,38  | 1,80 | R 50 x 9 x 2,8 x 2,1       | 24,77   | 26,44  |       |       |
| W 1/8-40h.  | 3,17  | 2,55 | R 56 x 11 x 3,5 x 2,7      | 20,66 * | 22,84  | 26,96 | 25,95 |
| W 5/32-32h. | 3,97  | 3,10 | R 63 x 13 x 4,5 x 3,4      | 20,66   | 22,84  | 26,96 | 25,95 |
| W 3/16-24h. | 4,76  | 3,60 | R 70 x 15 x 6,0 x 4,9      | 22,93   | 22,84  | 26,96 | 25,95 |
| W 7/32-24h. | 5,56  | 4,40 | R 80 x 16 x 6,0 x 4,9      | 31,37   | 33,17  |       |       |
| W 1/4-20h.  | 6,35  | 5,10 | R 80 x 17 x 7,0 x 5,5      | 22,07   | 25,95  | 30,61 | 31,71 |
| W 5/16-18h. | 7,94  | 6,50 | R 90 x 20 x 8,0 x 6,2      | 24,75   | 32,72  | 35,72 | 35,66 |
| W 3/8-16h.  | 9,52  | 7,90 | R 100 x 22 x 10,0 x 8,0    | 27,70   | 36,16  | 39,70 | 39,64 |

| REDUCED SHANK STANDARD PITCH |       |       |                          | M1D    | M2D    | M3D    | M4D    |
|------------------------------|-------|-------|--------------------------|--------|--------|--------|--------|
| W 7/16-14h.                  | 11,11 | 9,25  | D 100 x 22 x 8,0 x 6,2   | 38,52  | 39,83  | 50,04  | 50,40  |
| W 1/2-12h.                   | 12,70 | 10,50 | D 110 x 24 x 9,0 x 7,0   | 36,94  | 41,53  | 47,94  | 48,29  |
| W 9/16-12h.                  | 14,29 | 12,00 | D 110 x 26 x 11,0 x 9,0  | 52,95  | 54,99  | 68,76  | 69,25  |
| W 5/8-11h.                   | 15,87 | 13,40 | D 110 x 27 x 12,0 x 9,0  | 50,14  | 51,95  | 65,03  | 65,48  |
| W 3/4-10h.                   | 19,05 | 16,50 | D 125 x 30 x 14,0 x 11,0 | 70,17  | 72,84  | 87,12  | 87,74  |
| W 7/8-9h.                    | 22,22 | 19,25 | D 140 x 32 x 18,0 x 14,5 | 90,89  | 94,25  | 117,93 | 113,56 |
| W 1"-8h.                     | 25,40 | 21,75 | D 160 x 36 x 18,0 x 14,5 | 114,23 | 118,46 | 147,99 | 149,04 |
| W 1.1/8-7h.                  | 28,57 | 24,75 | D 180 x 40 x 22,0 x 18,0 | 154,92 | 176,52 | 212,25 |        |
| W 1.1/4-7h.                  | 31,75 | 27,75 | D 180 x 40 x 22,0 x 18,0 | 225,05 | 256,48 |        |        |
| W 1.3/8-6h.                  | 34,92 | 30,50 | D 200 x 50 x 28,0 x 22,0 | 369,90 | 421,19 |        |        |
| W 1.1/2-6h.                  | 38,10 | 33,50 | D 200 x 50 x 32,0 x 24,0 | 401,50 | 457,58 |        |        |
| W 1.5/8-5h.                  | 41,27 | 46,50 | D 220 x 65 x 32,0 x 24,0 | 560,42 | 638,72 |        |        |
| W 1.3/4-5h.                  | 44,45 | 39,00 | D 220 x 58 x 36,0 x 29,0 | 600,27 | 689,06 |        |        |
| W 1.7/8-4,5h.                | 47,62 | 42,00 | D 250 x 75 x 36,0 x 29,0 | 696,03 | 763,89 |        |        |
| W 2"-4,5h.                   | 50,80 | 44,50 | D 250 x 65 x 40,0 x 32,0 | 859,12 |        |        |        |

\* Also available in left-hand cutting: twice the standard price

\* Vc: Cutting Speed (m/min)

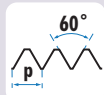
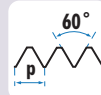
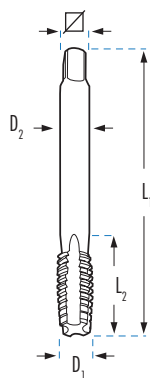
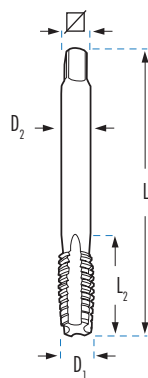
**HSSCo MACHINE TAPS**
**UNJC**

**HSSCo**  
**5%**
**TOL**  
**3B**
**UNJF**

**HSSCo**  
**5%**
**TOL**  
**3B**
**Vc**  
**12 m/min**

**Vc**  
**12 m/min**

| UNJC n°       | D1 mm | Ø    | L1 x L2 x D2 x         | MIR    |              |
|---------------|-------|------|------------------------|--------|--------------|
|               |       |      |                        | C FORM | €            |
| UNJC n° 4-40h | 2,84  | 2,25 | R 56 x 11 x 3,5 x 2,7  |        | <b>40,89</b> |
| UNJC n° 5-40h | 3,17  | 2,60 | R 56 x 11 x 3,5 x 2,7  |        | <b>40,89</b> |
| UNJC n° 6-32h | 3,50  | 2,75 | R 56 x 12 x 4,0 x 3,0  |        | <b>40,89</b> |
| UNJC n° 8-32h | 4,17  | 3,50 | R 63 x 13 x 4,5 x 3,4  |        | <b>40,89</b> |
| UNJC n°10-24h | 4,83  | 3,90 | R 70 x 15 x 6,0 x 4,9  |        | <b>40,89</b> |
| UNJC n°12-24h | 5,49  | 4,50 | R 80 x 16 x 6,0 x 4,9  |        | <b>42,89</b> |
| UNJC 1/4-20h  | 6,35  | 5,10 | R 80 x 17 x 7,0 x 5,5  |        | <b>38,16</b> |
| UNJC 5/16-18h | 7,94  | 6,60 | R 90 x 20 x 8,0 x 6,2  |        | <b>43,18</b> |
| UNJC 3/8-16h  | 9,52  | 8,00 | R 100 x 22 x 8,0 x 6,2 |        | <b>49,22</b> |

| UNJF n°       | D1 mm | Ø    | L1 x L2 x D2 x        | MIR    |              |
|---------------|-------|------|-----------------------|--------|--------------|
|               |       |      |                       | C FORM | €            |
| UNJF n° 4-48h | 2,84  | 2,35 | R 56 x 11 x 3,5 x 2,7 |        | <b>44,86</b> |
| UNJF n° 5-44h | 3,17  | 2,70 | R 56 x 11 x 3,5 x 2,7 |        | <b>44,86</b> |
| UNJF n° 6-40h | 3,50  | 2,95 | R 56 x 12 x 4,0 x 3,0 |        | <b>44,86</b> |
| UNJF n° 8-36h | 4,17  | 3,50 | R 63 x 13 x 4,5 x 3,4 |        | <b>44,86</b> |
| UNJF n°10-32h | 4,83  | 4,10 | R 70 x 15 x 6,0 x 4,9 |        | <b>44,86</b> |
| UNJF n°12-28h | 5,49  | 4,60 | R 80 x 16 x 6,0 x 4,9 |        | <b>44,86</b> |
| UNJF 1/4-28h  | 6,35  | 5,50 | R 80 x 17 x 7,0 x 5,5 |        | <b>34,83</b> |
| UNJF 5/16-24h | 7,94  | 6,90 | R 90 x 20 x 8,0 x 6,2 |        | <b>38,94</b> |
| UNJF 3/8-24h  | 9,52  | 8,50 | R 90 x 16 x 7,0 x 6,2 |        | <b>42,64</b> |

| REDUCED SHANK STANDARD PITCH |       |       |                          | M1D           |
|------------------------------|-------|-------|--------------------------|---------------|
| UNJC 7/16-14h                | 11,11 | 9,40  | D 110 x 24 x 9,0 x 7,0   | <b>67,88</b>  |
| UNJC 1/2-13h                 | 12,70 | 10,75 | D 110 x 26 x 11,0 x 9,0  | <b>73,68</b>  |
| UNJC 9/16-12h                | 14,28 | 12,20 | D 110 x 27 x 12,0 x 9,0  | <b>101,27</b> |
| UNJC 5/8-11h                 | 15,87 | 13,50 | D 110 x 27 x 12,0 x 9,0  | <b>103,81</b> |
| UNJC 3/4-10h                 | 19,05 | 16,50 | D 125 x 30 x 14,0 x 11,0 | <b>130,25</b> |
| UNJC 7/8-9h                  | 22,22 | 19,50 | D 140 x 32 x 18,0 x 14,5 | <b>171,39</b> |
| UNJC 1"-8h                   | 25,40 | 22,25 | D 160 x 36 x 18,0 x 14,5 | <b>226,44</b> |

| REDUCED SHANK STANDARD PITCH |       |       |                          | M1D           |
|------------------------------|-------|-------|--------------------------|---------------|
| UNJF 7/16-20h                | 11,11 | 9,90  | D 100 x 22 x 8,0 x 6,2   | <b>58,56</b>  |
| UNJF 1/2-20h                 | 12,70 | 11,50 | D 100 x 22 x 9,0 x 7,0   | <b>62,36</b>  |
| UNJF 9/16-18h                | 14,29 | 12,90 | D 100 x 22 x 11,0 x 9,0  | <b>76,62</b>  |
| UNJF 5/8-18h                 | 15,87 | 14,50 | D 100 x 22 x 12,0 x 9,0  | <b>86,26</b>  |
| UNJF 3/4-16h                 | 19,05 | 17,50 | D 110 x 25 x 14,0 x 11,0 | <b>110,36</b> |
| UNJF 7/8-14h                 | 22,22 | 20,40 | D 125 x 25 x 18,0 x 14,5 | <b>138,77</b> |
| UNJF 1"-12h                  | 25,40 | 23,25 | D 140 x 28 x 18,0 x 14,5 | <b>154,72</b> |

\* Vc: Cutting Speed (m/min)

**HSSCo MACHINE TAPS**

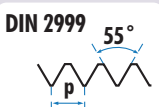
**BSP**  **HSSCo 5%** **DIN 374** **C FORM**

**BSPT**  **HSSCo 5%** **DIN 5156** **C FORM**

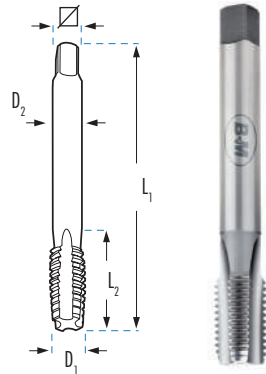

BRITISH STANDARD PIPE

BRITISH STANDARD TAPER PIPE

|  | D1 mm | L1 x L2 x D2 x $\nabla$ mm | M1D | €             |
|---|-------|----------------------------|-----|---------------|
| Rp 1/16-28h.  | 7,72  | D 90 x 16 x 6 x 4,9        |     |               |
| Rp 1/8-28h.   | 9,73  | D 90 x 16 x 7 x 5,5        |     | <b>53,18</b>  |
| Rp 1/4-19h.   | 13,16 | D 100 x 22 x 11 x 9,0      |     | <b>73,46</b>  |
| Rp 3/8-19h.   | 16,66 | D 100 x 22 x 12 x 9,0      |     | <b>87,96</b>  |
| Rp 1/2-14h.   | 20,95 | D 125 x 25 x 16 x 12,0     |     | <b>111,16</b> |
| Rp 3/4-14h.   | 26,44 | D 140 x 28 x 20 x 16,0     |     | <b>174,07</b> |
| Rp 1"-11h.  | 33,25 | D 160 x 30 x 25 x 20,0     |     | <b>270,08</b> |
| Rp 1.1/4-11h.   | 41,91 | D 170 x 30 x 32 x 24,0     |     |               |
| Rp 1.1/2-11h.   | 46,80 | D 190 x 32 x 36 x 29,0     |     |               |
| Rp 2"-11h.  | 59,61 | D 220 x 36 x 45 x 35,0     |     |               |

|  | D1 mm | $\theta$ | L1 x L2 x D2 x $\nabla$ mm | M1D | €             |
|---|-------|----------|----------------------------|-----|---------------|
| Rc 1/16-28h.  | 7,72  |          | D 90 x 14 x 6 x 4          |     |               |
| Rc 1/8-28h.   | 9,73  | 8,30     | D 90 x 15 x 7 x 5          |     | <b>54,41</b>  |
| Rc 1/4-19h.   | 13,16 | 11,00    | D 100 x 19 x 11 x 9        |     | <b>78,26</b>  |
| Rc 3/8-19h.   | 16,66 | 14,50    | D 100 x 21 x 12 x 9        |     | <b>108,76</b> |
| Rc 1/2-14h.   | 20,95 | 18,10    | D 125 x 26 x 16 x 12       |     | <b>151,12</b> |
| Rc 5/8-14h.   | 22,91 | 21,00    | D 140 x 36 x 18 x 19       |     | <b>243,77</b> |
| Rc 3/4-14h.   | 26,44 | 23,50    | D 140 x 28 x 20 x 16       |     | <b>235,69</b> |
| Rc 7/8-14h.   | 30,20 | 28,25    | D 160 x 36 x 22 x 18       |     | <b>410,13</b> |
| Rc 1"-11h.  | 33,25 | 29,60    | D 160 x 33 x 25 x 20       |     | <b>337,80</b> |

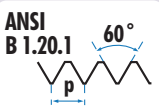
**NPS (M)**  **HSSCo 5%** **DIN 374** **C FORM**

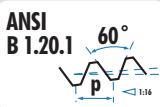
**NPT**  **HSSCo 5%** **DIN 374** **C FORM**

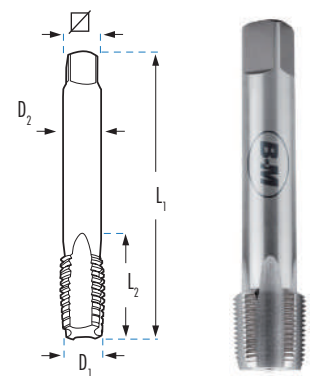
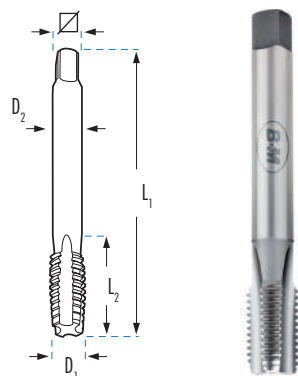

NATIONAL STRAIGHT PIPE MECHANICAL

NATIONAL TAPER PIPE

|  | D1 mm | $\theta$ | L1 x L2 x D2 x $\nabla$ mm | M1D | €             |
|---|-------|----------|----------------------------|-----|---------------|
| NPS 1/8-27h.  | 10,20 | 8,90     | D 90 x 16 x 7 x 5,5        |     | <b>136,98</b> |
| NPS 1/4-18h.  | 13,60 | 11,70    | D 100 x 22 x 11 x 9,0      |     | <b>196,06</b> |
| NPS 3/8-18h.  | 17,00 | 15,00    | D 100 x 22 x 12 x 9,0      |     | <b>268,85</b> |
| NPS 1/2-14h.  | 21,20 | 18,60    | D 125 x 25 x 16 x 12,0     |     | <b>368,67</b> |
| NPS 3/4-14h.  | 26,55 | 24,00    | D 140 x 28 x 20 x 16,0     |     | <b>545,00</b> |
| NPS 1"-11,5 h.  | 33,20 | 30,00    | D 160 x 30 x 25 x 20,0     |     | <b>704,79</b> |
| NPS 1.1/4-11,5h.  | 41,60 |          | D 170 x 30 x 32 x 24,0     |     |               |
| NPS 1.1/2-11,5h.  | 47,68 |          | D 190 x 32 x 36 x 29,0     |     |               |
| NPS 2"-11,5h.   | 59,71 |          | D 220 x 36 x 45 x 35,0     |     |               |

|  | D1 mm | $\theta$ | L1 x L2 x D2 x $\nabla$ mm | M1D | €             |
|---|-------|----------|----------------------------|-----|---------------|
| NPT 1/16-27h.   | 7,89  | 6,2      | D 90 x 14 x 6 x 5          |     | <b>47,66</b>  |
| NPT 1/8-27h.  | 10,24 | 8,5      | D 90 x 15 x 8 x 6          |     | <b>49,84</b>  |
| NPT 1/4-18h.  | 13,62 | 11,0     | D 100 x 19 x 11 x 9        |     | <b>64,37</b>  |
| NPT 3/8-18h.  | 17,05 | 14,5     | D 100 x 21 x 12 x 9        |     | <b>82,74</b>  |
| NPT 1/2-14h.  | 21,22 | 17,8     | D 125 x 26 x 16 x 12       |     | <b>107,64</b> |
| NPT 3/4-14h.  | 26,57 | 23,0     | D 140 x 28 x 20 x 16       |     | <b>166,77</b> |
| NPT 1"-11,5h.   | 33,23 | 29,0     | D 160 x 33 x 25 x 20       |     | <b>216,76</b> |
| NPT 1.1/4-11,5h.  | 41,98 | 37,5     | D 170 x 36 x 32 x 24       |     | <b>295,95</b> |
| NPT 1.1/2-11,5h.  | 48,05 | 44,0     | D 190 x 37 x 36 x 29       |     | <b>466,01</b> |
| NPT 2"-11,5h.   | 60,09 | 56,0     | D 220 x 41 x 45 x 35       |     | <b>730,99</b> |

**HSSCo MACHINE TAPS**

**NPSF** HSSCo 5% DIN 374 C FORM

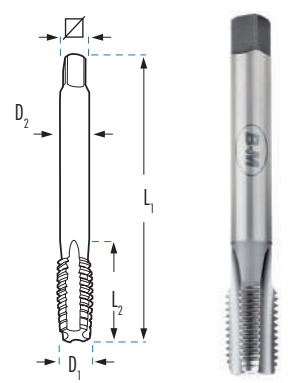
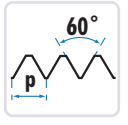

NATIONAL STRAIGHT PIPE DRYSEAL

|      |           | D1 mm | $\emptyset$ | L1 x L2 x D2 x $\nabla$ mm | M1D €  |
|------|-----------|-------|-------------|----------------------------|--------|
| NPSF | 1/8-27h.  | 10,05 | 8,75        | D 90 x 16 x 7 x 5,5        | 171,59 |
| NPSF | 1/4-18h.  | 13,33 | 11,30       | D 100 x 22 x 11 x 9,0      | 236,51 |
| NPSF | 3/8-18h.  | 16,78 | 14,70       | D 100 x 22 x 12 x 9,0      | 336,46 |
| NPSF | 1/2-14h.  | 20,87 | 18,20       | D 125 x 25 x 16 x 12,0     | 419,58 |
| NPSF | 3/4-14h.  | 26,23 | 23,50       | D 140 x 28 x 20 x 16,0     | 686,70 |
| NPSF | 1"-11,5h. | 32,81 | 29,50       | D 160 x 30 x 25 x 20,0     |        |

**NPTF** HSSCo 5% DIN 374 C FORM

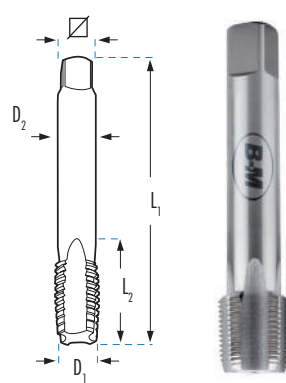
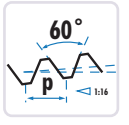

NATIONAL TAPER PIPE DRYSEAL

|      |           | D1 mm | $\emptyset$ | L1 x L2 x D2 x $\nabla$ mm | M1D €  |
|------|-----------|-------|-------------|----------------------------|--------|
| NPTF | 1/16-27h. | 7,87  | 6,20        | D 90 x 14 x 12,0 x 6       |        |
| NPTF | 1/8-27h.  | 10,22 | 8,50        | D 90 x 15 x 12,0 x 7       | 115,93 |
| NPTF | 1/4-18h.  | 13,58 | 11,00       | D 100 x 21 x 17,5 x 11     | 162,65 |
| NPTF | 3/8-18h.  | 17,02 | 14,50       | D 110 x 21 x 17,6 x 12     | 208,94 |
| NPTF | 1/2-14h.  | 21,21 | 17,80       | D 140 x 27 x 22,8 x 16     | 272,00 |
| NPTF | 3/4-14h.  | 26,56 | 23,00       | D 140 x 27 x 23,0 x 20     | 421,39 |

**MF** HSSCo 5% TOL 6H C FORM DIN 374

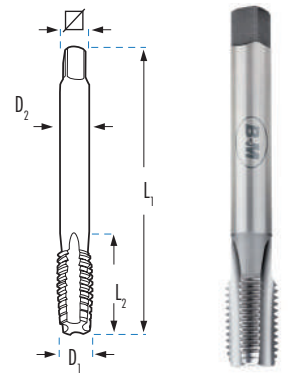
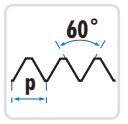

METRIC FINE FOR ELECTRICIAN PIPE NORM EN 60423

|    |           | D1 mm | $\emptyset$ | L1 x L2 x D2 x $\nabla$ mm | M1D €  |
|----|-----------|-------|-------------|----------------------------|--------|
| MF | 12 x 1,50 | 12    | 10,5        | D 100 x 22 x 9 x 7,0       | 29,25  |
| MF | 16 x 1,50 | 16    | 14,5        | D 100 x 22 x 12 x 9,0      | 41,19  |
| MF | 20 x 1,50 | 20    | 18,5        | D 125 x 25 x 16 x 12,0     | 61,77  |
| MF | 25 x 1,50 | 25    | 23,5        | D 140 x 28 x 18 x 14,5     | 142,28 |
| MF | 32 x 1,50 | 32    | 30,5        | D 150 x 28 x 22 x 18,0     | 177,58 |
| MF | 40 x 1,50 | 40    | 38,5        | D 170 x 30 x 32 x 24,0     | 299,09 |
| MF | 50 x 1,50 | 50    | 48,5        | D 190 x 32 x 36 x 29,0     | 465,66 |
| MF | 63 x 1,50 | 63    | 61,5        | D 275 x 36 x 50 x 39,0     |        |

**PG** HSSCo 5% DIN 40430 C FORM

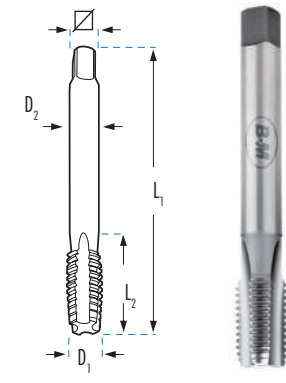
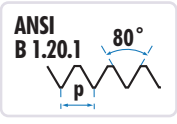

ARMOUR PIPE STEEL CONDUIT

|    |             | D1 mm | $\emptyset$ | L1 x L2 x D2 x $\nabla$ mm | M1D €    |
|----|-------------|-------|-------------|----------------------------|----------|
| PG | 7 - 20h.    | 12,5  | 11,50       | D 100 x 22 x 9 x 7,0       | 50,87    |
| PG | 9 - 18h.    | 15,2  | 14,00       | D 100 x 22 x 12 x 9,0      | 70,46    |
| PG | 11 - 18h.   | 18,6  | 17,25       | D 110 x 25 x 14 x 11,0     | 91,67    |
| PG | 13,5 - 18h. | 20,4  | 19,00       | D 125 x 25 x 16 x 12,0     | 102,94   |
| PG | 16 - 18h.   | 22,5  | 21,25       | D 125 x 25 x 18 x 14,5     | 121,15   |
| PG | 21 - 16h.   | 28,3  | 27,00       | D 150 x 28 x 22 x 18,0     | 192,33   |
| PG | 29 - 16h.   | 37,0  | 35,50       | D 170 x 30 x 28 x 22,0     | 325,13   |
| PG | 36 - 16h.   | 47,0  | 45,50       | D 190 x 32 x 36 x 29,0     | 528,03   |
| PG | 42 - 16h.   | 54,0  | 52,50       | D 190 x 32 x 40 x 32,0     | 838,60   |
| PG | 48 - 16h.   | 59,3  | 58,00       | D 220 x 36 x 45 x 35,0     | 1.022,32 |

**HSSCo MACHINE TAPS**

**UNx8** HSSCo 5% DIN 374 C FORM TOL 2B

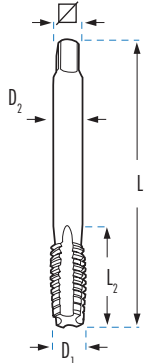
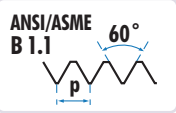

**UNEF** HSSCo 5% DIN 374 TOL 2B

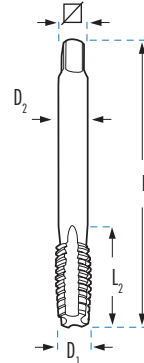
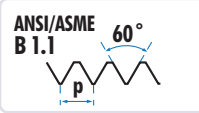

| Icon | Ø | D2 mm | L1 x L2 x mm | M1D   |
|------|---|-------|--------------|---|
|      |   |       |              | C FORM €                                    |
|      |   |       |              | UN 1" 1/8-8h. 25,40 22 180 x 45 x 18 252,89 |
|      |   |       |              | UN 1" 1/4-8h. 28,50 22 180 x 48 x 18 326,28 |
|      |   |       |              | UN 1" 3/8-8h. 31,75 28 200 x 56 x 22 370,11 |
|      |   |       |              | UN 1" 1/2-8h. 35,00 32 200 x 58 x 22 470,91 |
|      |   |       |              | UN 1" 5/8-8h. 38,10 32 200 x 65 x 24 550,85 |
|      |   |       |              | UN 1" 3/4-8h. 41,25 36 200 x 50 x 29 671,02 |
|      |   |       |              | UN 1" 7/8-8h. 44,45 36 225 x 53 x 29 774,04 |
|      |   |       |              | UN 2"-8h. 47,63 40 225 x 50 x 32 790,89     |

| Icon | Ø | D2 mm | L1 x L2 x mm | M2D  | M4D   |
|------|---|-------|--------------|--|-------|
|      |   |       |              | B FORM €   | 35° € |
|      |   |       |              | UNEF 1/4-32h. 5,55 7,0 R 82 x 16 x 5,4 104,64 117,60     |       |
|      |   |       |              | UNEF 5/16-32h. 7,15 8,4 R 85 x 21 x 6,1 115,30 129,55    |       |
|      |   |       |              | UNEF 3/8-32h. 8,70 7,0 D 95 x 22 x 5,4 115,36 129,62     |       |
|      |   |       |              | UNEF 7/16-28h. 10,20 8,0 D 100 x 22 x 6,2 153,12 172,04  |       |
|      |   |       |              | UNEF 1/2-28h. 11,80 9,0 D 100 x 22 x 7,0 161,28 181,22   |       |
|      |   |       |              | UNEF 9/16-24h. 13,20 12,0 D 100 x 24 x 9,0 202,06 227,04 |       |
|      |   |       |              | UNEF 5/8-24h. 14,80 12,0 D 100 x 24 x 9,0 229,94 258,36  |       |
|      |   |       |              | UNEF 3/4-20h. 17,80 14,0 D 110 x 27 x 11,0 299,05 336,04 |       |
|      |   |       |              | UNEF 7/8-20h. 20,95 18,0 D 125 x 26 x 14,5 321,46 344,42 |       |
|      |   |       |              | UNEF 1"-20h. 24,20 18,0 D 140 x 28 x 14,5 491,94 552,74  |       |

**HSSCo MACHINE TAPS LEFT-HAND**

**M MF** HSSCo 5% C FORM TOL 6H

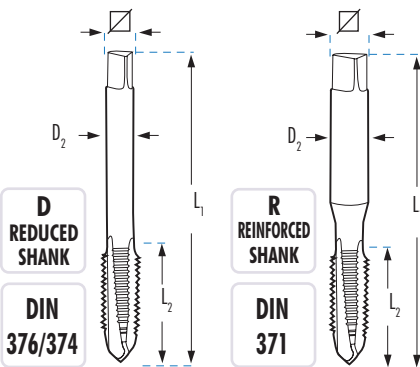
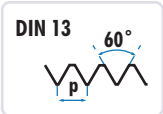

| Icon | Ø | L1 x L2 x D2 x mm | M1R1   |
|------|---|-------------------|--|
|      |   |                   | C FORM €                                     |
|      |   |                   | M 3x0,50 2,50 R 56 x 11 x 3,5 x 2,7 23,79    |
|      |   |                   | M 4x0,70 3,30 R 63 x 13 x 4,5 x 3,4 27,07    |
|      |   |                   | M 5x0,80 4,20 R 70 x 16 x 6,0 x 4,9 24,23    |
|      |   |                   | M 6x1,00 5,00 R 80 x 17 x 6,0 x 4,9 27,57    |
|      |   |                   | M 7x1,00 6,00 R 80 x 17 x 7,0 x 5,5 35,76    |
|      |   |                   | M 8x1,25 6,80 R 90 x 20 x 8,0 x 6,2 31,16    |
|      |   |                   | M 10x1,50 8,50 R 100 x 22 x 10,0 x 8,0 35,32 |

| REDUCED SHANK STANDARD PITCH                    |  |  | M1D1 |
|---|--|--|------|
| M 12x1,50 10,50 D 100 x 22 x 9,0 x 7,0 58,51    |  |  |      |
| M 12x1,75 10,20 D 110 x 24 x 9,0 x 7,0 42,17    |  |  |      |
| M 14x1,50 12,50 D 100 x 22 x 11,0 x 9,0 69,68   |  |  |      |
| M 14x2,00 12,00 D 110 x 26 x 11,0 x 9,0 69,22   |  |  |      |
| M 16x1,50 14,50 D 100 x 22 x 12,0 x 9,0 82,38   |  |  |      |
| M 16x2,00 14,00 D 110 x 27 x 12,0 x 9,0 81,46   |  |  |      |
| M 18x1,50 16,50 D 110 x 25 x 14,0 x 11,0 109,07 |  |  |      |
| M 18x2,50 15,50 D 125 x 30 x 14,0 x 11,0 117,20 |  |  |      |
| M 20x1,50 18,50 D 125 x 25 x 16,0 x 12,0 123,54 |  |  |      |
| M 20x2,50 17,50 D 140 x 32 x 16,0 x 12,0 124,76 |  |  |      |
| M 22x2,50 19,50 D 140 x 32 x 18,0 x 14,5 150,97 |  |  |      |
| M 24x2,00 22,00 D 140 x 28 x 18,0 x 14,5 233,33 |  |  |      |
| M 24x3,00 21,00 D 160 x 34 x 18,0 x 14,5 180,73 |  |  |      |
| M 27x3,00 24,00 D 160 x 36 x 20,0 x 16,0 225,60 |  |  |      |
| M 30x2,00 28,00 D 150 x 28 x 22,0 x 18,0 347,42 |  |  |      |
| M 30x3,50 26,50 D 180 x 40 x 22,0 x 18,0 289,11 |  |  |      |
| M 33x3,50 29,50 D 180 x 40 x 25,0 x 20,0 347,42 |  |  |      |
| M 36x4,00 32,00 D 200 x 50 x 28,0 x 22,0 455,97 |  |  |      |

Check other dimensions upon request



\* Vc: Cutting Speed (m/min)

## HSSCo MACHINE TAPS ISO 529

M  
MF

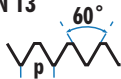
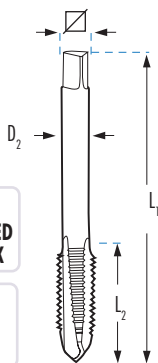
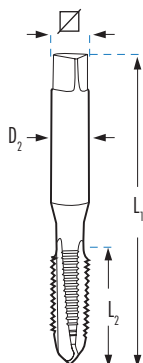
DIN 13

HSSCo  
5%ISO  
529TOL  
6HD  
REDUCED  
SHANK  
  
ISO  
529R  
REINFORCED  
SHANK  
  
ISO  
529

|  |  | L1 x L2 x D2 x $\square$<br>mm | M1RISO    | M2RISO    | M4RISO   | M5RISO |
|---|---|--------------------------------|-----------|-----------|--|--------|
|   |   |                                | C<br>FORM | B<br>FORM |  35°<br>INTERRUPTED<br>THREAD<br>AI | €      |
| M 3x0,50  | 2,50  | R 48 x 11 x 3,15 x 2,50        | 8,58      | 8,95      | 10,77  | 12,81  |
| M 4x0,70  | 3,30  | R 53 x 13 x 4,00 x 3,15        | 8,58      | 8,95      | 10,77  | 12,81  |
| M 5x0,80  | 4,20  | R 58 x 16 x 5,00 x 4,00        | 8,58      | 8,95      | 10,77  | 12,81  |
| M 6x1,00  | 5,00  | R 66 x 19 x 6,30 x 5,00        | 8,58      | 8,95      | 11,00  | 12,81  |
| M 7x1,00  | 6,00  | R 66 x 19 x 7,10 x 5,60        |           | 12,73     | 14,61  |        |
| M 8x1,00  | 7,00  | R 69 x 19 x 8,00 x 6,30        |           | 17,56     | 18,02  |        |
| M 8x1,25  | 6,75  | R 72 x 22 x 8,00 x 6,30        | 11,47     | 11,94     | 12,35  | 14,00  |
| M 9x1,25  | 7,75  | R 76 x 20 x 10,00 x 8,00       |           | 18,99     | 21,69  |        |
| M 10x1,00   | 9,00  | R 76 x 20 x 10,00 x 8,00       |           | 20,14     | 22,00  |        |
| M 10x1,25   | 8,80  | R 76 x 20 x 10,00 x 8,00       |           | 24,08     | 24,85  |        |
| M 10x1,50   | 8,50  | R 80 x 24 x 10,00 x 8,00       | 14,58     | 15,19     | 15,92  | 17,66  |
| <b>REDUCED SHANK</b>  |   |                                | M1DISO    | M2DISO    | M4DISO   | M5DISO |
| M 12x1,00   | 11,00   | D 84 x 24 x 9,00 x 7,10        |           | 27,74     | 28,42  |        |
| M 12x1,25   | 10,75   | D 84 x 24 x 9,00 x 7,10        |           | 27,25     | 28,21  |        |
| M 12x1,50   | 10,50   | D 89 x 29 x 9,00 x 7,10        |           | 24,31     | 26,18  |        |
| M 12x1,75   | 10,20   | D 89 x 29 x 9,00 x 7,10        | 18,74     | 19,52     | 20,67  | 26,42  |
| M 14x1,00   | 13,00   | D 90 x 25 x 11,20 x 9,00       |           | 34,74     | 43,22  |        |
| M 14x1,25   | 12,80   | D 90 x 25 x 11,20 x 9,00       |           | 29,34     | 36,74  |        |
| M 14x1,50   | 12,50   | D 95 x 30 x 12,50 x 9,00       |           | 25,78     | 28,97  |        |
| M 14x2,00   | 12,00   | D 95 x 30 x 11,20 x 9,00       | 22,41     | 23,34     | 28,26  |        |
| M 16x1,00   | 15,00   | D 95 x 25 x 12,50 x 10,00      |           | 44,21     | 56,89  |        |
| M 16x1,25   | 14,75   | D 102 x 32 x 12,50 x 10,00     |           | 49,01     | 63,08  |        |
| M 16x1,50   | 14,50   | D 102 x 32 x 14,00 x 10,00     |           | 30,94     | 34,67  |        |
| M 16x2,00   | 14,00   | D 102 x 32 x 12,50 x 10,00     | 27,83     | 28,98     | 32,78  |        |
| M 18x1,50   | 16,50   | D 104 x 29 x 14,00 x 11,20     |           | 40,88     | 55,86  |        |
| M 18x2,50   | 15,50   | D 112 x 37 x 14,00 x 11,20     | 41,90     | 43,64     | 54,56  |        |
| M 20x1,50   | 18,50   | D 104 x 29 x 14,00 x 11,20     |           | 52,61     | 64,34  |        |
| M 20x2,50   | 17,50   | D 112 x 37 x 14,00 x 11,20     | 46,83     | 48,78     | 60,97  |        |
| M 22x2,50   | 19,50   | D 118 x 38 x 16,00 x 12,50     | 54,15     | 56,41     | 70,51  |        |
| M 24x3,00   | 21,00   | D 130 x 45 x 18,00 x 14,00     | 61,17     | 63,72     | 79,64  |        |
| M 27x3,00   | 24,00   | D 135 x 45 x 20,00 x 16,00     | 75,33     | 78,47     | 98,09  |        |
| M 30x3,50   | 26,50   | D 138 x 48 x 20,00 x 16,00     | 111,92    | 116,59    | 145,73   |        |

**MACHINE TAPS DIN 352**

**M  
MF**

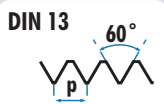

**HSS**

**HSSCo  
5%**

**DIN  
352**

**TOL  
6H**

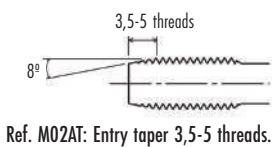
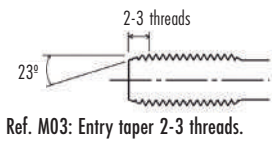

**D  
REDUCED  
SHANK**  
**DIN  
352**

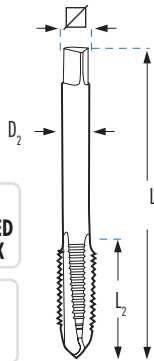

|  |  | $L_1 \times L_2 \times D_2 \times \square$<br>mm | M03      | M02AT                           | M03X               | M02DIN                | M04DIN  |
|---|---|--|----------|---------------------------------|--------------------|-----------------------|---|
|   |   |  | HSS<br>€ | COMPLETE<br>PROFILE<br>HSS<br>€ | INOX<br>HSSCo<br>€ | B<br>FORM<br>HSS<br>€ |  35°<br>HSS<br>€ |
| M 3x0,50  | 2,50  | D 40 x 11 x 3,50 x 2,70                          | 7,58     | 10,43                           | 13,53              | 9,84                  | 11,85   |
| M 4x0,70  | 3,30  | D 45 x 13 x 4,50 x 3,40                          | 7,57     | 10,42                           | 13,53              | 9,84                  | 11,85   |
| M 5x0,80  | 4,20  | D 50 x 16 x 6,00 x 4,90                          | 8,10     | 11,15                           | 14,09              | 9,84                  | 11,85   |
| M 6x1,00  | 5,00  | D 50 x 19 x 6,00 x 4,90                          | 8,10     | 11,15                           | 14,04              | 9,84                  | 12,11   |
| M 7x1,00  | 6,00  | D 50 x 19 x 6,00 x 4,90                          | 9,86     |                                 |                    |                       |   |
| M 8x1,00  | 7,00  | D 56 x 18 x 6,00 x 4,90                          | 13,65    |                                 |                    |                       |   |
| M 8x1,25  | 6,75  | D 56 x 22 x 6,00 x 4,90                          | 9,85     | 13,57                           | 16,34              | 13,14                 | 14,68   |
| M 9x1,25  | 7,75  | D 63 x 18 x 7,00 x 5,50                          | 16,14    |                                 |                    |                       |   |
| M 10x1,00   | 9,00  | D 63 x 18 x 7,00 x 5,50                          | 14,62    |                                 |                    |                       |   |
| M 10x1,25   | 8,80  | D 70 x 24 x 7,00 x 5,50                          | 14,82    |                                 |                    |                       |   |
| M 10x1,50   | 8,50  | D 70 x 24 x 7,00 x 5,50                          | 12,15    | 16,72                           | 21,03              | 16,71                 | 18,50   |
| M 12x1,00   | 11,00   | D 70 x 20 x 9,00 x 7,00                          | 25,91    |                                 |                    |                       |   |
| M 12x1,25   | 10,75   | D 70 x 20 x 9,00 x 7,00                          | 25,84    |                                 |                    |                       |   |
| M 12x1,50   | 10,50   | D 70 x 20 x 9,00 x 7,00                          | 22,02    |                                 |                    |                       |   |
| M 12x1,75   | 10,20   | D 75 x 29 x 9,00 x 7,00                          | 17,09    | 23,54                           | 30,11              | 21,48                 | 24,09   |
| M 14x1,00   | 13,00   | D 70 x 20 x 11,00 x 9,00                         | 40,39    |                                 |                    |                       |   |
| M 14x1,25   | 12,80   | D 70 x 20 x 11,00 x 9,00                         | 31,55    |                                 |                    |                       |   |
| M 14x1,50   | 12,50   | D 70 x 20 x 11,00 x 9,00                         | 24,53    |                                 |                    |                       |   |
| M 14x2,00   | 12,00   | D 80 x 30 x 11,00 x 9,00                         | 18,91    | 26,03                           | 33,34              | 25,67                 | 31,09   |
| M 16x1,00   | 15,00   | D 70 x 20 x 12,00 x 9,00                         | 53,58    |                                 |                    |                       |   |
| M 16x1,25   | 14,75   | D 70 x 20 x 12,00 x 9,00                         | 56,40    |                                 |                    |                       |   |
| M 16x1,50   | 14,50   | D 70 x 20 x 12,00 x 9,00                         | 30,53    |                                 |                    |                       |   |
| M 16x2,00   | 14,00   | D 80 x 32 x 12,00 x 9,00                         | 27,06    |                                 | 45,70              | 31,89                 | 36,05   |
| M 18x1,50   | 16,50   | D 80 x 22 x 14,00 x 11,00                        | 40,22    |                                 |                    |                       |   |
| M 18x2,50   | 15,50   | D 95 x 40 x 14,00 x 11,00                        | 35,71    |                                 | 62,41              | 48,01                 | 60,02   |
| M 20x1,50   | 18,50   | D 80 x 22 x 16,00 x 12,00                        | 50,37    |                                 |                    |                       |   |
| M 20x2,50   | 17,50   | D 95 x 40 x 16,00 x 12,00                        | 40,06    |                                 | 69,27              | 53,66                 | 67,07   |
| M 22x2,50   | 19,50   | D 100 x 40 x 18,00 x 14,50                       | 53,36    |                                 |                    | 62,03                 | 77,56   |
| M 24x3,00   | 21,00   | D 110 x 50 x 18,00 x 14,50                       | 63,65    |                                 |                    | 70,10                 | 87,61   |
| M 27x3,00   | 24,00   | D 110 x 50 x 20,00 x 16,00                       | 80,48    |                                 |                    | 90,48                 | 99,32   |
| M 30x3,50   | 26,50   | D 125 x 50 x 22,00 x 18,00                       | 103,55   |                                 |                    | 123,93                | 127,28  |

## MACHINE TAPS AND DIES *Plus & Super Plus*

### Plus

DIN 13

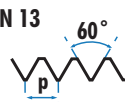

60°

**TOL**  
**6H**

FOR HIGH PRODUCTION WORKS  
HSS PM: POWDER STEEL

**DIN**  
**22568**

**TOL**  
**6g**



|                  |       | <i>Plus</i> |                        | <i>Plus TiN</i> |          | <i>Plus LUBE</i> |           | <i>Super Plus ALTiN</i> |        |           |        |         |        |
|------------------|-------|-------------|------------------------|-----------------|----------|------------------|-----------|-------------------------|--------|-----------|--------|---------|--------|
|                  |       | M2RP        | M4RP                   | M2RT            | M4RT     | M2RHL            | M4RHL     | M2RSP                   | M4RSP  | C5P       |        |         |        |
| QUALITY          |       | ★★          | ★★                     | ★★★             | ★★★      | ★★★★             | ★★★★      | ★★★                     | ★★★    |           |        |         |        |
| MATERIAL         |       | HSS PM      | HSS PM                 | HSSCo 5%        | HSSCo 5% | HSS PM           | HSS PM    | HSS V3                  | HSS V3 | HSS       |        |         |        |
| COATING          |       | BRIGHT      | BRIGHT                 | TiN             | TiN      | HARD LUBE        | HARD LUBE | ALTiN                   | ALTiN  | BRIGHT    |        |         |        |
| HELIX ANGLE      |       | B FORM      | 35°                    | B FORM          | 35°      | B FORM           | 35°       | B FORM                  | 41°    |           |        |         |        |
| L1 x L2 x D2 x ∅ |       | mm          | mm                     | mm              | mm       | mm               | mm        | mm                      | mm     | ∅ x L3 mm | €      |         |        |
|                  |       | €           | €                      | €               | €        | €                | €         | €                       | €      | €         | €      |         |        |
| M 3x0,50         | 2,50  | R           | 56 x 11 x 3,5 x 2,7    | 17,59           | 21,74    | 23,68            | 26,17     | 31,71                   | 34,32  | 42,61     | 44,59  | 25 x 9  | 32,36  |
| M 4x0,70         | 3,30  | R           | 63 x 13 x 4,5 x 3,4    | 17,97           | 21,74    | 24,06            | 27,29     | 32,19                   | 34,80  | 42,61     | 44,59  | 25 x 9  | 32,36  |
| M 5x0,80         | 4,20  | R           | 70 x 16 x 6,0 x 4,9    | 17,97           | 20,83    | 24,06            | 27,29     | 32,19                   | 34,80  | 45,00     | 46,25  | 25 x 9  | 32,36  |
| M 6x1,00         | 5,00  | R           | 80 x 17 x 6,0 x 4,9    | 19,76           | 22,88    | 27,70            | 30,00     | 35,34                   | 36,84  | 45,00     | 46,25  | 25 x 9  | 32,36  |
| M 8x1,00         | 7,00  | D           | 90 x 20 x 6,0 x 4,9    | 28,20           | 33,46    | 39,71            | 44,19     | 53,61                   | 59,67  |           |        | 25 x 9  | 45,13  |
| M 8x1,25         | 6,80  | R           | 90 x 20 x 8,0 x 6,2    | 23,13           | 26,58    | 32,38            | 35,22     | 44,94                   | 46,88  | 57,13     | 60,88  | 25 x 9  | 35,10  |
| M 10x1,00        | 9,00  | D           | 90 x 16 x 7,0 x 5,5    | 31,44           | 39,42    | 46,39            | 53,26     | 62,60                   | 73,96  |           |        | 30 x 10 | 55,16  |
| M 10x1,50        | 8,50  | R           | 100 x 22 x 10,0 x 8,0  | 27,22           | 30,94    | 38,14            | 41,76     | 55,73                   | 58,34  | 68,08     | 72,63  | 30 x 10 | 48,27  |
| REDUCED SHANK    |       | M2DP        | M4DP                   | M2DT            | M4DT     | M2DHL            | M4DHL     | M2DSP                   | M4DSP  |           |        |         |        |
| M 12x1,50        | 10,50 | D           | 100 x 22 x 9,0 x 7,0   | 37,30           | 45,09    | 50,24            | 56,56     | 67,52                   | 77,44  |           |        | 38 x 10 | 57,34  |
| M 12x1,75        | 10,20 | D           | 110 x 24 x 9,0 x 7,0   | 35,08           | 41,66    | 47,02            | 53,01     | 58,83                   | 70,61  | 85,66     | 92,93  | 38 x 14 | 50,63  |
| M 14x1,50        | 12,50 | D           | 100 x 22 x 11,0 x 9,0  | 44,19           | 55,42    | 59,08            | 65,26     | 79,41                   | 91,07  |           |        | 38 x 10 | 59,94  |
| M 14x2,00        | 12,00 | D           | 110 x 26 x 11,0 x 9,0  | 43,86           | 50,84    | 58,02            | 63,79     | 80,25                   | 88,21  | 87,45     | 117,75 | 38 x 14 | 51,61  |
| M 16x1,50        | 14,50 | D           | 100 x 22 x 12,0 x 9,0  | 55,28           | 68,16    | 71,01            | 81,19     | 78,41                   | 91,53  |           |        | 45 x 14 | 82,34  |
| M 16x2,00        | 14,00 | D           | 110 x 27 x 12,0 x 9,0  | 51,58           | 61,45    | 66,24            | 73,23     | 91,62                   | 101,26 | 119,37    | 126,99 | 45 x 18 | 69,33  |
| M 18x2,50        | 15,50 | D           | 125 x 30 x 14,0 x 11,0 | 73,11           | 82,59    | 90,46            | 98,69     | 129,43                  | 137,52 | 177,19    | 191,70 | 45 x 18 | 69,33  |
| M 20x2,50        | 17,50 | D           | 140 x 32 x 16,0 x 12,0 | 78,99           | 88,04    | 103,10           | 111,07    | 135,99                  | 154,83 | 188,84    | 199,61 | 45 x 18 | 69,33  |
| M 22x2,50        | 19,50 | D           | 140 x 32 x 18,0 x 14,5 | 95,56           | 108,64   | 116,52           | 124,72    | 159,50                  | 174,05 |           |        | 55 x 22 | 103,06 |
| M 24x3,00        | 21,00 | D           | 160 x 34 x 18,0 x 14,5 | 113,62          | 130,06   | 131,29           | 142,66    | 179,72                  | 199,07 |           |        | 55 x 22 | 103,06 |

\* Vc: Cutting Speed (m/min)

**POWDER STEEL MACHINE TAPS FOR STAINLESS STEEL**

**INOX**

**M**

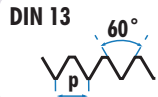

**TOL  
6H**

**Vc  
6 m/min**

**Vc  
10 m/min**

**Vc  
12 m/min**

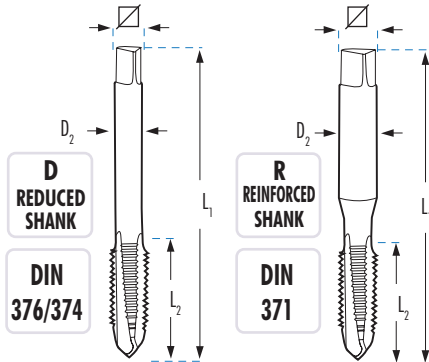

|                      |     |      |  | M2RX      | M4RX      | M2RXT       | M4RXT       | M2RXHL    | M4RXHL    |
|----------------------|-----|------|--|-----------|-----------|-------------|-------------|-----------|-----------|
| <b>QUALITY</b>       |     |      |  | ★★        | ★★        | ★★★         | ★★★         | ★★★★      | ★★★★      |
| <b>MATERIAL</b>      |     |      |  | HSS<br>PM | HSS<br>PM | HSSCo<br>5% | HSSCo<br>5% | HSS<br>PM | HSS<br>PM |
| <b>COATING</b>       |     |      |  | OX        | OX        | TIN         | TIN         | HARD LUBE | HARD LUBE |
| <b>HELIX ANGLE</b>   |     |      |  | B<br>FORM | 35°       | B<br>FORM   | 35°         | B<br>FORM | 35°       |
|                      |     |      | L <sub>1</sub> x L <sub>2</sub> x D <sub>2</sub> x ∅<br>mm | €         | €         | €           | €           | €         | €         |
| M                    | 3x  | 0,50 | 2,50 R 56 x 11 x 3,5 x 2,7                                 | 21,02     | 24,98     | 24,28       | 27,47       | 32,11     | 37,76     |
| M                    | 4x  | 0,70 | 3,30 R 63 x 13 x 4,5 x 3,4                                 | 22,07     | 24,98     | 25,46       | 27,92       | 33,73     | 38,75     |
| M                    | 5x  | 0,80 | 4,20 R 70 x 16 x 6,0 x 4,9                                 | 22,07     | 25,17     | 25,46       | 28,34       | 33,73     | 39,33     |
| M                    | 6x  | 1,00 | 5,00 R 80 x 17 x 6,0 x 4,9                                 | 24,18     | 27,22     | 26,96       | 29,63       | 36,93     | 41,15     |
| M                    | 8x  | 1,00 | 7,00 D 90 x 20 x 6,0 x 4,9                                 | 39,04     | 42,78     |             |             |           |           |
| M                    | 8x  | 1,25 | 6,80 R 90 x 20 x 8,0 x 6,2                                 | 26,97     | 31,01     | 31,16       | 34,14       | 41,23     | 47,39     |
| M                    | 10x | 1,00 | 9,00 D 90 x 16 x 7,0 x 5,5                                 | 40,24     | 42,96     |             |             |           |           |
| M                    | 10x | 1,50 | 8,50 R 100 x 22 x 10,0 x 8,0                               | 32,99     | 36,79     | 36,44       | 40,26       | 50,38     | 56,20     |
| <b>REDUCED SHANK</b> |     |      |  | M2DX      | M4DX      | M2DXT       | M4DXT       | M2DXHL    | M4DXHL    |
| M                    | 12x | 1,00 | 11,00 D 100 x 22 x 9,0 x 7,0                               | 45,63     | 52,35     |             |             |           |           |
| M                    | 12x | 1,50 | 10,50 D 100 x 22 x 9,0 x 7,0                               | 46,32     | 54,77     |             |             |           |           |
| M                    | 12x | 1,75 | 10,20 D 110 x 24 x 9,0 x 7,0                               | 42,39     | 49,63     | 46,61       | 52,47       | 66,34     | 77,66     |
| M                    | 14x | 2,00 | 12,00 D 110 x 26 x 11,0 x 9,0                              | 60,34     | 69,12     | 60,72       | 65,64       | 88,15     | 97,61     |
| M                    | 16x | 2,00 | 14,00 D 110 x 27 x 12,0 x 9,0                              | 67,20     | 79,77     | 68,92       | 75,53       | 98,14     | 118,06    |
| M                    | 18x | 2,50 | 15,50 D 125 x 30 x 14,0 x 11,0                             | 100,63    | 113,51    | 103,90      | 107,81      | 157,49    | 167,97    |
| M                    | 20x | 2,50 | 17,50 D 140 x 32 x 16,0 x 12,0                             | 108,75    | 119,87    | 118,63      | 121,80      | 167,43    | 177,36    |
| M                    | 22x | 2,50 | 19,50 D 140 x 32 x 18,0 x 14,5                             | 130,49    | 137,88    | 147,26      | 159,44      |           |           |
| M                    | 24x | 3,00 | 21,00 D 160 x 34 x 18,0 x 14,5                             | 137,19    | 157,47    | 150,13      | 163,09      |           |           |
| M                    | 27x | 3,00 | 24,00 D 160 x 36 x 20,0 x 16,0                             | 179,71    | 206,27    |             |             |           |           |
| M                    | 30x | 3,50 | 26,50 D 180 x 40 x 22,0 x 18,0                             | 229,81    | 263,78    |             |             |           |           |

\* Vc: Cutting Speed (m/min)



- **CUT MAGIC XTHICK** Coolant
- We recommend using **CUT MAGIC XTHICK** to optimize the threading in stainless steel, inconel, titanium, etc.

Ref. ACXT00250

## Super Plus TAPS FOR THREADING REFRACTORY ALLOYS

Threading tools

Pink

**M** **DIN 13** **60°** **TOL 6H** **INOX DUPLEX** **Ni** **INC** **Ti**

SPECIALLY RECOMMENDED FOR AERONAUTICAL APPLICATIONS



|                      |  |                          | M2RDU        | M4RDU        | M2RNI        | M3RNI        | M2RTIT        | M3RTIT        |
|----------------------|--|--------------------------|--------------|--------------|--------------|--------------|---------------|---------------|
| QUALITY              |  |                          | ★★★★         | ★★★★         | ★★★★         | ★★★★         | ★★★★          | ★★★★          |
| MATERIAL             |  |                          | HSS V3       | HSS V3       | HSS PM       | HSS PM       | HSS PM        | HSS PM        |
| COATING              |  |                          | TiCN         | TiCN         | BRIGHT       | BRIGHT       | OX            | OX            |
| HELIX ANGLE          |  |                          | B FORM       | 41°          | B FORM       | 15°          | B FORM        | 15°           |
|                      |  |                          | €            | €            | €            | €            | €             | €             |
|                      | $L_1 \times L_2 \times D_2 \times \varnothing$<br>mm |                          |              |              |              |              |               |               |
| M 3x0,50             | 2,50   | R 56 x 11 x 3,5 x 2,7    | 43,21        | 44,26        | 80,27        | 82,03        | 59,60         | 65,78         |
| M 4x0,70             | 3,30   | R 63 x 13 x 4,5 x 3,4    | 43,21        | 44,53        | 82,03        | 84,25        | 61,46         | 65,78         |
| M 5x0,80             | 4,20   | R 70 x 16 x 6,0 x 4,9    | 44,66        | 45,53        | 84,92        | 86,93        | 63,01         | 70,07         |
| M 6x1,00             | 5,00   | R 80 x 17 x 6,0 x 4,9    | 45,89        | 46,86        | 85,59        | 88,01        | 63,01         | 71,04         |
| M 8x1,25             | 6,80   | R 90 x 20 x 8,0 x 6,2    | 64,09        | 66,82        | 96,73        | 99,30        | 72,81         | 82,03         |
| M 10x1,50            | 8,50   | R 100 x 22 x 10,0 x 8,0  | 83,07        | 85,23        | 114,92       | 118,44       | 90,17         | 98,85         |
| <b>REDUCED SHANK</b> |  |                          | <b>M2DDU</b> | <b>M4DDU</b> | <b>M2DNI</b> | <b>M3DNI</b> | <b>M2DTIT</b> | <b>M3DTIT</b> |
| M 12x1,75            | 10,20  | D 110 x 24 x 9,0 x 7,0   | 112,30       | 121,26       | 147,82       | 163,44       | 113,17        | 122,81        |
| M 14x2,00            | 12,00  | D 110 x 26 x 11,0 x 9,0  |              |              |              |              |               |               |
| M 16x2,00            | 14,00  | D 110 x 27 x 12,0 x 9,0  | 165,14       | 176,59       |              |              |               |               |
| M 18x2,50            | 15,50  | D 125 x 30 x 14,0 x 11,0 |              |              |              |              |               |               |
| M 20x2,50            | 17,50  | D 140 x 32 x 16,0 x 12,0 | 244,53       | 264,13       |              |              |               |               |
| M 22x2,50            | 19,50  | D 140 x 32 x 18,0 x 14,5 |              |              |              |              |               |               |
| M 24x3,00            | 21,00  | D 160 x 34 x 18,0 x 14,5 | 331,21       | 336,89       |              |              |               |               |
| M 27x3,00            | 24,00  | D 160 x 36 x 20,0 x 16,0 | 425,51       | 446,03       |              |              |               |               |
| M 30x3,50            | 26,50  | D 180 x 40 x 22,0 x 18,0 | 502,54       | 525,85       |              |              |               |               |

\* Vc: Cutting Speed (m/min)

**MACHINE TAPS FOR SUPER SOFT CONSTRUCTION STEEL <450 N/mm<sup>2</sup>**

DIN 13

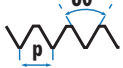

**HSSCo**  
5%

**OX**

**TOL**  
6H

APPLICATIONS



**450**  
N/mm<sup>2</sup>

**ST52**

**Al**

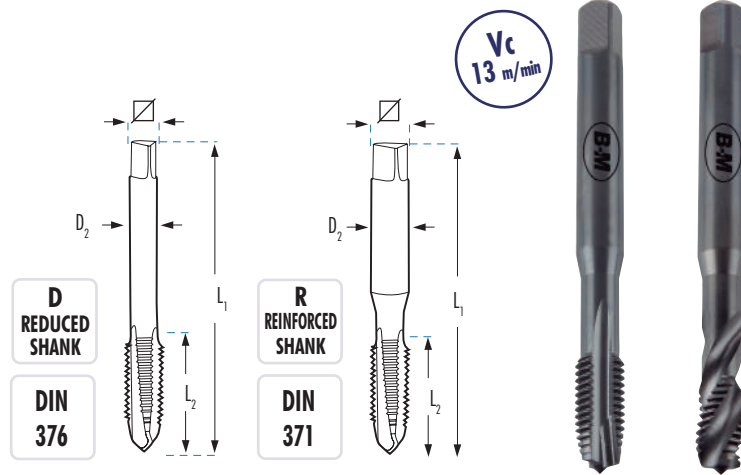
Specific cutting geometry for soft materials without oversize. The tap fits perfectly with this type of materials while the conventional taps can generate oversize when tapping.



|  | <br>Ø | L <sub>1</sub> x L <sub>2</sub> x D <sub>2</sub> x <br>mm | M2RSS  | M4RSS  |
|---|--|--|--------|--------|
|   |  |  | B FORM | 35°    |
|   |  |  | €      | €      |
| M 3 x 0,50  | 2,50   | R 56 x 11 x 3,5 x 2,7  | 14,97  | 20,00  |
| M 4 x 0,70  | 3,30   | R 63 x 13 x 4,5 x 3,4  | 15,67  | 20,01  |
| M 5 x 0,80  | 4,20   | R 70 x 16 x 6,0 x 4,9  | 15,69  | 19,19  |
| M 6 x 1,00  | 5,00   | R 80 x 17 x 6,0 x 4,9  | 17,21  | 21,04  |
| M 8 x 1,25  | 6,80   | R 90 x 20 x 8,0 x 6,2  | 19,31  | 23,80  |
| M 10 x 1,50   | 8,50   | R 100 x 22 x 10,0 x 8,0  | 23,78  | 28,19  |
| REDUCED SHANK   |  |  | M2DSS  | M4DSS  |
| M 12 x 1,75   | 10,20  | D 110 x 24 x 9,0 x 7,0   | 29,99  | 36,31  |
| M 14 x 2,00   | 12,00  | D 110 x 26 x 11,0 x 9,0  | 44,28  | 52,29  |
| M 16 x 2,00   | 14,00  | D 110 x 27 x 12,0 x 9,0  | 51,79  | 63,17  |
| M 18 x 2,50   | 15,50  | D 125 x 30 x 14,0 x 11,0   | 73,77  | 81,89  |
| M 20 x 2,50   | 17,50  | D 140 x 32 x 16,0 x 12,0   | 79,63  | 90,78  |
| M 22 x 2,50   | 19,50  | D 140 x 32 x 18,0 x 14,5   | 95,59  | 106,53 |
| M 24 x 3,00   | 21,00  | D 160 x 34 x 18,0 x 14,5   | 113,86 | 129,49 |
| M 27 x 3,00   | 24,00  | D 160 x 36 x 20,0 x 16,0   | 142,41 | 159,32 |
| M 30 x 3,50   | 26,50  | D 180 x 40 x 22,0 x 18,0   | 182,98 | 204,17 |

\* Vc: Cutting Speed (m/min)

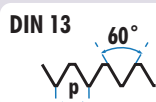
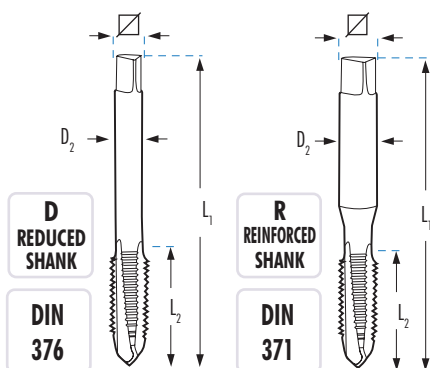
**HSSV3 MACHINE TAPS FOR HARD MATERIALS**

**HSS  
V3**
**TOL  
6H**
**HARD  
MATERIALS**

**Vc  
7 m/min**
**Vc  
9 m/min**

|   |         |                             |                          | M2RMD  | M4RMD  | M2RMDTX | M4RMDTX |
|---|---------|-----------------------------|--------------------------|--------|--------|---------|---------|
|   |         | QUALITY                     |                          | ★★★    | ★★★    | ★★★★    | ★★★★    |
|   |         | MATERIAL                    |                          | HSS V3 | HSS V3 | HSS V3  | HSS V3  |
|   |         | COATING                     |                          | OX     | OX     | TINALOX | TINALOX |
|   |         | HELIX ANGLE                 |                          | B FORM | 35°    | B FORM  | 35°     |
|   |         | L1 x L2 x D2 x $\square$ mm |                          | €      | €      | €       | €       |
| M | 3x0,50  | 2,50                        | R 56 x 11 x 3,5 x 2,7    | 18,45  | 20,20  | 27,06   | 31,82   |
| M | 4x0,70  | 3,30                        | R 63 x 13 x 4,5 x 3,4    | 18,51  | 20,27  | 28,43   | 33,32   |
| M | 5x0,80  | 4,20                        | R 70 x 16 x 6,0 x 4,9    | 18,51  | 21,26  | 28,43   | 33,32   |
| M | 6x1,00  | 5,00                        | R 80 x 17 x 6,0 x 4,9    | 21,01  | 21,97  | 31,14   | 35,04   |
| M | 8x1,25  | 6,80                        | R 90 x 20 x 8,0 x 6,2    | 22,45  | 25,92  | 34,76   | 39,95   |
| M | 10x1,50 | 8,50                        | R 100 x 22 x 10,0 x 8,0  | 25,86  | 29,85  | 43,98   | 49,06   |
|   |         | REDUCED SHANK               |                          | M2DMD  | M4DMD  | M2DMDTX | M4DMDTX |
| M | 12x1,75 | 10,20                       | D 110 x 24 x 9,0 x 7,0   | 36,87  | 42,53  | 58,58   | 68,58   |
| M | 14x2,00 | 12,00                       | D 110 x 26 x 11,0 x 9,0  | 48,36  | 50,48  | 83,35   | 91,52   |
| M | 16x2,00 | 14,00                       | D 110 x 27 x 12,0 x 9,0  | 54,10  | 61,08  | 92,84   | 110,68  |
| M | 18x2,50 | 15,50                       | D 125 x 30 x 14,0 x 11,0 | 80,66  | 86,89  | 136,50  | 154,58  |
| M | 20x2,50 | 17,50                       | D 140 x 32 x 16,0 x 12,0 | 87,17  | 91,74  | 147,53  | 163,18  |

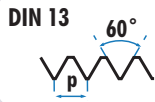
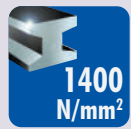
\* Vc: Cutting Speed (m/min)

**MACHINE TAPS FOR HARDENED MATERIALS (HARDOX 450/500)**



**TOL  
6H**

**HSSE**

**HSS  
PM**

**SOLID  
CARBIDE**

**VERY HARD  
MATERIALS**

**48  
HRc**

**48-62  
HRc**

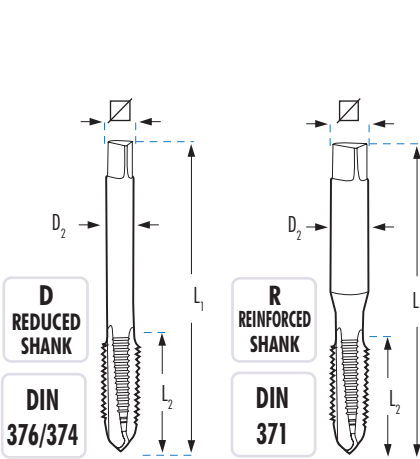

**Vc  
5 m/min**



**SOLID  
CARBIDE**

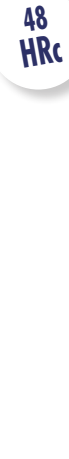

| MATERIAL      | COATING | FORM                     | M2RC   |        | M3RC    |         | M2HRC  |          | M4HRC         |               | M1RCM  |        | M1RHMC |   |
|---------------|---------|--------------------------|--------|--------|---------|---------|--------|----------|---------------|---------------|--------|--------|--------|---|
|               |         |                          | HSSE   | HSSE   | HSS PM  | HSS PM  | HSS PM | HSS PM   | SOLID CARBIDE | SOLID CARBIDE |        |        |        |   |
|               |         |                          | TiAIN  | TiAIN  | TINALOX | TINALOX |        |          |               |               | TiCN   | TiCN   |        |   |
|               |         |                          | B FORM | 15°    | B FORM  | 35°     |        |          |               |               | C FORM | C FORM |        |   |
|               |         | L1 x L2 x D2 x mm        | €      | €      | €       | €       | €      | €        | €             | €             | €      | €      | €      | € |
| M 3 x 0,50    | 2,50    | R 56 x 11 x 3,5 x 2,7    | 29,52  | 31,40  | 32,64   | 36,56   | 2,60   | 47,28    | 2,60          | 130,98        |        |        |        |   |
| M 4 x 0,70    | 3,30    | R 63 x 13 x 4,5 x 3,4    | 29,58  | 33,44  | 33,90   | 37,97   | 3,40   | 41,59    | 3,40          | 130,98        |        |        |        |   |
| M 5 x 0,80    | 4,20    | R 70 x 16 x 6,0 x 4,9    | 29,86  | 32,68  | 34,23   | 38,34   | 4,30   | 46,47    | 4,30          | 130,98        |        |        |        |   |
| M 6 x 1,00    | 5,00    | R 80 x 17 x 6,0 x 4,9    | 32,28  | 36,18  | 35,69   | 39,97   | 5,10   | 59,50    | 5,10          | 163,73        |        |        |        |   |
| M 8 x 1,25    | 6,80    | R 90 x 20 x 8,0 x 6,2    | 37,28  | 42,54  | 44,37   | 49,71   | 6,90   | 66,00    | 6,90          | 184,26        |        |        |        |   |
| M 10 x 1,50   | 8,50    | R 100 x 22 x 10,0 x 8,0  | 44,63  | 52,70  | 53,11   | 55,77   | 8,60   | 85,56    | 8,60          | 282,73        |        |        |        |   |
| REDUCED SHANK |         |                          | M2DC   | M3DC   | M2HDC   | M4HDC   | M1RCM  |          | M1DHMC        |               |        |        |        |   |
| M 12 x 1,75   | 10,20   | D 110 x 24 x 9,0 x 7,0   | 66,74  | 79,22  | 81,07   | 88,38   | 10,40  | 113,20 * | 10,40         | 442,80        |        |        |        |   |
| M 14 x 2,00   | 12,00   | D 110 x 26 x 11,0 x 9,0  | 90,11  | 105,40 | 96,14   | 108,13  | 12,10  | 143,12 * | 12,10         | 510,23        |        |        |        |   |
| M 16 x 2,00   | 14,00   | D 110 x 27 x 12,0 x 9,0  | 101,67 | 121,07 | 106,89  | 123,95  | 14,10  | 153,09 * | 16,10         | 666,25        |        |        |        |   |
| M 18 x 2,50   | 15,50   | D 125 x 30 x 14,0 x 11,0 | 128,75 | 140,20 | 132,32  | 144,23  |        |          | 15,75         | 813,95        |        |        |        |   |
| M 20 x 2,50   | 17,50   | D 140 x 32 x 16,0 x 12,0 | 155,93 | 162,29 | 156,26  | 170,33  |        |          | 17,75         | 1.287,53      |        |        |        |   |
| M 22 x 2,50   | 19,50   | D 140 x 32 x 18,0 x 14,5 | 220,88 | 230,33 |         |         |        |          |               |               |        |        |        |   |
| M 24 x 3,00   | 21,00   | D 160 x 34 x 18,0 x 14,5 | 226,13 | 236,63 | 235,97  | 257,22  |        |          |               |               |        |        |        |   |
| M 27 x 3,00   | 24,00   | D 160 x 36 x 20,0 x 16,0 | 236,63 | 254,48 |         |         |        |          |               |               |        |        |        |   |
| M 30 x 3,50   | 26,50   | D 180 x 40 x 22,0 x 18,0 | 253,31 | 268,13 |         |         |        |          |               |               |        |        |        |   |

\* Vc: Cutting Speed (m/min)

\* Reinforced shank: M12 - Ø 12 x 9  
M14 - Ø 14 x 11  
M16 - Ø 16 x 12



- **CUT MAGIC XTHICK** Coolant
- We recommend using the same machine and exact position as the one used during prior drilling to ensure perfect coaxiality.

Ref. ACXT00250

| HRc    | Vc (m/min) |
|--------|------------|
| 48 Hrc | 8 m/min    |
| 56 Hrc | 6 m/min    |
| 62 Hrc | 3 m/min    |

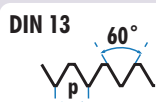
**ALL ROAD MACHINE TAPS FOR THREADING ANY MATERIAL**
**ALL  
ROAD**

**HSSCo**  
5%

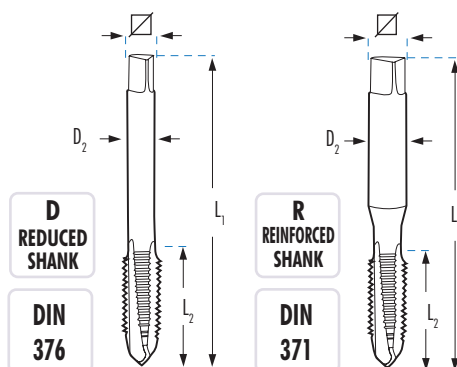
**TiN**
**TOL**  
6H

**APPLICATIONS**
**1200**  
N/mm<sup>2</sup>
**Al**
**CAST  
IRON**
**Ti**
**INOX**
**Vc**  
13 m/min

|                      |       | L1 x L2 x D2 x $\square$<br>mm | M2RD           | M4RD        |
|----------------------|-------|--------------------------------|----------------|-------------|
|                      |       |                                | B<br>FORM<br>€ | 35°<br>€    |
| M 3 x 0,50           | 2,50  | R 56 x 11 x 3,5 x 2,7          | 27,71          | 34,64       |
| M 4 x 0,70           | 3,30  | R 63 x 13 x 4,5 x 3,4          | 29,65          | 34,64       |
| M 5 x 0,80           | 4,20  | R 70 x 16 x 6,0 x 4,9          | 31,54          | 35,88       |
| M 6 x 1,00           | 5,00  | R 80 x 17 x 6,0 x 4,9          | 32,64          | 37,24       |
| M 8 x 1,25           | 6,80  | R 90 x 20 x 8,0 x 6,2          | 38,24          | 42,49       |
| M 10 x 1,50          | 8,50  | R 100 x 22 x 10,0 x 8,0        | 44,12          | 50,34       |
| <b>REDUCED SHANK</b> |       |                                | <b>M2DD</b>    | <b>M4DD</b> |
| M 12 x 1,75          | 10,20 | D 110 x 24 x 9,0 x 7,0         | 55,60          | 66,19       |
| M 14 x 2,00          | 12,00 | D 110 x 26 x 11,0 x 9,0        | 72,61          | 79,79       |
| M 16 x 2,00          | 14,00 | D 110 x 27 x 12,0 x 9,0        | 81,36          | 88,06       |
| M 18 x 2,50          | 15,50 | D 125 x 30 x 14,0 x 11,0       | 127,14         | 130,38      |
| M 20 x 2,50          | 17,50 | D 140 x 32 x 16,0 x 12,0       | 129,51         | 134,36      |

\* Vc: Cutting Speed (m/min)

**HSSCo & CARBIDE MACHINE TAPS FOR SPECIAL APPLICATIONS**

Threading tools

Pink

**Al**

**CAST IRON**

**BRASS**

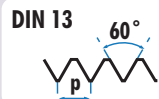

**HSSCo**  
5%

**SOLID CARBIDE**

**TOL**  
6H

**Vc**  
18 m/min

**Vc**  
11 m/min

**Vc**  
21 m/min

**Vc**  
16 m/min

**Vc**  
19 m/min

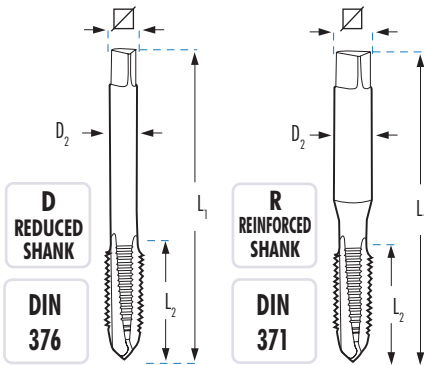

|                            |       |                          | M5R                | M6R      | M1RFM     | M1RFR         | M1RL     | M1RLCRN  |
|----------------------------|-------|--------------------------|--------------------|----------|-----------|---------------|----------|----------|
| APPLICATION                |       |                          | Al                 | Al       | CAST IRON | CAST IRON     | BRASS    | BRASS    |
| MATERIAL                   |       |                          | HSSCo 5%           | HSSCo 5% | HSSCo 5%  | SOLID CARBIDE | HSSCo 5% | HSSCo 5% |
| COATING                    |       |                          | BRIGHT             | BRIGHT   | OX        | BRIGHT        | BRIGHT   | CrN      |
| FORM                       |       |                          | INTERRUPTED THREAD | 2 FLUTES | C FORM    | C FORM        | C FORM   | C FORM   |
| L1 x L2 x D2 x $\nabla$ mm |       |                          | €                  | €        | €         | €             | €        | €        |
| M 3x0,50                   | 2,50  | R 56 x 11 x 3,5 x 2,7    | 23,91              | 25,65    | 16,92     | 85,74         | 20,25    | 23,01    |
| M 4x0,70                   | 3,30  | R 63 x 13 x 4,5 x 3,4    | 24,05              | 25,65    | 17,48     | 85,74         | 21,50    | 25,36    |
| M 5x0,80                   | 4,20  | R 70 x 16 x 6,0 x 4,9    | 23,91              | 26,20    | 17,48     | 85,74         | 21,50    | 25,45    |
| M 6x1,00                   | 5,00  | R 80 x 17 x 6,0 x 4,9    | 25,20              | 28,33    | 19,86     | 97,80         | 23,56    | 27,79    |
| M 8x1,25                   | 6,80  | R 90 x 20 x 8,0 x 6,2    | 30,17              | 33,95    | 22,24     | 109,20        | 26,87    | 33,79    |
| M 10x1,50                  | 8,50  | R 100 x 22 x 10,0 x 8,0  | 36,37              | 40,14    | 25,44     | 136,86        | 32,32    | 41,12    |
| REDUCED SHANK              |       |                          | M5D                | M6D      | M1DFM     | M1DFR         | M1DL     | M1DLCRN  |
| M 12x1,75                  | 10,20 | D 110 x 24 x 9,0 x 7,0   | 46,23              | 50,45    | 32,60     | 190,92        | 38,42    | 50,63    |
| M 14x2,00                  | 12,00 | D 110 x 26 x 11,0 x 9,0  | 83,72              | 87,13    | 53,59     | 297,42        | 47,17    | 61,70    |
| M 16x2,00                  | 14,00 | D 110 x 27 x 12,0 x 9,0  | 91,25              | 98,81    | 63,05     | 353,84        | 54,26    | 68,99    |
| M 18x2,50                  | 15,50 | D 125 x 30 x 14,0 x 11,0 |                    |          | 88,20     | 433,74        | 71,17    | 87,37    |
| M 20x2,50                  | 17,50 | D 140 x 32 x 16,0 x 12,0 |                    |          | 88,55     | 525,24        | 79,88    | 97,27    |

\* Vc: Cutting Speed (m/min)



- **CUT MAGIC ALUMINIUM** Coolant
- We recommend using CUT MAGIC ALUMINIUM to optimize the aluminium and its casts threading

Ref. ACAL00250

Threading tools

Pink

**FORMING MACHINE TAPS WITH & WITHOUT OIL GROOVES**



**FORMING**

DIN 13 + 60°

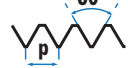

**HSSCo**  
5%

**HSSCo**  
8%

**TOL**  
6HX

APPLICATIONS



800  
N/mm<sup>2</sup>

Al









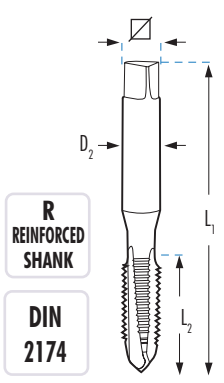





CAST  
IRON

+

INOX

Plus



|   |   |                                |                       | M07R  | M07RT   | M07RCR   | M07RCCR   | M09RCCR   | M07RXTCR  |
|---|---|--------------------------------|-----------------------|---|---|--|---|---|---|
|   |   | APPLICATION                    |                       |  |  |  |  |  |  |
|   |   | MATERIAL                       |                       | HSSCo<br>5%   | HSSCo<br>5%   | HSSCo<br>5%  | HSSCo<br>5%   | HSSCo<br>8%   | HSSCo<br>5%   |
|   |   | COATING                        |                       | OX  | TiN   | OX   | TiCN  | TiCN  | TiN   |
|   |   | FORM                           |                       |  |  |  |  |  |  |
|  |  | L1 x L2 x D2 x $\square$<br>mm |                       | €   | €   | €  | €   | €   | €   |
| M 3x0,50  | 2,75  | R                              | 56 x 11 x 3,5 x 2,7   | 33,82   | 36,72   | 37,22  | 46,70   | 112,36  | 83,79   |
| M 3,5x0,60  | 3,20  | R                              | 56 x 11 x 3,5 x 2,7   | 35,55   | 40,49   | 38,45  | 49,43   |   |   |
| M 4x0,70  | 3,65  | R                              | 63 x 13 x 4,5 x 3,4   | 33,82   | 38,29   | 37,22  | 48,71   | 113,78  | 83,79   |
| M 5x0,80  | 4,60  | R                              | 70 x 16 x 6,0 x 4,9   | 33,82   | 38,29   | 37,22  | 48,71   | 115,29  | 90,43   |
| M 6x1,00  | 5,50  | R                              | 80 x 17 x 6,0 x 4,9   | 36,52   | 40,47   | 40,16  | 51,48   | 117,12  | 90,43   |
| M 8x1,25  | 7,40  | R                              | 90 x 20 x 8,0 x 6,2   | 42,56   | 53,41   | 46,82  | 67,97   | 129,92  | 108,22  |
| M 10x1,50   | 9,30  | R                              | 100 x 22 x 10,0 x 8,0 | 47,33   | 59,89   | 52,08  | 74,80   | 155,12  | 132,12  |

|           |       | REDUCED SHANK |                        | M07D   | M07DT  | M07DCR | M07DCCR | M09DCCR | M07DXTCR |
|-----------|-------|---------------|------------------------|--------|--------|--------|---------|---------|----------|
|           |       | D             |                        |        |        |        |         |         |          |
| M 12x1,75 | 11,20 | D             | 110 x 24 x 9,0 x 7,0   | 55,79  | 78,32  | 59,09  | 85,66   | 183,62  | 172,05   |
| M 14x2,00 | 13,05 | D             | 110 x 26 x 11,0 x 9,0  | 100,57 | 123,69 | 104,48 | 139,06  | 228,52  | 247,51   |
| M 16x2,00 | 15,05 | D             | 110 x 27 x 12,0 x 9,0  | 118,06 | 139,31 | 122,63 | 147,21  | 314,30  | 251,80   |
| M 18x2,50 | 16,80 | D             | 125 x 30 x 14,0 x 11,0 | 135,48 | 166,58 | 140,72 | 173,94  | 372,40  |          |
| M 20x2,50 | 18,80 | D             | 140 x 32 x 16,0 x 12,0 | 178,51 | 252,17 | 185,43 | 264,43  | 412,29  |          |

**MACHINE TAPS WITH SPECIAL TOLERANCE AND OVERSIZE**





|           |       | M2R4H                    | M4R4H    | M2R6G    | M4R6G    | M2R7G    | M4R7G    | M2R+0,1       | M4R+0,1       | M2R+0,2       | M4R+0,2       |       |
|-----------|-------|--------------------------|----------|----------|----------|----------|----------|---------------|---------------|---------------|---------------|-------|
|           |       | TOL 4H                   | TOL 4H   | TOL 6G   | TOL 6G   | TOL 7G   | TOL 7G   | TOL 6H (+0,1) | TOL 6H (+0,1) | TOL 6H (+0,2) | TOL 6H (+0,2) |       |
|           |       | HSSCo 5%                 | HSSCo 5% | HSSCo 5% | HSSCo 5% | HSSCo 5% | HSSCo 5% | HSSCo 5%      | HSSCo 5%      | HSSCo 5%      | HSSCo 5%      |       |
|           |       | BRIGHT                   | BRIGHT   | BRIGHT   | BRIGHT   | BRIGHT   | BRIGHT   | BRIGHT        | BRIGHT        | BRIGHT        | BRIGHT        |       |
|           |       | B FORM                   | 35°      | B FORM   | 35°      | B FORM   | 35°      | B FORM        | 35°           | B FORM        | 35°           |       |
|           |       | €                        | €        | €        | €        | €        | €        | €             | €             | €             | €             |       |
| M 3x0,50  | 2,50  | R 56 x 11 x 3,5 x 2,7    | 23,14    | 28,61    | 16,98    | 20,20    | 23,14    | 28,61         | 23,89         | 31,87         | 27,41         | 33,94 |
| M 4x0,70  | 3,30  | R 63 x 13 x 4,5 x 3,4    | 23,68    | 28,61    | 16,98    | 20,20    | 23,68    | 28,61         | 24,45         | 31,87         | 28,04         | 33,94 |
| M 5x0,80  | 4,20  | R 70 x 16 x 6,0 x 4,9    | 23,68    | 27,42    | 16,98    | 19,82    | 23,68    | 27,42         | 24,45         | 30,52         | 28,04         | 32,49 |
| M 6x1,00  | 5,00  | R 80 x 17 x 6,0 x 4,9    | 26,02    | 30,08    | 18,28    | 21,77    | 26,02    | 30,08         | 26,85         | 33,50         | 30,82         | 35,66 |
| M 8x1,00  | 7,00  | D 90 x 20 x 6,0 x 4,9    |          |          | 35,60    | 39,36    |          |               |               |               |               |       |
| M 8x1,25  | 6,75  | R 90 x 20 x 8,0 x 6,2    | 29,14    | 34,35    | 21,25    | 25,52    | 29,14    | 34,35         | 30,08         | 38,22         | 34,52         | 40,71 |
| M 10x1,00 | 9,00  | D 90 x 16 x 7,0 x 5,5    |          |          | 42,04    | 48,93    |          |               |               |               |               |       |
| M 10x1,50 | 8,50  | R 100 x 22 x 10,0 x 8,0  | 35,83    | 40,77    | 26,15    | 29,18    | 35,83    | 40,77         | 37,01         | 45,33         | 42,48         | 48,26 |
|           |       | M2D4H                    | M4D4H    | M2D6G    | M4D6G    | M2D7G    | M4D7G    | M2D+0,1       | M4D+0,1       | M2D+0,2       | M4D+0,2       |       |
| M 12x1,50 | 10,50 | D 100 x 22 x 9,0 x 7,0   |          | 76,60    | 90,81    |          |          |               |               |               |               |       |
| M 12x1,75 | 10,20 | D 110 x 24 x 9,0 x 7,0   | 46,20    | 54,85    | 34,48    | 41,54    | 46,20    | 54,85         | 46,35         | 58,76         | 52,66         | 62,57 |
| M 14x2,00 | 12,00 | D 110 x 26 x 11,0 x 9,0  |          | 42,36    | 50,89    |          |          | 75,61         | 93,53         | 85,92         | 99,61         |       |
| M 16x2,00 | 14,00 | D 110 x 27 x 12,0 x 9,0  |          | 52,35    | 61,47    |          |          | 88,92         | 113,03        | 101,08        | 120,37        |       |
| M 18x2,50 | 15,50 | D 125 x 30 x 14,0 x 11,0 |          | 73,83    | 76,10    |          |          | 134,46        | 152,24        | 143,18        | 162,11        |       |
| M 20x2,50 | 17,50 | D 140 x 32 x 16,0 x 12,0 |          | 76,25    | 87,48    |          |          | 145,29        | 161,99        | 154,71        | 172,50        |       |

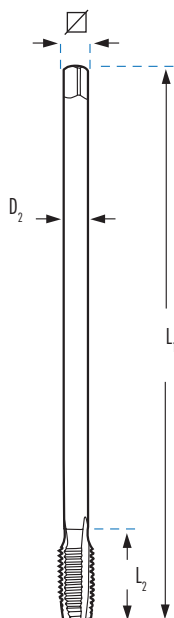

4H.- Highly accurate threads. Finer adjustment.  
 6G.- For coating threads. Thicknesses between 20 - 40 μ  
 7G.- For coating threads. Thicknesses between 40 - 50 μ  
 6H (+0,1).- To make oversized threads or compensate heat treatment deformations.  
 6H (+0,2).- To make oversized threads or compensate heat treatment deformations.

**HSSCo EXTRA-LONG MACHINE TAPS**
**B  
FORM**

**HSSCo  
5%**
**BRIGHT**
**TOL  
6H**
**R  
REINFORCED  
SHANK**
**DIN  
371**
**D  
REDUCED  
SHANK**
**DIN  
376**

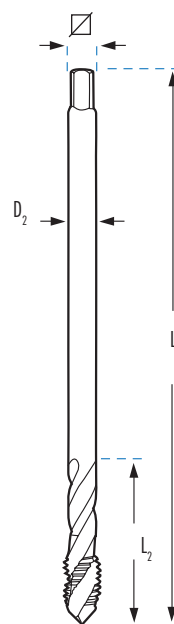
|                      |  |   |   |  | M2L          |
|----------------------|--|---|---|--|--------------|
|                      |  |  |   | L1 x L2 x D2 x  | B FORM       |
|                      |  |   |   | mm   | €            |
| M2LM03X0,50          | M 3x0,50   | 2,50  | R | 100 x 10 x 3,5 x 2,7   | 38,63        |
| M2LM04X0,70          | M 4x0,70   | 3,30  | R | 120 x 12 x 4,5 x 3,4   | 39,48        |
| M2LM05X0,80          | M 5x0,80   | 4,20  | R | 140 x 14 x 6,0 x 4,9   | 39,48        |
| M2LM06X1,00-120      | M 6x1,00   | 5,00  | R | 120 x 16 x 6,0 x 4,9   | 41,67        |
| M2LM06X1,00          | M 6x1,00   | 5,00  | R | 160 x 16 x 6,0 x 4,9   | 43,38        |
| M2LM07X1,00          | M 7x1,00   | 6,00  | R | 160 x 17 x 7,0 x 5,5   | 49,27        |
| M2LM08X1,25-150      | M 8x1,25   | 6,80  | R | 150 x 18 x 8,0 x 6,2   | 49,34        |
| M2LM08X1,25          | M 8x1,25   | 6,80  | R | 180 x 18 x 8,0 x 6,2   | 50,86        |
| <b>REDUCED SHANK</b> |  |   |   |  | <b>M2L-D</b> |
| M2LM06X1,00D         | M 6x1,00   | 5,00  | D | 160 x 16 x 4,5 x 3,4   | 45,03        |
| M2LM08X1,25D         | M 8x1,25   | 6,80  | D | 180 x 18 x 6,2 x 5,0   | 52,84        |
| M2LM10X1,50-150      | M 10x1,50  | 8,50  | D | 150 x 20 x 7,0 x 5,5   | 58,13        |
| M2LM10X1,50          | M 10x1,50  | 8,50  | D | 200 x 20 x 7,0 x 5,5   | 62,61        |
| M2LM12X1,75-150      | M 12x1,75  | 10,20   | D | 150 x 22 x 8,5 x 6,5   | 72,11        |
| M2LM12X1,75          | M 12x1,75  | 10,20   | D | 220 x 22 x 8,5 x 6,5   | 77,04        |
| M2LM14X2,00          | M 14x2,00  | 12,00   | D | 220 x 25 x 10,5 x 8,0  | 119,55       |
| M2LM16X2,00          | M 16x2,00  | 14,00   | D | 220 x 28 x 12,5 x 10,0   | 140,64       |
| M2LM18X2,50          | M 18x2,50  | 15,50   | D | 250 x 32 x 14,0 x 11,0   | 255,90       |
| M2LM20X2,50          | M 20x2,50  | 17,50   | D | 250 x 32 x 16,0 x 12,0   | 276,57       |
| M2LM22X2,50          | M 22x2,50  | 19,50   | D | 250 x 35 x 18,0 x 14,5   | 315,32       |
| M2LM24X3,00          | M 24x3,00  | 21,00   | D | 250 x 38 x 18,0 x 14,5   | 385,57       |

**HSSCo  
5%**
**BRIGHT**
**TOL  
6H**
**R  
REINFORCED  
SHANK**
**DIN  
371**
**D  
REDUCED  
SHANK**
**DIN  
376**

|                      |  |   |   |  | M4L          |
|----------------------|--|---|---|--|--------------|
|                      |  |  |   | L1 x L2 x D2 x  | 35°          |
|                      |  |   |   | mm   | €            |
| M4LM03X0,50          | M 3x0,50   | 2,50  | R | 100 x 10 x 3,5 x 2,7   | 47,80        |
| M4LM04X0,70          | M 4x0,70   | 3,30  | R | 120 x 12 x 4,5 x 3,4   | 47,80        |
| M4LM05X0,80          | M 5x0,80   | 4,20  | R | 140 x 14 x 6,0 x 4,9   | 45,79        |
| M4LM06X1,00-120      | M 6x1,00   | 5,00  | R | 120 x 16 x 6,0 x 4,9   | 47,21        |
| M4LM06X1,00          | M 6x1,00   | 5,00  | R | 160 x 16 x 6,0 x 4,9   | 50,23        |
| M4LM07X1,00          | M 7x1,00   | 6,00  | R | 160 x 17 x 7,0 x 5,5   | 57,03        |
| M4LM08X1,25-150      | M 8x1,25   | 6,80  | R | 150 x 18 x 8,0 x 6,2   | 57,86        |
| M4LM08X1,25          | M 8x1,25   | 6,80  | R | 180 x 18 x 8,0 x 6,2   | 61,04        |
| <b>REDUCED SHANK</b> |  |   |   |  | <b>M4L-D</b> |
| M4LM06X1,00D         | M 6x1,00   | 5,00  | D | 160 x 16 x 4,5 x 3,4   | 52,19        |
| M4LM08X1,25D         | M 8x1,25   | 6,80  | D | 180 x 18 x 6,2 x 5,0   | 62,15        |
| M4LM10X1,50-150      | M 10x1,50  | 8,50  | D | 150 x 20 x 7,0 x 5,5   | 65,48        |
| M4LM10X1,50          | M 10x1,50  | 8,50  | D | 200 x 20 x 7,0 x 5,5   | 70,74        |
| M4LM12X1,75-150      | M 12x1,75  | 10,20   | D | 150 x 22 x 8,5 x 6,5   | 80,18        |
| M4LM12X1,75          | M 12x1,75  | 10,20   | D | 220 x 22 x 8,5 x 6,5   | 91,51        |
| M4LM14X2,00          | M 14x2,00  | 12,00   | D | 220 x 25 x 10,5 x 8,0  | 133,96       |
| M4LM16X2,00          | M 16x2,00  | 14,00   | D | 220 x 28 x 12,5 x 10,0   | 194,13       |
| M4LM18X2,50          | M 18x2,50  | 15,50   | D | 250 x 32 x 14,0 x 11,0   | 289,75       |
| M4LM20X2,50          | M 20x2,50  | 17,50   | D | 250 x 32 x 16,0 x 12,0   | 308,37       |
| M4LM22X2,50          | M 22x2,50  | 19,50   | D | 250 x 35 x 18,0 x 14,5   | 345,44       |
| M4LM24X3,00          | M 24x3,00  | 21,00   | D | 250 x 38 x 18,0 x 14,5   | 393,79       |

**EXTRA-LONG NUT MACHINE TAPS**



**HSSCo**  
5%

**BRIGHT**

**TOL**  
6H

**DIN**  
357

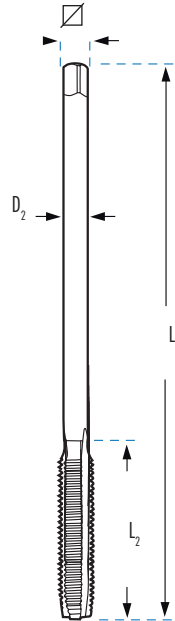

|   |          |                                | MTU       |         |
|---|----------|--------------------------------|-----------|---------|
|   |          | L1 x L2 x D2 x $\square$<br>mm | A<br>FORM | €       |
| M | 3x0,50** | 2,50 D 70 x 22 x 2,2           |           | 25,34   |
| M | 4x0,70   | 3,30 D 90 x 25 x 2,8 x 2,1     |           | 25,34   |
| M | 5x0,80   | 4,20 D 100 x 28 x 3,5 x 2,7    |           | 25,34   |
| M | 6x1,00   | 5,00 D 110 x 32 x 4,5 x 3,4    |           | 25,34   |
| M | 8x1,25   | 6,80 D 125 x 40 x 6,0 x 4,9    |           | 30,54   |
| M | 10x1,50  | 8,50 D 140 x 45 x 7,0 x 5,5    |           | 29,85   |
| M | 12x1,75  | 10,20 D 180 x 50 x 9,0 x 7,0   |           | 36,15   |
| M | 14x2,00  | 12,00 D 200 x 56 x 11,0 x 9,0  |           | 57,13   |
| M | 16x2,00  | 14,00 D 200 x 63 x 12,0 x 9,0  |           | 70,73   |
| M | 18x2,50  | 15,50 D 220 x 63 x 14,0 x 11,0 |           | 95,15   |
| M | 20x2,50  | 17,50 D 250 x 70 x 16,0 x 12,0 |           | 134,33* |
| M | 22x2,50  | 19,50 D 280 x 80 x 18,0 x 14,5 |           | 164,81* |
| M | 24x3,00  | 21,00 D 280 x 80 x 18,0 x 14,5 |           | 224,25* |

\*\*Cylindrical shank

\*Available until end of stock

**HSS MACHINE TAPS FOR TRAPEZOIDAL THREADS**

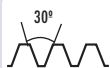

**HSS**

**BRIGHT**



**DIN**  
103

**TOL**  
7H

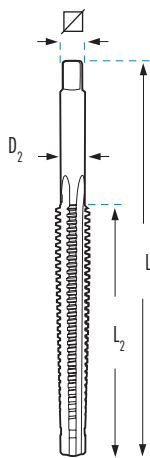

|    |        |                                | MRTM     |  |
|----|--------|--------------------------------|----------|--|
|    |        | L1 x L2 x D2 x $\square$<br>mm | €        |  |
| Tr | 14 x 3 | 11,25 160 x 105 x 10,5 x 8,0   | 598,95   |  |
| Tr | 16 x 4 | 12,25 205 x 110 x 11,5 x 9,0   | 623,53   |  |
| Tr | 18 x 4 | 14,25 215 x 120 x 13,0 x 10,0  | 657,30   |  |
| Tr | 20 x 4 | 16,25 230 x 130 x 15,0 x 12,0  | 660,38   |  |
| Tr | 22 x 5 | 17,25 270 x 165 x 16,0 x 12,0  | 869,25   |  |
| Tr | 24 x 5 | 19,25 280 x 165 x 18,0 x 14,5  | 985,98   |  |
| Tr | 26 x 5 | 21,25 290 x 170 x 20,0 x 16,0  | 1.020,18 |  |
| Tr | 28 x 5 | 23,25 300 x 180 x 22,0 x 18,0  | 1.155,64 |  |
| Tr | 30 x 6 | 24,25 345 x 200 x 23,0 x 18,0  | 1.329,98 |  |

**HSSCo DRILL-TAPS**

Threading tools

Pink



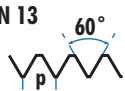

DIN 13

**HSSCo**  
**5%**

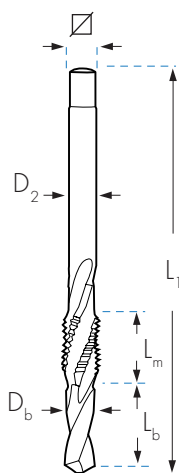
BRIGHT

**TOL**  
**6H**
**R**  
**REINFORCED**  
**SHANK**
**DIN**  
**371**
**D**  
**REDUCED**  
**SHANK**
**DIN**  
**376**

|   |   |          |          |          |          |          |         | M8M |       |
|---|---|----------|----------|----------|----------|----------|---------|-----|-------|
|  |  | Lb<br>mm | Lm<br>mm | L1<br>mm | Db<br>mm | D2<br>mm | ∅<br>mm | €   |       |
| M   | 3x0,50  | R        | 9,0      | 12,5     | 62,0     | 2,5      | 3,5     | 2,7 | 38,84 |
| M   | 4x0,70  | R        | 10,0     | 16,0     | 66,0     | 3,30     | 4,5     | 3,4 | 38,84 |
| M   | 5x0,80  | R        | 12,5     | 18,0     | 75,5     | 4,20     | 6,0     | 4,9 | 40,36 |
| M   | 6x1,00  | R        | 14,0     | 20,0     | 81,0     | 5,00     | 6,0     | 4,9 | 44,57 |
| M   | 8x1,00  | R        | 20,0     | 14,0     | 91,0     | 7,00     | 6,0     | 4,9 | 52,32 |
| M   | 8x1,25  | R        | 20,0     | 14,0     | 91,0     | 6,75     | 8,0     | 6,2 | 50,25 |

**REDUCED SHANK**

|   |         |   |      |      |       |       |      |      |        |
|---|---------|---|------|------|-------|-------|------|------|--------|
| M | 8x1,25  | D | 20,0 | 14,0 | 91,0  | 6,75  | 6,0  | 4,9  | 54,29  |
| M | 10x1,00 | D | 20,0 | 15,0 | 95,0  | 9,00  | 7,0  | 5,5  | 64,94  |
| M | 10x1,50 | D | 25,0 | 18,0 | 105,0 | 8,50  | 7,0  | 5,5  | 68,93  |
| M | 12x1,50 | D | 24,0 | 18,0 | 110,0 | 10,50 | 9,0  | 7,0  | 75,23  |
| M | 12x1,75 | D | 28,0 | 20,0 | 118,0 | 12,50 | 11,0 | 9,0  | 74,79  |
| M | 14x1,50 | D | 28,0 | 20,0 | 118,0 | 12,50 | 11,0 | 9,0  | 119,05 |
| M | 14x2,00 | D | 28,0 | 22,0 | 130,0 | 12,00 | 11,0 | 9,0  | 135,41 |
| M | 16x2,00 | D | 36,0 | 24,0 | 139,0 | 14,00 | 12,0 | 9,0  | 178,09 |
| M | 18x2,50 | D | 40,0 | 26,0 | 151,0 | 15,50 | 14,0 | 11,0 | 259,75 |
| M | 20x2,50 | D | 45,0 | 30,0 | 168,0 | 17,50 | 16,0 | 2,0  | 373,02 |

Note: Never use the drill taps in blind hole or through hole deeper than Lb

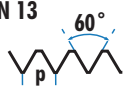

**HSSCO STEP CUT DRILL-TAP WITH COUNTERSINK**
**NEW**

DIN 13

**HSSCo**  
**5%**

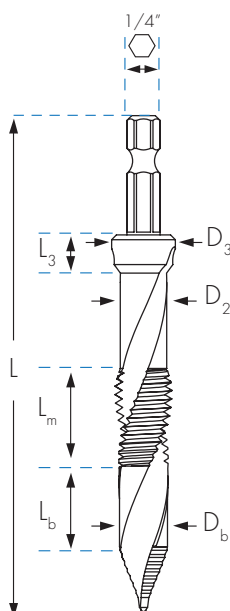
BRIGHT

**TOL**  
**6H**
**D**  
**REDUCED**  
**SHANK**
**1/4"**
**STEP CUT**

|   |   |          |          |          |         |          |          |          |         | MTKM |       |
|---|---|----------|----------|----------|---------|----------|----------|----------|---------|------|-------|
|  |  | Lb<br>mm | Lm<br>mm | L3<br>mm | L<br>mm | Db<br>mm | D2<br>mm | D3<br>mm | ∅<br>mm | €    |       |
| M   | 3x0,50  | D        | 7,0      | 6,0      | 6,0     | 57,0     | 2,5      | 2,2      | 7,3     | 1/4" | 28,21 |
| M   | 4x0,70  | D        | 7,0      | 8,5      | 6,0     | 62,0     | 3,3      | 3,0      | 7,3     | 1/4" | 28,21 |
| M   | 5x0,80  | D        | 9,0      | 10,0     | 6,0     | 69,0     | 4,2      | 3,7      | 7,3     | 1/4" | 29,44 |
| M   | 6x1,00  | D        | 10,0     | 12,0     | 6,0     | 73,0     | 5,0      | 4,5      | 7,3     | 1/4" | 30,66 |
| M   | 8x1,25  | D        | 12,0     | 16,0     | 6,0     | 87,0     | 6,8      | 6,3      | 9,4     | 1/4" | 42,38 |
| M   | 10x1,50   | D        | 14,0     | 20,0     | 6,0     | 96,0     | 8,5      | 8,0      | 11,4    | 1/4" | 51,14 |
| M   | 12x1,75   | D        | 16,0     | 24,0     | 8,0     | 112,0    | 10,3     | 9,8      | 13,4    | 1/4" | 56,36 |

Note: Never use the drill taps countersink in blind hole or through hole deeper than Lb

**INDEXABLE THREAD TURNING INSERT**

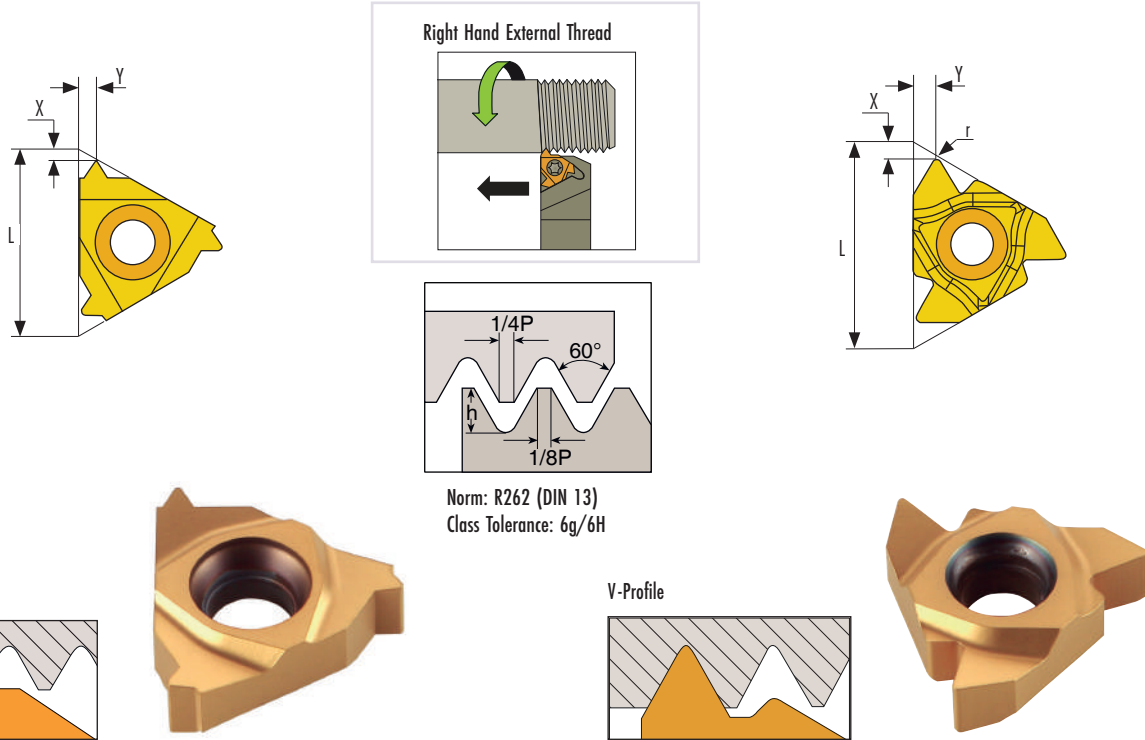

Norm: R262 (DIN 13)  
Class Tolerance: 6g/6H

Full Profile

V-Profile

Form a complete thread, including the crest.  
We'll need a separate insert for each pitch and profile

Doesn't top the thread crests.  
The same insert may be used for a range of pitches with the same thread profile angle

**FULL PROFILE 60°**

| EXTERNAL THREADING | L  | Pitch | h    | X   | Y   | €      |
|--------------------|----|-------|------|-----|-----|--------|
| PRE-16-075         | 16 | 0,75  | 0,46 | 0,6 | 0,6 | 26,84* |
| PRE-16-100         |    | 1,00  | 0,61 | 0,7 | 0,7 | 26,84* |
| PRE-16-125         |    | 1,25  | 0,77 | 0,8 | 0,9 | 26,84* |
| PRE-16-150         |    | 1,50  | 0,92 | 0,8 | 1   | 26,84* |
| PRE-16-175         |    | 1,75  | 1,07 | 0,9 | 1,2 | 26,84* |
| PRE-16-200         |    | 2,00  | 1,23 | 1   | 1,3 | 26,84* |
| PRE-16-250         |    | 2,50  | 1,53 | 1,1 | 1,5 | 26,84* |
| PRE-16-300         |    | 3,00  | 1,84 | 1,2 | 1,6 | 26,84* |

\* Till end of stock

**V-PROFILE 60°**

| EXTERNAL THREADING | L  | METRIC RANGE | INCH RANGE | r    | X    | Y    | €      |
|--------------------|----|--------------|------------|------|------|------|--------|
| PPRE-16-150        | 16 | 0,50-1,50    | 48 - 16    | 0,05 | 0,80 | 0,90 | 26,84* |

\* Till end of stock

**TOOL HOLDER FOR EXTERNAL THREADING**

| EXTERNAL THREADING | H1=H=B=F | L1  | L2 | €       |
|--------------------|----------|-----|----|---------|
| PEXT-25-16         | 25       | 153 | 30 | 196,21* |

\* Till end of stock

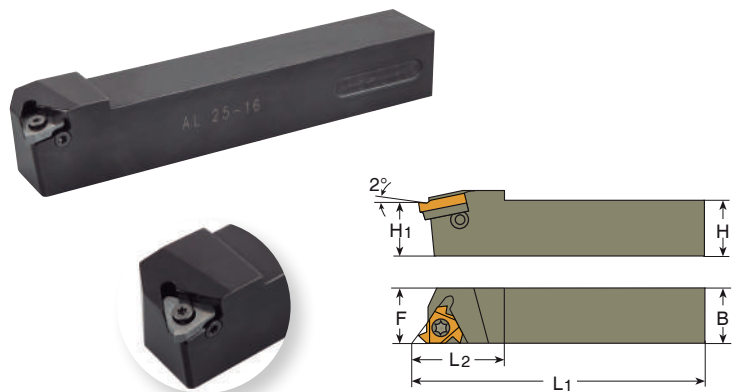

**FORMULA TO CALCULATE THE TURNING SPEED OF THE WORKPIECE**

**N:** Revolution per Minute  
**Vc:** Cutting Speed (m/min)  
**D:** Workpiece Diameter (mm)

$$RPM = \frac{1000 \times Vc}{\pi \times D}$$

RPM Depends on Vc and D

|  |                     |           |                     |
|--|---------------------|-----------|---------------------|
| STEEL<br>70 kg/mm <sup>2</sup>           | Cs<br>25<br>m / min | ALUMINIUM | Cs<br>50<br>m / min |
| HARDENED STEEL<br>120 kg/mm <sup>2</sup> | 13<br>m / min       | TITANIUM  | 18<br>m / min       |
| STAINLESS STEEL                          | 11<br>m / min       | CAST IRON | 25<br>m / min       |
|  |                     | BRASS     | 50<br>m / min       |

INDEXABLE THREAD TURNING INSERT

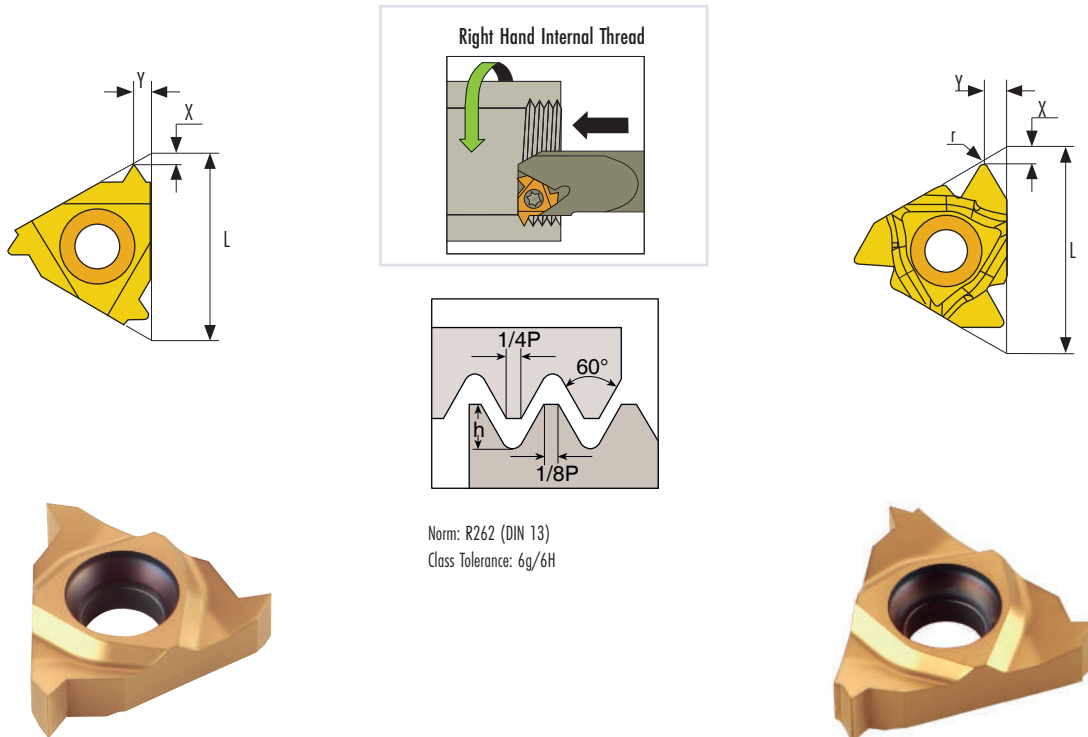

Norm: R262 (DIN 13)  
Class Tolerance: 6g/6H

FULL PROFILE 60°

| INTERNAL THREADING | L  | Pitch | h    | X   | Y   | €       |
|--------------------|----|-------|------|-----|-----|---------|
| PRI-16-075         | 16 | 0,75  | 0,43 | 0,6 | 0,6 | 26,84 * |
| PRI-16-100         |    | 1,00  | 0,58 | 0,6 | 0,7 | 26,84 * |
| PRI-16-125         |    | 1,25  | 0,72 | 0,8 | 0,9 | 26,84 * |
| PRI-16-150         |    | 1,50  | 0,87 | 0,8 | 1,0 | 26,84 * |
| PRI-16-175         |    | 1,75  | 1,01 | 0,9 | 1,2 | 26,84 * |
| PRI-16-200         |    | 2,00  | 1,15 | 1,0 | 1,3 | 26,84 * |
| PRI-16-250         |    | 2,50  | 1,44 | 1,1 | 1,5 | 26,84 * |
| PRI-16-300         |    | 3,00  | 1,73 | 1,1 | 1,5 | 26,84 * |

\* Till end of stock

V-PROFILE 60°

| INTERNAL THREADING | L  | METRIC RANGE | INCH RANGE | r    | X    | Y    | €       |
|--------------------|----|--------------|------------|------|------|------|---------|
| PPRI-16-150        | 16 | 0,50-1,50    | 48 - 16    | 0,05 | 0,80 | 0,90 | 26,84 * |
| PPRI-16-300        |    | 1,75-3,00    | 14 - 8     | 0,16 | 1,20 | 1,70 | 26,84 * |

\* Till end of stock

TOOL HOLDER FOR INTERNAL THREADING

| INTERNAL THREADING | L   | L1 | D  | D1   | A    | Ø MÍN. HOLE | €        |
|--------------------|-----|----|----|------|------|-------------|----------|
| PINT-25-16         | 200 | 45 | 25 | 24,6 | 22,6 | 29          | 236,46 * |

\* Till end of stock

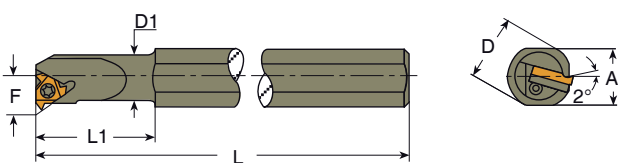

**MACHINE TAPS FOR GENERAL PURPOSE IN METAL BOXES**

**GENERAL  
PURPOSE**

**HSSCo  
5%**

Threading tools

Pink



Ref. JM6



Ref. JM2





Ref. JM8



Ref. JM4

**CONTENT**

|     | <b>C<br/>FORM</b>                   | <b>B<br/>FORM</b>                   |  <b>15°</b> |  <b>35°</b> |  <b>HSS</b> | <b>HSSCo 5%</b><br>€ |
|-----|-------------------------------------|-------------------------------------|---|---|---|----------------------|
| JM5 | M3 - M4 - M5 - M6<br>M8 - M10 - M12 | -                                   | -   | -   | -   | <b>111,81</b>        |
| JM1 | M3 - M4 - M5 - M6<br>M8 - M10 - M12 | -                                   | -   | -   | 2.5/3.3/4.2/5.0/6.8/8.5/10.2 mm   | <b>133,74</b>        |
| JM6 | -                                   | M3 - M4 - M5 - M6<br>M8 - M10 - M12 | -   | -   | -   | <b>119,13</b>        |
| JM2 | -                                   | M3 - M4 - M5 - M6<br>M8 - M10 - M12 | -   | -   | 2.5/3.3/4.2/5.0/6.8/8.5/10.2 mm   | <b>133,98</b>        |
| JM7 | -                                   | -                                   | M3 - M4 - M5 - M6<br>M8 - M10 - M12   | -   | -   | <b>148,42</b>        |
| JM3 | -                                   | -                                   | M3 - M4 - M5 - M6<br>M8 - M10 - M12   | -   | 2.5/3.3/4.2/5.0/6.8/8.5/10.2 mm   | <b>177,35</b>        |
| JM8 | -                                   | -                                   | -   | M3 - M4 - M5 - M6<br>M8 - M10 - M12   | -   | <b>150,98</b>        |
| JM4 | -                                   | -                                   | -   | M3 - M4 - M5 - M6<br>M8 - M10 - M12   | 2.5/3.3/4.2/5.0/6.8/8.5/10.2 mm   | <b>175,46</b>        |

## MACHINE TAPS FOR SPECIAL APPLICATIONS IN METAL BOXES

Plus



Ref. JMPT2

## CONTENT

|      | B<br>FORM                           | BRIGHT | 35°<br>BRIGHT                       | HSSCo<br>5%                     | HSS PM<br>€ |       | TiN<br>€ |
|------|-------------------------------------|--------|-------------------------------------|---------------------------------|-------------|-------|----------|
| JMP6 | M3 - M4 - M5 - M6<br>M8 - M10 - M12 |        | -                                   | -                               | 124,14      | JMPT6 | 179,05   |
| JMP2 | M3 - M4 - M5 - M6<br>M8 - M10 - M12 |        | -                                   | 2.5/3.3/4.2/5.0/6.8/8.5/10.2 mm | 162,80      | JMPT2 | 217,85   |
| JMP8 | -                                   |        | M3 - M4 - M5 - M6<br>M8 - M10 - M12 | -                               | 179,05      | JMPT8 | 197,20   |
| JMP4 | -                                   |        | M3 - M4 - M5 - M6<br>M8 - M10 - M12 | 2.5/3.3/4.2/5.0/6.8/8.5/10.2 mm | 217,85      | JMPT4 | 236,13   |

INOX

## CONTENT

|      | B<br>FORM                           | OX | 35°<br>OX                           | HSSCo<br>5%                     | HSS PM<br>€ |       | TiN<br>€ |
|------|-------------------------------------|----|-------------------------------------|---------------------------------|-------------|-------|----------|
| JMX6 | M3 - M4 - M5 - M6<br>M8 - M10 - M12 |    | -                                   | -                               | 160,16      | JMXT6 | 174,71   |
| JMX2 | M3 - M4 - M5 - M6<br>M8 - M10 - M12 |    | -                                   | 2.5/3.3/4.2/5.0/6.8/8.5/10.2 mm | 198,98      | JMXT2 | 213,53   |
| JMX8 | -                                   |    | M3 - M4 - M5 - M6<br>M8 - M10 - M12 | -                               | 182,77      | JMXT8 | 201,50   |
| JMX4 | -                                   |    | M3 - M4 - M5 - M6<br>M8 - M10 - M12 | 2.5/3.3/4.2/5.0/6.8/8.5/10.2 mm | 221,57      | JMXT4 | 240,29   |

 1200  
N/mm<sup>2</sup>

## CONTENT

|       | B<br>FORM                           | OX | 35°<br>OX                           | HSSCo<br>5%                     | HSS V3<br>€ |        | TINALOX<br>€ |
|-------|-------------------------------------|----|-------------------------------------|---------------------------------|-------------|--------|--------------|
| JMMD6 | M3 - M4 - M5 - M6<br>M8 - M10 - M12 |    | -                                   | -                               | 145,58      | JMMDT6 | 206,68       |
| JMMD2 | M3 - M4 - M5 - M6<br>M8 - M10 - M12 |    | -                                   | 2.5/3.3/4.2/5.0/6.8/8.5/10.2 mm | 184,39      | JMMDT2 | 245,48       |
| JMMD8 | -                                   |    | M3 - M4 - M5 - M6<br>M8 - M10 - M12 | -                               | 166,15      | JMMDT8 | 238,33       |
| JMMD4 | -                                   |    | M3 - M4 - M5 - M6<br>M8 - M10 - M12 | 2.5/3.3/4.2/5.0/6.8/8.5/10.2 mm | 204,95      | JMMDT4 | 277,13       |

**MACHINE TAPS FOR SPECIAL APPLICATIONS IN METAL BOXES**

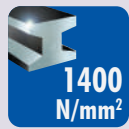

Ref. JMC2

**CONTENT**

|      | B<br>FORM                          | TiCN | 15°<br>TiCN                        | HSSCo<br>5%                     | HSS-PM<br>€ |
|------|------------------------------------|------|------------------------------------|---------------------------------|-------------|
| JMC6 | M3 - M4 - M5 - M6 - M8 - M10 - M12 |      | -                                  | -                               | 247,65      |
| JMC2 | M3 - M4 - M5 - M6 - M8 - M10 - M12 |      | -                                  | 2.5/3.3/4.2/5.0/6.8/8.5/10.2 mm | 286,46      |
| JMC8 | -                                  |      | M3 - M4 - M5 - M6 - M8 - M10 - M12 | -                               | 281,89      |
| JMC4 | -                                  |      | M3 - M4 - M5 - M6 - M8 - M10 - M12 | 2.5/3.3/4.2/5.0/6.8/8.5/10.2 mm | 320,70      |

**ALL  
ROAD**

**CONTENT**

|      | B<br>FORM                          | TiN | 35°<br>TiN                         | HSSCo<br>5%                     | HSSCo 5%<br>€ |
|------|------------------------------------|-----|------------------------------------|---------------------------------|---------------|
| JMD6 | M3 - M4 - M5 - M6 - M8 - M10 - M12 |     | -                                  | -                               | 223,80        |
| JMD2 | M3 - M4 - M5 - M6 - M8 - M10 - M12 |     | -                                  | 2.5/3.3/4.2/5.0/6.8/8.5/10.2 mm | 262,61        |
| JMD8 | -                                  |     | M3 - M4 - M5 - M6 - M8 - M10 - M12 | -                               | 252,38        |
| JMD4 | -                                  |     | M3 - M4 - M5 - M6 - M8 - M10 - M12 | 2.5/3.3/4.2/5.0/6.8/8.5/10.2 mm | 291,19        |

**AI**

**CONTENT**

|       | INTERRUPTED<br>THREAD              | BRIGHT | 2<br>FLUTES                        | BRIGHT | HSS                             | HSSCo 5%<br>€ |
|-------|------------------------------------|--------|------------------------------------|--------|---------------------------------|---------------|
| JMAL6 | M3 - M4 - M5 - M6 - M8 - M10 - M12 |        | -                                  |        | -                               | 177,20        |
| JMAL2 | M3 - M4 - M5 - M6 - M8 - M10 - M12 |        | -                                  |        | 2.5/3.3/4.2/5.0/6.8/8.5/10.2 mm | 216,00        |
| JMAL8 | -                                  |        | M3 - M4 - M5 - M6 - M8 - M10 - M12 |        | -                               | 175,22        |
| JMAL4 | -                                  |        | M3 - M4 - M5 - M6 - M8 - M10 - M12 |        | 2.5/3.3/4.2/5.0/6.8/8.5/10.2 mm | 214,03        |

## MACHINE TAPS IN PLASTIC BOXES

GENERAL  
PURPOSE

## CONTENT

|      | B<br>FORM               | BRIGHT                  | 35°                     | BRIGHT                  | HSSCo 5% | €      |
|------|-------------------------|-------------------------|-------------------------|-------------------------|----------|--------|
| PT01 | M4 - M5 - M6 - M8 - M10 | M4 - M5 - M6 - M8 - M10 | M4 - M5 - M6 - M8 - M10 | M4 - M5 - M6 - M8 - M10 |          | 135,91 |



Ref. PT01

## Plus

## CONTENT

|      | B<br>FORM               | BRIGHT                  | 35°                     | BRIGHT                  | HSS PM |      | TiN    |
|------|-------------------------|-------------------------|-------------------------|-------------------------|--------|------|--------|
| PT02 | M4 - M5 - M6 - M8 - M10 | M4 - M5 - M6 - M8 - M10 | M4 - M5 - M6 - M8 - M10 | M4 - M5 - M6 - M8 - M10 | €      | PT03 | €      |
|      |                         |                         |                         |                         | 170,97 |      | 251,09 |



Ref. PT03

## INOX

## CONTENT

|      | B<br>FORM               | OX                      | 35°                     | OX                      | HSS PM |      | TiN    |
|------|-------------------------|-------------------------|-------------------------|-------------------------|--------|------|--------|
| PT05 | M4 - M5 - M6 - M8 - M10 | M4 - M5 - M6 - M8 - M10 | M4 - M5 - M6 - M8 - M10 | M4 - M5 - M6 - M8 - M10 | €      | PT13 | €      |
|      |                         |                         |                         |                         | 224,65 |      | 239,07 |



Ref. PT05



## CONTENT

|      | B<br>FORM               | OX                      | 35°                     | OX                      | HSS V3 |      | TINALOX |
|------|-------------------------|-------------------------|-------------------------|-------------------------|--------|------|---------|
| PT04 | M4 - M5 - M6 - M8 - M10 | M4 - M5 - M6 - M8 - M10 | M4 - M5 - M6 - M8 - M10 | M4 - M5 - M6 - M8 - M10 | €      | PT14 | €       |
|      |                         |                         |                         |                         | 192,79 |      | 289,73  |



Ref. PT04



## CONTENT

|      | B<br>FORM               | TiCN                    | 15°                     | TiCN                    | HSS PM | €      |
|------|-------------------------|-------------------------|-------------------------|-------------------------|--------|--------|
| PT11 | M4 - M5 - M6 - M8 - M10 | M4 - M5 - M6 - M8 - M10 | M4 - M5 - M6 - M8 - M10 | M4 - M5 - M6 - M8 - M10 |        | 349,27 |



Ref. PT11

**MACHINE TAPS IN PLASTIC BOXES**

Threading tools

Pink

**Al**



Ref. PT06

**CONTENT**

|      | INTERRUPTED<br>THREAD    | 2<br>FLUTES              | HSSCo 5%<br>€ |
|------|--------------------------|--------------------------|---------------|
| PT06 | M4 - M5 - M6<br>M8 - M10 | M4 - M5 - M6<br>M8 - M10 | 213,14        |

**CAST  
IRON**



Ref. PT07

**CONTENT**

|      | C<br>FORM  | HSSCo 5%<br>€ |
|------|--|---------------|
| PT07 | M4 - M5 - M6 - M8 - M10<br>M4 - M5 - M6 - M8 - M10 | 161,08        |

**BRASS**



Ref. PT10

**CONTENT**

|      | C<br>FORM  | HSSCo 5%<br>€ |
|------|--|---------------|
| PT10 | M4 - M5 - M6 - M8 - M10<br>M4 - M5 - M6 - M8 - M10 | 195,81        |

**FORMING**



Ref. PT08

**CONTENT**

|      |  | HSSCo 5%<br>€ |
|------|---|---------------|
| PT08 | M4 - M5 - M6 - M8 - M10<br>M4 - M5 - M6 - M8 - M10                                    | 294,81        |





Ref. PT09

**CONTENT**

|      |  | HSSCo 5%<br>€ |
|------|--|---------------|
| PT09 | M4 - M5 - M6 - M8 - M10<br>M4 - M5 - M6 - M8 - M10 | 397,16        |

**TOL  
6G**



Ref. PT12

**CONTENT**

|      | B<br>FORM                |  35° | HSSCo 5%<br>€ |
|------|--------------------------|---|---------------|
| PT12 | M4 - M5 - M6<br>M8 - M10 | M4 - M5 - M6<br>M8 - M10  | 220,24        |

## MACHINE TAPS METHACRYLATE DISPLAYS

## METHACRYLATE DISPLAY

MM-03

Content: Standard series machine taps

HSSCo  
5%

Ref. MM-03

| B<br>FORM | B Form through holes: Ref. M2 |    |    |    |     |     |     |
|-----------|-------------------------------|----|----|----|-----|-----|-----|
|           | M4                            | M5 | M6 | M8 | M10 | M12 | M14 |
|           | 5                             | 10 | 10 | 10 | 10  | 5   | 4   |

| 35° | 35° blind holes: Ref. M4 |    |    |    |     |     |     |
|-----|--------------------------|----|----|----|-----|-----|-----|
|     | M4                       | M5 | M6 | M8 | M10 | M12 | M14 |
|     | 5                        | 10 | 10 | 10 | 10  | 5   | 4   |

Dimensions: width 240 x depth 240 x height 245 mm.

2.091,99 €



Ref. MM-04

## METHACRYLATE DISPLAY

MM-04

Content: Plus series machine taps  
Manufactured in powder steel (ASP)HSS  
PM

Plus

| B<br>FORM | B Form through holes: Ref. M2 |    |    |    |     |     |     |
|-----------|-------------------------------|----|----|----|-----|-----|-----|
|           | M4                            | M5 | M6 | M8 | M10 | M12 | M14 |
|           | 5                             | 10 | 10 | 10 | 10  | 5   | 4   |

| 35° | 35° blind holes: Ref. M4 |    |    |    |     |     |     |
|-----|--------------------------|----|----|----|-----|-----|-----|
|     | M4                       | M5 | M6 | M8 | M10 | M12 | M14 |
|     | 5                        | 10 | 10 | 10 | 10  | 5   | 4   |

Dimensions: width 240 x depth 240 x height 245 mm.

2.854,15 €

## METHACRYLATE DISPLAY

MM-05

Content: Machine taps for special works

| B<br>FORM                 | B Form through holes: Ref. M2 |    |    |    |     |     |     |
|---------------------------|-------------------------------|----|----|----|-----|-----|-----|
|                           | M4                            | M5 | M6 | M8 | M10 | M12 | M14 |
| 1200<br>N/mm <sup>2</sup> | 1                             | 2  | 2  | 2  | 2   | 1   | 1   |
| INOX                      | 1                             | 2  | 2  | 2  | 2   | 1   | 1   |
| Al                        | 1                             | 2  | 2  | 2  | 2   | 1   | 1   |
| TiN                       | 1                             | 2  | 2  | 2  | 2   | 1   | 1   |
| 1400<br>N/mm <sup>2</sup> | 1                             | 2  | 2  | 2  | 2   | 1   |     |

 35° blind holes: Ref. M4

| 35°                       | 35° blind holes: Ref. M4 |    |    |    |     |     |     |
|---------------------------|--------------------------|----|----|----|-----|-----|-----|
|                           | M4                       | M5 | M6 | M8 | M10 | M12 | M14 |
| 1200<br>N/mm <sup>2</sup> | 1                        | 2  | 2  | 2  | 2   | 1   | 1   |
| INOX                      | 1                        | 2  | 2  | 2  | 2   | 1   | 1   |
| Al                        | 1                        | 2  | 2  | 2  | 2   | 1   | 1   |
| TiN                       | 1                        | 2  | 2  | 2  | 2   | 1   | 1   |
| 1400<br>N/mm <sup>2</sup> | 1                        | 2  | 2  | 2  | 2   | 1   |     |

Dimensions: width 240 x depth 240 x height 245 mm.

3.565,05 €