



BLUE-MASTER[®]
by *celessa*



SVASATORI

PUNTE A GRADINO A CANALI DRITTI HSS

HSS

Ø ≥ 3

Ref. AV40

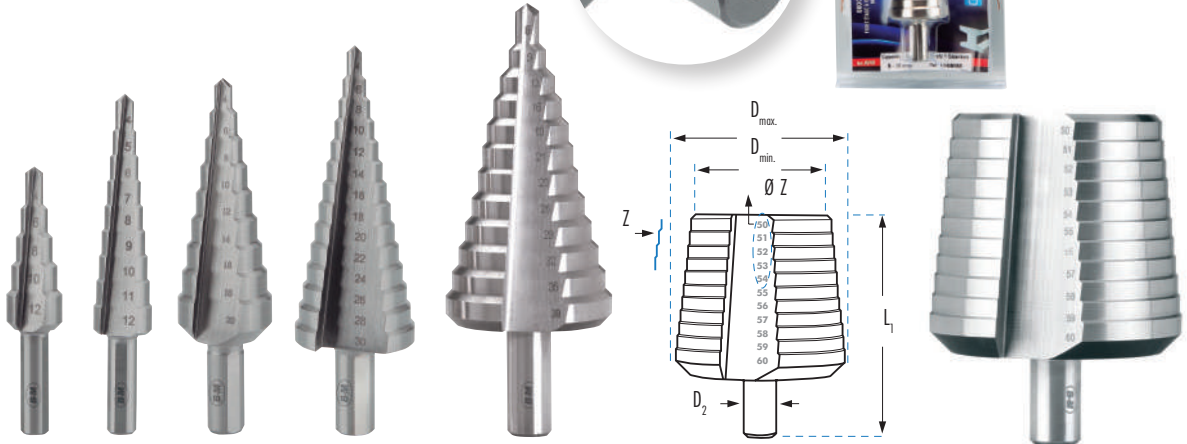
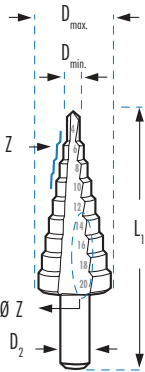

BM1

BM2

BM3

BM4

BM5

Ref. AV40BM25 / 26 / 27 / 28 / 29

AV40

	D min. mm	D max. mm	D2 mm	L1 mm	Z	Ø Z mm minore-maggiore	HSS	TiN
							€	€
AV40BM1B	4,0	12,0	6,0	65	5	4-6-8-10-12	24,14	60,88
AV40BM2B	4,0	12,0	6,0	65	9	4-5-6-7-8-9-10-11-12	25,74	65,52
AV40BM3B	4,0	20,0	8,0	69	9	4-6-8-10-12-14-16-18-20	35,01	83,65
AV40BM4B	4,0	30,0	10,0	96	14	4-6-8-10-12-14-16-18-20-22-24-26-28-30	74,03	126,27
AV40BM14	4,0	39,0	10,0	107	13	4-6-9-12-15-18-21-24-27-30-33-36-39	212,75	334,76
AV40BM16B	5,0	28,0	10,0	69	7	5-8-8,11,8-15,3-19-24,5-28	98,68	155,29
AV40BM35B	5,0	35,0	13,0	80	13	5-7-10-12-15-17-20-22-25-27-30-32-35	102,88	148,90
AV40BM11B	6,0	25,0	10,0	65	7	6-9-12-16-20-22,50-25	80,59	115,39
AV40BM10B	6,0	26,7	10,0	75	8	6-9-11,40-14-17,25-19-21,25-26,75	156,89	246,89
AV40BM17B	6,0	30,5	10,0	80	9	6-9-12,5-15,2-18,6-20,4-22,5-28,3-30,5	150,72	249,02
AV40BM12B	6,0	32,0	10,0	75	9	6-9-12-16-20-22,5-25-28,5-32	113,72	155,49
AV40BM18B	6,0	37,0	10,0	100	12	6-9-12,5-15,2-18,6-20,4-22,5-26-28,3-30,5-34-37	160,21	286,93
AV40BM5B	6,0	38,0	10,0	96	12	6-9-13-16-19-21-23-26-29-32-35-38	129,75	191,69
AV40BM13	6,0	40,0	13,0	105	16	6-11-17-23-29-30-31-32-33-34-35-36-37-38-39-40	222,46	273,33
AV40BM15B	6,5	32,5	10,0	79	9	6,50-8,50-10,50-12,50-16,50-20,50-25,50-29-32,50	131,68	184,53
AV40BM20	6,5	40,5	10,0	96	11	6,50-8,50-10,50-12,50-16,50-20,50-25,50-29	206,44	324,86
AV40BM21B	7,0	20,0	10,0	80	12	32,50-36,50-40,50	82,60	129,99
AV40BM22B	10,0	30,0	13,0	83	12	7-10-11-12-13-14-15-16-17-18-19-20	129,30	202,84
AV40BM25B	12,0	20,0	8,0	66	9	10-20-21-22-23-24-25-26-27-28-29-30	81,95	109,67
AV40BM26B	20,0	30,0	10,0	78	11	12-13-14-15-16-17-18-19-20	108,15	168,38
AV40BM27	30,0	40,0	10,0	78	11	20-21-22-23-24-25-26-27-28-29-30	151,39	215,42
AV40BM28	40,0	50,0	13,0	85	11	30-31-32-33-34-35-36-37-38-39-40	216,41	333,40
AV40BM29	50,0	60,0	13,0	85	11	40-41-42-43-44-45-46-47-48-49-50	301,40	374,38
AV40BM29	50,0	60,0	13,0	85	11	50-51-52-53-54-55-56-57-58-59-60		

PER PASSARE TUBATURE FILETTATURA GAS

AV40BM6B	6,0	32,0	10,0	75	8	6-9-11,20(1/8)-14,50(1/4)-18,20(3/8)-22,30(1/2)-27,90(3/4)-32	118,01	161,73
----------	-----	------	------	----	---	---	--------	--------

PER RIVETTI CIECHI M3 - M4 - M5 - M6 E M7

AV40BM7B	4,8	10,6	6,0	54	5	4,80-6,40-7,20-9,60-10,65	38,46	54,85
----------	-----	------	-----	----	---	---------------------------	-------	-------

PER CONDUZIONI ELETTRICHE (VECCHIA E NUOVA NORMA)

AV40PG21B	PG7	PG21	13,0	70	11	6,5-8,5-10,5-12,5(PG7)-15,2(PG9)-18,6(PG11) 20,4(PG13,5)-22,5(PG16)-25,5-18,3(PG21)-30,5	129,92	183,69
AV40PG29B	PG7	PG29	13,0	81	14	6,5-9-11-12,5(PG7)-15,2(PG9)-18,6(PG11)-20,4(PG13,5) 22,5(PG16)-26-28,3(PG21)-30,5-33-35-37(PG29)	167,84	235,46
AV40BM8B	8,5	32,5	10,0	70	12	8,5-10,5-12,5-14,5-16,5-18,5-20,5-23,5-25,5 28-30,5-32,5	98,50	151,44
AV40BM9B	8,5	40,5	12,0	84	16	8,5-10,5-12,5-14,5-16,5-18,5-20,5-23,5-25,5 28-30,5-32,5-34,5-36,5-38,5-40,5	140,26	226,14

PUNTE A GRADINO A CANALI DRITTI HSSCO

HSSCo **INOX** Ref. AVC40

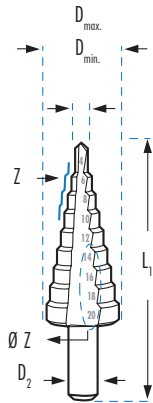

Svasatori

Rosa

	D min. mm	D max. mm	D2 mm	L1 mm	Z	Ø Z mm minore-maggiore	AVC40	
							HSSCo €	TiN €
AVC40BM1B	4,0	12,0	6,0	65	5	4-6-8-10-12	37,61	65,04
AVC40BM2B	4,0	12,0	6,0	65	9	4-5-6-7-8-9-10-11-12	40,09	70,54
AVC40BM3B	4,0	20,0	8,0	69	9	4-6-8-10-12-14-16-18-20	44,53	94,40
AVC40BM4B	4,0	30,0	10,0	96	14	4-6-8-10-12-14-16-18-20-22-24-26-28-30	87,33	171,93
AVC40BM18B	6,0	37,0	10,0	100	12	6-9-12,5-15,2-18,6-20,4-22,5-26-28,3-30,5-34-37	181,46	294,21

PUNTE A GRADINO A CANALI DRITTI HSS SDS-PLUS

NEW **HSS** **SDS Plus**

Ref. AV40BMSDS

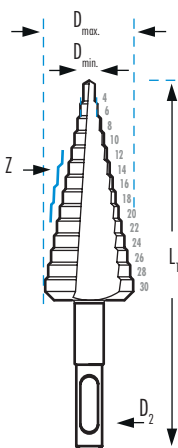

BMSDS1 BMSDS2 BMSDS3 BMSDS4

	D min. mm	D max. mm	D2 mm	L1 mm	Z	Ø Z mm minore-maggiore	AV40BMSDS	
							HSS €	TiN €
AV40BMSDS1B	4,0	12,0	8,8	95,5	5	4-6-8-10-12	25,59	64,53
AV40BMSDS2B	4,0	12,0	8,8	95,5	9	4-5-6-7-8-9-10-11-12	27,28	69,45
AV40BMSDS3B	4,0	20,0	8,8	104,0	9	4-6-8-10-12-14-16-18-20	37,11	88,67
AV40BMSDS4B	4,0	30,0	8,8	126,0	14	4-6-8-10-12-14-16-18-20-22-24-26-28-30	78,47	133,85

PUNTE A GRADINO A CANALI ELICOIDALI HSS

HSS

Ref. AV42



BM2

BM3

BM4

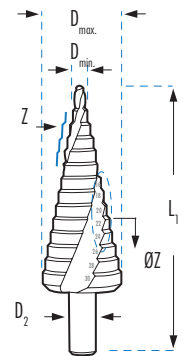

AV42

	D min. mm	D max. mm	D2 mm	L1 mm	Z	Ø Z mm minore-maggiore	HSS	TiN
							€	€
AV42BM1B	4,0	12,0	6,0	65	5	4-6-8-10-12	34,66	53,73
AV42BM2B	4,0	12,0	6,0	68	9	4-5-6-7-8-9-10-11-12	34,28	58,96
AV42BM3B	4,0	20,0	8,0	69	9	4-6-8-10-12-14-16-18-20	45,32	75,25
AV42BM4B	4,0	30,0	10,0	96	14	4-6-8-10-12-14-16-18-20-22-24-26-28-30	80,13	122,15
AV42BM5B	6,0	38,0	10,0	96	12	6-9-13-16-19-21-23-26-29-32-35-38	167,54	230,09
AV42BM11B	6,0	25,0	10,0	65	7	6-9-12-16-20-22,50-25	84,48	122,47
AV42BM12B	6,0	32,0	10,0	75	9	6-9-12-16-20-22,5-25-28,5-32	132,49	172,85
AV42BM13	6,0	40,0	13,0	105	16	6-11-17-23-29-30-31-32-33-34-35-36-37-38-39-40	272,15	53,73
AV42BM8B	8,5	32,5	10,0	70	12	8,5-10,5-12,5-14,5-16,5-18,5-20,5-23,5 25,5-28-30,5-32,5	103,28	149,72
AV42BM9B	8,5	40,5	12,0	84	16	8,5-10,5-12,5-14,5-16,5-18,5-20,5-23,5 25,5-28-30,5-32,5-34,5-36,5-38,5-40,5	163,59	237,14

PUNTE A GRADINO A CANALI ELICOIDALI HSS MEGA SCALINATA

NEW
HSS

Ref. AV42BM7



AV42BM702B AV42BM703B AV42BM704B

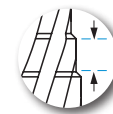

SCALINO 10 mm

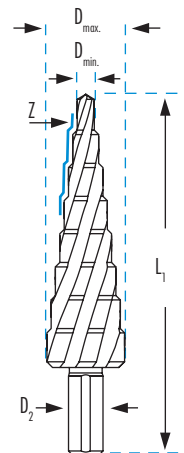
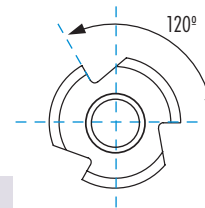

AV42

	D min. mm	D max. mm	D2 mm	L1 mm	Z	Ø Z mm minore-maggiore	HSS	TiN
							€	€
AV42BM702B	6,0	12,0	6,0	105	7	6-7-8-9-10-11-12	45,95	51,05
AV42BM703B	6,0	20,0	10,0	120	8	6-8-10-12-14-16-18-20	72,11	80,12
AV42BM704B	6,0	27,0	12,0	125	8	6-9-12-15-18-21-24-27	94,88	105,42

PUNTE A GRADINO HSS



STEP CUT

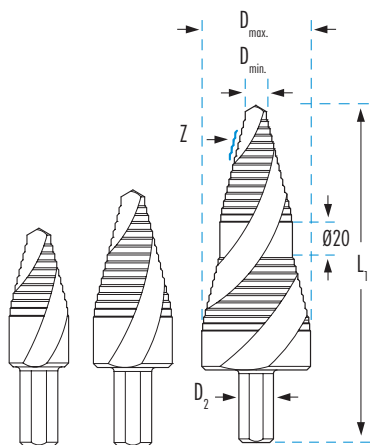

SCALINO 2 mm



AV40BM37

AV40BM38

AV40BM36

	D min. mm	D max. mm	D ₂ mm	L1 mm	Z	Ø Z mm minore-maggiore	AV40BM	
							HSS €	TiN €
AV40BM37B	6,0	15,0	9,5	55	11	6-7-8-9-10-11-12-13-14-14,5-15	27,75	36,42
AV40BM38B	6,0	20,0	9,5	65	16	6-7-8-9-10-11-12-13-14-15-16-17-18-19-19,5-20	41,49	57,02
AV40BM36B	6,0	30,0	9,5	93	27	6-7-8-9-10-11-12-13-14-15-16-17-18-19-19,5-20-21-22-23-24-25-26-27-28-29-29,5-30	102,31	147,33

CODOLO ESAGONALE 1/4"

	D min. mm	D max. mm	Hexagon	L1 mm	Z	Ø Z mm minore-maggiore	AV41	
							HSS €	TiN €
AV41BM2B	4,0	12,0	1/4"	72	9	4-5-6-7-8-9-10-11-12	34,28	58,96
AV41BM3B	4,0	20,0	1/4"	81	9	4-6-8-10-12-14-16-18-20	45,32	75,25
AV41BM4B	4,0	30,0	1/4"	105	14	4-6-8-10-12-14-16-18-20-22-24-26-28-30	80,13	122,15



Ref. AV41BM2B

SERIE CORTA Massimo 2 mm di spessore

	D min. mm	D max. mm	D ₂ mm	L1 mm	Z	Ø Z mm minore-maggiore	AV41C	
							HSS €	TiN €
AV41CBM2B	4,0	12,0	6,0	48	9	4-5-6-7-8-9-10-11-12	33,24	53,56
AV41CBM3B	4,0	20,0	8,0	58	9	4-6-8-10-12-14-16-18-20	41,28	69,22
AV41CBM4B	4,0	30,0	10,0	72	14	4-6-8-10-12-14-16-18-20-22-24-26-28-30	80,75	134,71



Ref. AV41CBM3B

PUNTE A GRADINO HSS CARATTERISTICHE SPECIALI

HSS

AVVITAMENTI METRICI PER CAVI

	DIN	D min. mm	D max. mm	D2 mm	L1 mm	Z	Ø Z mm minore-maggiore	AV45	
								HSS €	TiN €
AV45BM0B	60423	5,3	30,5	10,0	79	9	5,3-7-9-10,5-14,5-18,5-23,5-27-30,5	188,98	243,70
AV45BM2B	60423	5,3	38,5	10,0	96	11	5,3-7-9-10,5-14,5-18,5-23,5-27-30,5-34,5-38,5	227,25	287,13



Ref. AV45BM2B3

A GRADINO DRITTA A 3 TAGLIENTI

	D min. mm	D max. mm	D2 mm	L1 mm	Z	Ø Z mm minore-maggiore	AV43	
							HSS €	TiN €
AV43BM1B	4,0	12,0	6,0	65	9	4-5-6-7-8-9-10-11-12	32,06	41,95
AV43BM2B	4,0	20,0	8,0	75	9	4-6-8-10-12-14-16-18-20	43,96	68,10
AV43BM3B	4,0	30,0	10,0	100	14	4-6-8-10-12-14-16-18-20-22-24-26-28-30	88,86	145,33



Ref. AV43BM3B

PUNTA A GRADINO CON PUNTA PILOTA INTERCAMBIABILE

	D min. mm	D max. mm	D2 mm	L1 mm	Z	Ø Z mm minore-maggiore	AV4	
							HSS €	
AV4BM3040	30,0	40,0	13,0	76	11	30-31-32-33-34-35-36-37-38-39-40	173,19	
AV4BM4050	40,0	50,0	13,0	76	11	40-41-42-43-44-45-46-47-48-49-50	250,17	
AV4BM5060	50,0	60,0	13,0	76	11	50-51-52-53-54-55-56-57-58-59-60	317,55	



Ref. AV4BM3040

PUNTA PILOTA



	DESCRIZIONE	BAV4BM €
BAV4BM	10X35mm	11,22

PUNTE A SVASARE PER TUBI E LAMIERE HSS E HSSCO

HSS **HSSCo** Ref. AV30 Ref. AVC30  

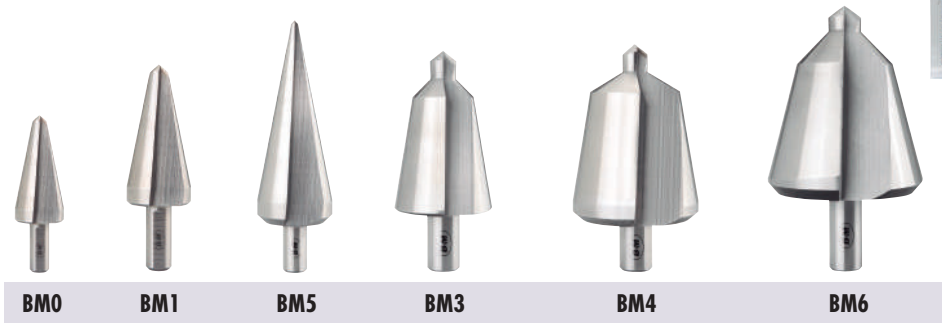

D min. mm	D max. mm	D2 mm	L1 mm		AV30		AVC30		
					HSS €	TiN €	HSSCo €	TiN €	
3,0	14,0	6,0	58	AV30BM0B	18,03	42,01	AVC30BM0B	38,91	50,82
3,0	22,5	8,0	85	AV30BM8B	54,84	99,37			
3,0	31,0	10,0	102	AV30BM5B	78,80	133,66			
5,0	25,4	10,0	87	AV30BM9B	66,08	126,27			
6,0	20,0	8,0	63	AV30BM1B	29,66	61,32	AVC30BM1B	51,60	78,36
16,0	30,0	10,0	79	AV30BM2B	52,46	101,46	AVC30BM2B	85,13	113,52
26,0	40,0	13,0	86	AV30BM3B	108,52	185,89	AVC30BM3B	172,05	239,05
36,0	50,0	13,0	89	AV30BM4	174,83	269,71			
40,0	61,0	13,0	98	AV30BM6	289,65	451,08			

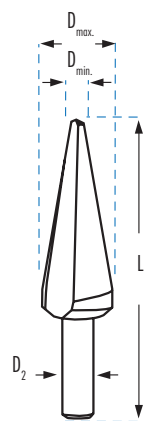

* Le referenze che terminano in B si somministrano in blister.

PUNTE A SVASARE PER LAMIERA HSS CARATTERISTICHE SPECIALI

HSS Ref. AG Punta a svasare per il taglio di tubi e lamiere in acciaio, leghe leggere e materie plastiche. Indicato fino a 5mm di profondità.

HSS Ref. AV31

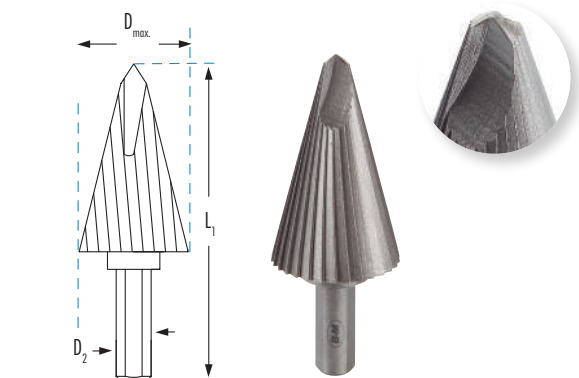

PER LAMIERE, SPECIALE PER MECCANICI, ELETTRAUTO, CARROZZIERI

COLLARE DI ARRESTO PROFONDITÀ

	D max. mm	D2 mm	L1 mm	N° denti	AG
					HSS €
AG2500	25,0	8,0	72	20	28,42
AG3200	32,0	10,0	81	30	42,67
AG4500	45,0	10,0	94	36	70,48

	D min. mm	D max. mm	D2 mm	L1 mm	AV31	
					HSS €	TiN €
AV31BMOB	3,0	7,8	6,0	48	33,69	51,00
AV31BM1B	3,0	10,2	6,0	52	44,24	69,37
AV31BM2B	3,0	11,8	6,0	56	49,24	87,00

SVASATORI A 3 CANALI

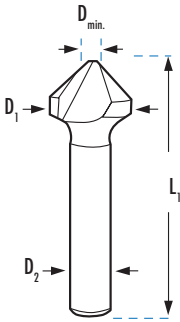
DIN
335C

3Z



MATERIALE				FINITURA				APPLICAZIONE					
D1 mm-"	D min. mm	D2 mm	L1 mm	AV6	AV16	AV37	AV7	AV38	AV15				
				HSS	HSS	HSS	HSS	HSSCo	HSSCo		HSS		
						TiN	TiAlN		TiAlSiN				
				USO GENERALE	USO GENERALE	USO GENERALE	USO GENERALE	USO GENERALE	INOX Plus				
				€	€	€	€	€	€	L1 mm	€		
4,00	1,3	4,0	40	AV60400	11,18								
4,30	1,3	4,0	40	AV60430	11,42	AV160430	17,90	AV370430	25,78	AV70430	19,99	AV380430	24,09
5,00	1,5	4,0	40	AV60500	11,42	AV160500	17,90	AV370500	25,78	AV70500	19,99	AV380500	24,09
5,30	1,5	4,0	40	AV60530	11,42	AV160530	17,90	AV370530	25,78	AV70530	19,99	AV380530	24,09
5,80	1,5	5,0	45	AV60580	10,71	AV160580	15,72	AV370580	24,19	AV70580	17,40	AV380580	20,44
5,80	1,5	6,0	45	AV60580-6	11,22								
6,00	1,5	5,0	45	AV60600	11,22	AV160600	15,38	AV370600	24,19	AV70600	16,72	AV380600	20,19
6,00	1,5	6,0	45	AV60600-6	11,85								
6,30	1,5	5,0	45	AV60630	11,28	AV160630	13,16	AV370630	24,19	AV70630	16,40	AV380630	20,08
6,30	1,5	6,0	45	AV60630-6	12,25								
1/4"	1,5	6,0	45	AV6P1/4	12,62								
7,00	1,8	6,0	50	AV60700	14,09	AV160700	20,54	AV370700	32,27	AV70700	19,99	AV380700	27,15
7,30	1,8	6,0	50	AV60730	12,90	AV160730	20,54	AV370730	32,27	AV70730	19,99	AV380730	27,15
5/16"	2,0	6,0	50	AV6P5/16	13,34								
8,00	2,0	6,0	50	AV60800	13,15	AV160800	20,54	AV370800	32,27	AV70800	20,19	AV380800	27,23
8,30	2,0	6,0	50	AV60830	13,23	AV160830	20,54	AV370830	32,27	AV70830	19,82	AV380830	27,93
9,00	2,2	6,0	50	AV60900	13,65								
9,40	2,2	6,0	50	AV60940	14,38	AV160940	23,18	AV370940	36,17	AV70940	23,37	AV380940	31,80
3/8"	2,5	6,0	50	AV6P3/8	15,71								
10,00	2,5	6,0	50	AV61000	15,34	AV161000	23,18	AV371000	36,17	AV71000	23,37	AV381000	31,80
10,40	2,5	6,0	50	AV61040	15,83	AV161040	23,18	AV371040	36,17	AV71040	24,08	AV381040	31,71
11,50	2,8	8,0	56	AV61150	16,20	AV161150	24,54	AV371150	38,89	AV71150	25,79	AV381150	34,47
12,00	2,8	8,0	56	AV61200	17,06	AV161200	25,63	AV371200	40,83	AV71200	27,27	AV381200	34,47
12,40	2,8	8,0	56	AV61240	16,23	AV161240	22,89	AV371240	38,89	AV71240	25,49	AV381240	34,78
1/2"	2,9	8,0	56	AV6P1/2	17,36								
13,40	2,9	8,0	56	AV61340	18,98	AV161340	25,36	AV371340	40,17	AV71340	27,81	AV381340	34,99
14,40	2,4	8,0	56	AV61440	19,31								
15,00	3,2	8,0	60	AV61500-8	20,27								
15,00	3,2	10,0	60	AV61500	19,44	AV161500	31,96	AV371500	52,93	AV71500	35,42	AV381500	40,87
5/8"	3,2	8,0	60	AV6P5/8	20,86								
16,50	3,2	8,0	60	AV61650-8	21,74								
16,50	3,2	10,0	60	AV61650	19,88	AV161650	28,41	AV371650	54,99	AV71650	34,94	AV381650	46,61
19,00	3,5	10,0	63	AV61900	28,00	AV161900	42,70	AV371900	66,74	AV71900	52,39	AV381900	56,91
3/4"	3,5	8,0	63	AV6P3/4	30,24								
20,50	3,5	8,0	63	AV62050-8	31,16								
20,50	3,5	10,0	63	AV62050	29,41	AV162050	35,87	AV372050	68,74	AV72050	48,84	AV382050	57,64
23,00	3,8	10,0	67	AV62300	40,48	AV162300	49,67	AV372300	76,92	AV72300	63,83	AV382300	66,95
25,00	3,8	10,0	67	AV62500	38,68	AV162500	50,38	AV372500	77,73	AV72500	64,97	AV382500	67,83
1"	3,8	10,0	67	AV6P1	40,54								
26,00	3,8	10,0	67	AV62600	45,58	AV162600	54,62						
28,00	4,0	12,0	71	AV62800	51,79	AV162800	64,04	AV372800	100,58	AV72800	92,79	AV382800	105,63
30,00	4,2	12,0	71	AV63000	59,72	AV163000	66,45	AV373000	106,50	AV73000	98,14	AV383000	109,95
31,00	4,2	12,0	71	AV63100	59,74	AV163100	70,59	AV373100	114,35	AV73100	98,14	AV383100	110,97
40,00	4,5	13,0	112	AV64000	134,59	AV164000	155,05	AV374000	165,50	AV74000	143,62	AV384000	153,41
45,00	4,5	13,0	116	AV64500	140,45								
50,00	5,0	13,0	125	AV65000	157,96								

NEW

**DIN
335C**



ANTIVIBRANTI

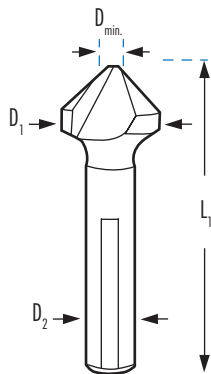
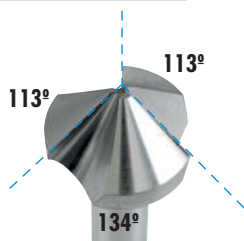

				AV66	AV67	AV99	AV55	AV6MD	AV66MD	AV55MD
MATERIALE				HSSCo	HSSCo	HSSCo	HSSCo	MD	MD	MD
FINITURA					TiAlN	TiAlN				
APPLICAZIONE						 INOX <i>Spherulite</i>				
				3Z	3Z	3Z	5Z	3Z	3Z	5Z
D1 mm	D min. mm	D2 mm	L1 mm	€	€	€	€	€	€	€
4,30	1,3	4,0	40					67,74		
5,30	1,5	4,0	40					65,22		
6,00	1,5	5,0	45					67,39		
6,30	1,5	5,0	45	23,88	31,04	41,70	4Z 31,04	72,86	81,35	4Z 101,69
8,00	2,0	6,0	50			54,96		77,62		
8,30	2,0	6,0	50	24,05	31,27	56,25	4Z 31,27	82,78	92,43	4Z 115,53
10,00	2,5	6,0	50			60,36		85,56		
10,40	2,5	6,0	50	29,23	37,99	63,85	4Z 37,99	90,29	100,81	4Z 126,01
11,50	2,8	8,0	56			68,55				
12,40	2,8	8,0	56	30,94	40,22	69,41	40,22	94,15	105,12	131,40
14,40	2,4	8,0	56	37,36	48,57					
15,00	3,2	10,0	60	42,99	55,88	85,86		98,06		
16,50	3,2	10,0	60	43,42	56,44	96,83	56,44	103,11	115,13	143,91
19,00	3,5	10,0	63			109,80				
20,50	3,5	10,0	63	54,53	70,89	119,75	70,89	142,97	159,63	199,54
23,00	3,8	10,0	67			130,15				
25,00	3,8	10,0	67	78,85	102,51	140,91	102,51	233,30	260,48	325,59
31,00	4,2	12,0	71	109,57	142,44	170,32	142,44	263,25	293,92	367,40
40,00	6,5	13,0	80	216,13	280,97	324,82		457,06*		
50,00	5,0	16,0	125	355,36	461,97					

* Codolo di 16 mm



Svasatori a taglio variabile antivibranti.

Gli svasatori di nuova generazione migliorano la qualità della finitura in esercizio e ne prolungano la vita utile.

La leggera asimmetria nei tagli della svasatura aumenta le prestazioni e riduce notevolmente le vibrazioni durante il funzionamento.

La disposizione dei tagli nella svasatura contribuisce ad un'operazione di taglio progressiva, aumenta le prestazioni dell'utensile, migliorando la finitura finale, minimizzando le irregolarità.

I tre piani di trascinamento impediscono lo scivolamento, garantendo una presa salda della svasatura nel mandrino del trapano, evitando possibili slittamenti e scivolamenti durante l'uso.

**HARDOX
500**

Svasatura di HARDOX500 e materiali con durezza estrema.

Per gli svasatori in materiali ad alta durezza e HARDOX500, sono consigliati gli svasatori 5Z AV55 e AV55MD.

Modalità d'azione: È molto importante, in questa tipologia di materiali, che prima di iniziare a ruotare la svasatrice per iniziare il taglio, l'utensile sia già a contatto con il materiale. Successivamente inizia a ruotare ed aumenta progressivamente la velocità man mano che inizia a penetrare nel materiale. In questo modo si evita qualsiasi shock iniziale, dove è elevata la possibilità di smussamento del tagliente all'avvicinarsi dell'utensile.

SVASATORI HSS COLODO CILINDRICO 60°, 75° E 120°

3Z

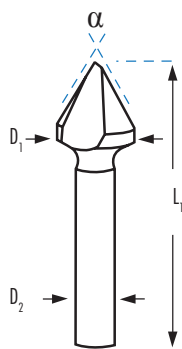

MATERIALE				AV8		AV9		AV10	
NORMA				HSS		HSS		HSS	
ANGOLO DI TAGLIO				DIN 334C		NORMA CELESA		NORMA CELESA	
ANGOLO DI TAGLIO				60°		75°		120°	
D1 mm	D min mm	D2 mm	L1 mm		€		€		€
6,30	1,5	5,0	45	AV80630	21,58	AV90630	16,62	AV100630	17,69
8,00	2,0	6,0	50	AV80800	23,73				
8,30	2,0	6,0	50			AV90830	22,65	AV100830	24,36
10,00	2,5	6,0	50	AV81000	25,87				
10,40	2,5	6,0	50			AV91040	26,75	AV101040	28,48
12,40	2,8	8,0	56	AV81250	28,68	AV91240	29,56	AV101240	34,08
16,50	3,2	10,0	60	AV81600	32,49	AV91650	37,09	AV101650	43,13
20,50	3,5	10,0	63	AV82000	43,39	AV92050	54,57	AV102050	58,21
25,00	3,8	10,0	67	AV82500	57,81	AV92500	68,80	AV102500	76,45
40,00	6,5	13,0	67	AV84000	166,04	AV94000	149,70	AV104000	176,42

SVASATORI MULTITAGLIO CODOLO CILINDRICO 60°, 90° E 120°

5Z

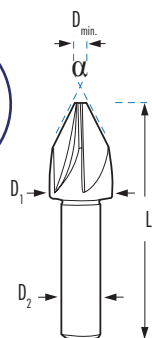

MATERIALE				AV12		AV11		AV13				
DIN				HSS		HSS		HSS				
ANGOLO DI TAGLIO				DIN 334A		DIN 335A		DIN 347A				
ANGOLO DI TAGLIO				60°		90°		120°				
D1 mm	D min mm	D2 mm	N° Z	L1 mm	€	L1 mm	€	L1 mm	€			
8,00	2,5	8,0	5	AV120800	48	18,86	AV110800	44	14,17	AV130800	44	18,80
12,50	2,8	8,0	5	AV121250	52	26,40	AV111250	48	20,76	AV131250	48	27,58
16,00	3,0	10,0	5	AV121600	60	44,28	AV111600	56	34,88	AV131600	56	46,29
20,00	3,5	10,0	5	AV122000	64	57,11	AV112000	60	44,92	AV132000	60	59,68
25,00	3,5	10,0	5	AV122500	69	79,95	AV112500	65	62,89	AV132500*	65	81,19

* D2: 12,00 mm

SVASATORI HSS E HSSCO PER SBAVARE CON FORO

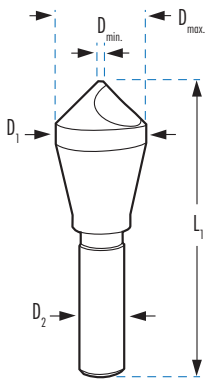

Svasatori

Rosa

MATERIALE					AV1		AV1T		AV2		AV2T		AV1-60	
FINITURA					HSS		HSS		HSSCo		HSSCo		HSS	
ANGOLO DI TAGLIO					90°		TiN 90°		90°		TiN 90°		60°	
D1 mm	Dmin mm	Dmax mm	D2 mm	L1 mm	€	€	€	€	€	€	€	€	€	
6,35	2,0	5,0	6,35	45	AV100	14,65	AV100T	26,48	AV200	24,92	AV200T	41,91	AV100-60	26,27
10,00	2,0	5,0	6,00	45	AV101	17,08	AV101T	26,48	AV201	25,73	AV201T	41,91	AV101-60	32,81
14,00	6,0	13,0	8,00	50	AV102	20,56	AV102T	35,43	AV202	29,97	AV202T	52,26	AV102-60	39,82
20,00	8,0	18,0	10,00	65	AV103	34,77	AV103T	59,87	AV203	53,58	AV203T	88,47	AV103-60	45,44
27,00	11,0	25,0	12,00	85	AV104	68,65	AV104T	108,75	AV204	87,30	AV204T	139,35	AV104-60	79,16
30,00	12,0	28,0	15,00	95	AV105	104,85	AV105T	186,80	AV205	138,71	AV205T	239,45	AV105-60	129,72
35,00	14,0	33,0	15,00	100	AV106	168,56	AV106T	267,69	AV206	232,37	AV206T	402,70	AV106-60	205,56
40,00	16,0	38,0	15,00	110	AV107	230,15	AV107T	376,21	AV207	267,37	AV207T	431,46	AV107-60	278,59
45,00	18,0	42,0	15,00	120	AV108	320,21	AV108T	479,80	AV208	401,81	AV208T	572,36	AV108-60	360,06
50,00	20,0	48,0	15,00	130	AV109	413,39	AV109T	596,89	AV209	535,53	AV209T	718,60	AV109-60	438,70

SVASATORE CONICO 90° MULTITAGLIO

Ref. FC

TiAIN **MD**

D1 mm	D2 mm	L mm	L2 mm	D3 mm	Z	FC	€
0,5	0,1	39,0	3,0	3,0	3	FC0050	68,80
0,6	0,1	39,0	3,0	3,0	3	FC0060	68,80
0,7	0,1	39,0	3,0	3,0	3	FC0070	68,80
0,8	0,1	39,0	3,0	3,0	3	FC0080	68,80
0,9	0,1	39,0	3,0	3,0	3	FC0090	68,80
1,0	0,1	39,0	3,0	3,0	3	FC0100	66,41
1,5	0,1	39,0	4,5	3,0	3	FC0150	66,41
2,0	0,1	39,0	6,0	3,0	3	FC0200	66,41
2,5	0,1	39,0	7,5	3,0	3	FC0250	66,41
3,0	0,1	39,0	-	3,0	3	FC0300	66,41
4,0	0,8	54,0	-	4,0	4	FC0400	68,80
6,0	0,8	57,0	-	6,0*	4	FC0600	72,35
8,0	0,8	63,0	-	8,0*	5	FC0800	79,45
10,00	1,0	72,0	-	10,0*	6	FC1000	94,87
12,00	1,2	83,0	-	12,0*	6	FC1200	139,95
16,00	1,6	92,0	-	16,0*	6	FC1600	250,26
20,00	2,0	104,0	-	20,0*	6	FC2000	457,81

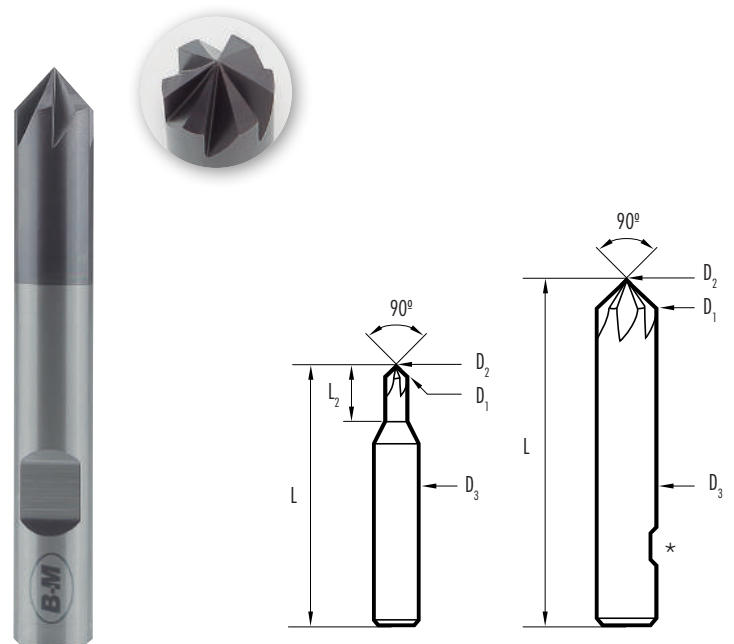

*Con piano di trascinamento

SVASATORI CODOLO CONICO

3Z

Ref. AV17

DIN
335D

HSS



90°

Ref. AV17MD

DIN
335D

MD



90°

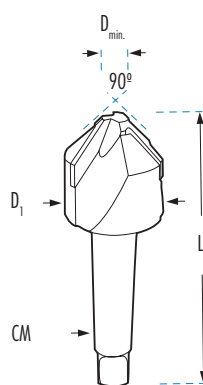
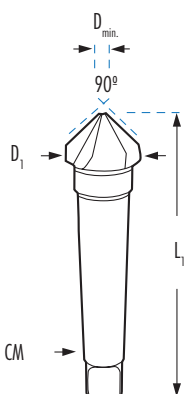

AV17

D1 mm	D min. mm	L1 mm	CM	€
16,50	4,0	90	1	85,29
20,50	3,5	100	2	101,53
25,00	3,8	106	2	102,58
31,00	4,2	112	2	106,18
40,00	10,0	140	3	153,15
50,00	14,0	150	3	192,77
63,00	16,0	180	4	340,03
80,00	22,0	190	4	606,07
100,00	25,0	210	4	1.576,88

AV17MD

D1 mm	D min. mm	L1 mm	CM	€
63,00	16,0	190	4	1.571,48*
80,00	22,0	190	4	1.918,48*

*Fino ad esaurimento scorte

SVASATORI MULTITAGLIO CODOLO CONICO

MULTI
TAGLIO

Ref. AV23

DIN
334B

60°

Ref. AV18

DIN
335B

90°

Ref. AV24

DIN
347B

120°

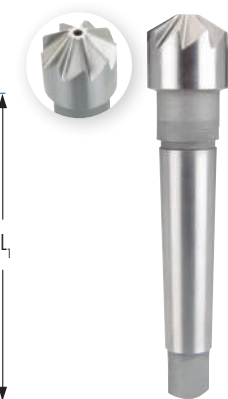
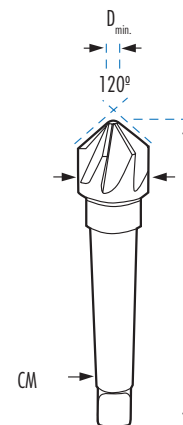
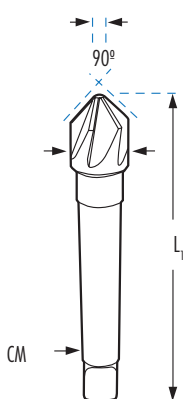
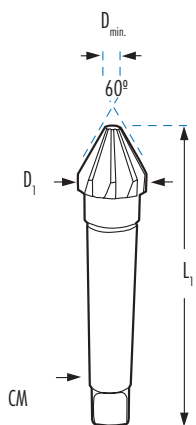

AV23

D1 mm	D min. mm	L1 mm	CM	Z	HSS	€
16,00	3,2	93	1	7	HSS	68,60
20,00	4,0	116	2	7	HSS	80,31
25,00	7,0	121	2	9	HSS	87,96
31,50	9,0	124	2	9	HSS	120,29
40,00	12,5	150	3	11	HSS	220,13
50,00	16,0	153	3	13	HSS	263,14
63,00	20,0	185	4	15	HSS	402,85
80,00	25,0	196	4	17	HSS	622,60

AV18

D1 mm	D min. mm	L1 mm	CM	Z	HSS	€
16,00	3,2	93	1	7	HSS	69,96
20,00	4,0	116	2	7	HSS	81,82
25,00	7,0	121	2	9	HSS	89,71
31,50	9,0	124	2	9	HSS	122,72
40,00	12,5	150	3	11	HSS	224,60
50,00	16,0	153	3	13	HSS	268,35
63,00	20,0	185	4	15	HSS	385,26
80,00	25,0	196	4	17	HSS	635,10
100,00	22,0	190	4	20	HSS	1.711,98

AV24

D1 mm	D min. mm	L1 mm	CM	Z	HSS	€
16,00	3,2	93	1	7	HSS	71,23
20,00	4,0	116	2	7	HSS	83,39
25,00	7,0	121	2	9	HSS	95,78
31,50	9,0	124	2	9	HSS	124,93
40,00	12,5	150	3	11	HSS	198,93
50,00	16,0	153	3	13	HSS	256,94
63,00	20,0	185	4	15	HSS	418,34
80,00	25,0	196	4	17	HSS	646,54
100,00	27,0	210	4	3	HSS	1.696,85

SVASATORI A 1 CANALE

HSS

CODOLO CILINDRICO
Ref. AV27
Ref. AV29



HSS

CODOLO CONICO
Ref. AV34
Ref. AV28

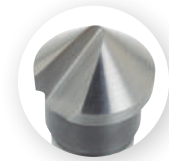

1Z

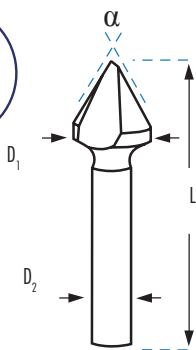

1Z

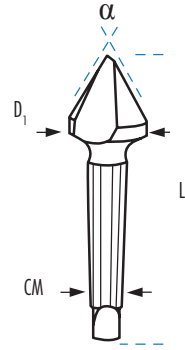





AV27

AV29

AV34

AV28

	D1 mm	D2 mm	L1 mm	 €	 €
AV270600	6,0	5,0	45	14,82	AV290600 27,32
AV270800	8,0	6,0	46	15,64	AV290800 28,62
AV271000	10,0	8,0	46	16,57	AV291000 29,97
AV271200	12,0	8,0	46	19,31	AV291200 33,66
AV271600	16,0	8,0	46,5	22,99	AV291600 40,99
AV272000	20,0	10,0	47	31,42	AV292000 52,67
AV272500	25,0	10,0	51	41,40	AV292500 82,96
AV273000	30,0	12,0	71	59,68	AV293000 108,33
AV274000	40,0	13,0	89	155,55	AV294000 188,30
AV275000	50,0	13,0	98	192,04	AV295000 281,31

	D1 mm	CM	L1 mm	 €	 €
AV341600	16,0	1	92	71,22	AV281600 68,14
AV342000	20,0	2	107	89,25	AV282000 74,65
AV342500	25,0	2	110	114,94	AV282500 110,67
AV343000	30,0	2	114	130,61	AV283000 145,85
AV344000	40,0	3	145	210,15	AV284000 192,03
AV345000	50,0	3	152	306,86	AV285000 291,62

SVASATORI ESTERNI A 3 TAGLIANTI

3Z

Ref. AVX

HSS



90°

Ref. AVX-60

HSS



60°

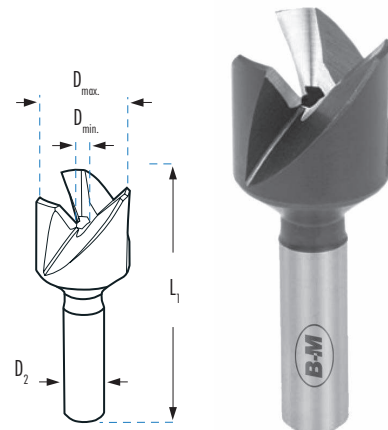

AVX

D _{max.} mm	D _{min.} mm	D2 mm	L1 mm		€
12,00	4,0	8,0	55	AVX1	48,21
20,00	8,0	10,0	60	AVX2	83,63
28,00	10,0	13,0	70	AVX3	118,61
40,00	12,0	CM2	125	AVX4	248,58
50,00	15,0	CM3	130	AVX5	347,31

AVX-60

D _{max.} mm	D _{min.} mm	D2 mm	L1 mm		€
8,00	3,0	8,0	55	AVX1-60	46,35
15,00	6,0	10,0	60	AVX2-60	92,02
28,00	10,0	13,0	75	AVX3-60	137,91

SVASATORE ESTERNO PER RIPARAZIONE DEI FILETTI DI ATTACCO

Ref. AVEXT

HSS



60°



Min.-Max.		L1 mm		€
M8-M18	1/4"	75	AVEXT	28,11

SVASATORE ESTERNO PER RIPARAZIONE DEI FILETTI DI ATTACCO DI METALLO DURO

NEW

Ref. AVMDEXT

MD



60°

INOX



Min.-Max.			€
5-25 mm	1/4"	AVMDEXT	32,36

SVASATORI PER SEDI DI VITI "ALLEN"

CODOLO CILINDRICO

Ref. AV2

DIN 373

HSS

NOTA: La lunghezza di taglio si intende senza guida.

* La regolazione grossa si utilizza per svasare fori filettati.

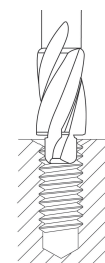
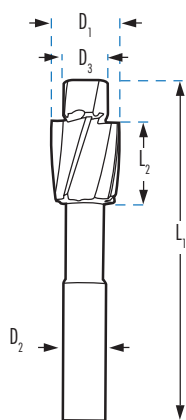

PER SVASARE FORI FILETTATI



AV2M

AV2MM

AV2GM

REGOLAZIONE						FINE		MEDIA		FORO FILETTATO			
	D1 mm	D2 mm	L1 mm	L2 mm		D3 mm	€	D3 mm	€	D3 mm	€		
M3	6,0	5,0	71	14	AV2M3	3,2	26,22	AV2MM3	3,4	27,70	AV2GM3	2,5	27,70
M4	8,0	5,0	71	14	AV2M4	4,3	26,22	AV2MM4	4,5	27,70	AV2GM4	3,3	27,70
M5	10,0	8,0	80	18	AV2M5	5,3	26,22	AV2MM5	5,5	27,70	AV2GM5	4,2	27,70
M6	11,0	8,0	80	18	AV2M6	6,4	29,56	AV2MM6	6,6	31,22	AV2GM6	5,0	31,22
M7	20,0	12,7	90	20	AV2M7	7,4	54,60						
M8	15,0	12,5	100	22	AV2M8	8,4	36,66	AV2MM8	9,0	38,70	AV2GM8	6,8	38,70
M10	18,0	12,5	100	22	AV2M10	10,5	43,63	AV2MM10	11,0	46,08	AV2GM10	8,5	46,08
M11	22,0	18,8	100	22	AV2M11	11,5	58,08						
M12	20,0	12,5	100	22	AV2M12	13,0	50,90	AV2MM12	14,0	53,76	AV2GM12	10,2	53,76
M14	24,0	12,5	100	22	AV2M14	15,0	79,62	AV2MM14	15,5	84,08	AV2GM14	12,0	84,08
M16	26,0	12,5	100	22	AV2M16	17,0	87,58	AV2MM16	17,5	92,48	AV2GM16	14,0	92,48

TESTA CONICA CON GUIDA

Ref. AV3

DIN 1866

HSS

NOTA: La lunghezza di taglio si intende senza guida

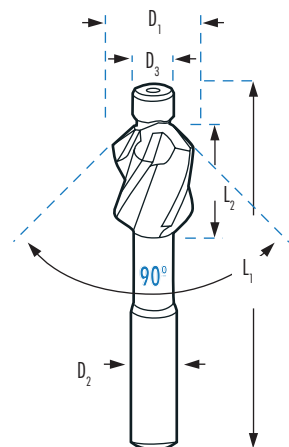

REGOLAZIONE						AV3	
	D1 mm	D2 mm	L1 mm	L2 mm		D3 mm	FINE €
M3	6,3	6,0	71	14,0	AV3M3	3,2	25,05
M4	8,3	8,0	71	14,0	AV3M4	4,3	34,10
M5	10,4	10,0	80	18,0	AV3M5	5,3	36,54
M6	12,4	10,0	80	18,0	AV3M6	6,4	41,55
M8	16,5	12,0	100	22,0	AV3M8	8,4	50,83
M10	20,5	12,0	100	22,0	AV3M10	10,5	55,00
M12	24,5	13,0	110	25,0	AV3M12	13,0	67,02

SVASATORI PER SEDI DI VITI "ALLEN"

CODOLO CONICO

DIN
375

HSS

Ref. AV5

NOTA: La lunghezza di taglio si intende senza guida.

* La regolazione grossa si utilizza per svasare fori filettati.

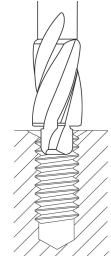
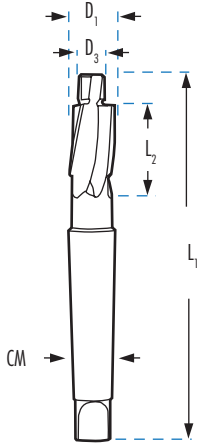

PER SVASARE FORI FILETTATI



REGOLAZIONE					AV5M			AV5MM			AV5GM			
	D1 mm	CM	L1 mm	L2 mm		D3 mm	FINE €		D3 mm	MEDIA €		D3 mm	FORO FILETTATO €	
M8	15,0	2	132	22	AV5M8	8,4	72,37					AV5GM8	6,8	72,37
M10	18,0	2	140	25	AV5M10	10,5	74,28	AV5MM10	11,0	74,28		AV5GM10	8,5	74,28
M12	20,0	2	140	25	AV5M12	13,0	82,17	AV5MM12	14,0	82,17		AV5GM12	10,2	82,17
M14	24,0	2	150	30	AV5M14	15,0	114,07	AV5MM14	15,5	114,07		AV5GM14	12,0	114,07
M16	26,0	3	180	35	AV5M16	17,0	133,94	AV5MM16	17,5	133,94		AV5GM16	14,0	133,94
M18	30,0	3	180	35	AV5M18	19,0	144,52	AV5MM18	20,0	144,52		AV5GM18	15,5	144,52
M20	33,0	3	190	40	AV5M20	21,0	157,47	AV5MM20	22,0	157,47		AV5GM20	17,5	157,47
M22	36,0	3	190	40	AV5M22	23,0	191,90	AV5MM22	24,0	191,90		AV5GM22	19,5	191,90
M24	40,0	3	190	40	AV5M24	25,0	231,99	AV5MM24	26,0	231,99		AV5GM24	21,0	231,99
M27	46,0	4	255	50	AV5M27	30,0	263,61							
M30	48,0	4	255	50	AV5M30	33,0	318,88							

APPLICAZIONI DEI TIPI DI REGOLAZIONE: FINE, MEDIA E FORO FILETTATO

T₁: Viti testa cilindrica DIN 84 e DIN 7984
Viti Autofilettanti DIN 7513
DIN 7500

T₂: Viti testa cilindrica DIN 6912
T₃: Viti testa cilindrica DIN 912

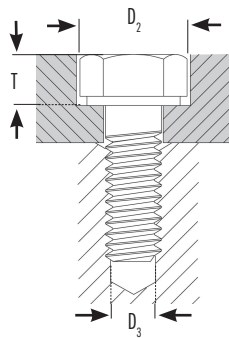

	FINE	MEDIA	FORO FILETTATO				
FILETTATURE METRICHE	D3 mm	D3 mm	D3 mm	D2 mm	T1 mm	T2 mm	T3 mm
M3	3,2	3,4	2,5	6,0	2,4	--	3,4
M4	4,3	4,5	3,3	8,0	3,2	3,4	4,6
M5	5,3	5,5	4,2	10,0	4,0	4,2	5,7
M6	6,4	6,6	5,0	11,0	4,7	4,8	6,8
M8	8,4	9,0	6,8	15,0	6,0	6,0	6,0
M10	10,5	11,0	8,5	18,0	7,0	7,5	11,0
M12	13,0	13,5	10,2	20,0	8,0	8,5	13,0
M14	15,0	15,5	12,0	24,0	9,0	9,5	15,0
M16	17,0	17,5	14,0	26,0	10,5	11,5	17,5
M18	19,0	20,0	15,5	30,0	11,5	12,5	19,5
M20	21,0	22,0	17,5	33,0	12,5	13,5	21,5
M22	23,0	24,0	19,5	36,0	13,5	14,5	23,5

SVASATORI CON ELEMENTI INTERCAMBIABILI PER SEDI DI VITI CON TESTA "ALLEN" E CONICA

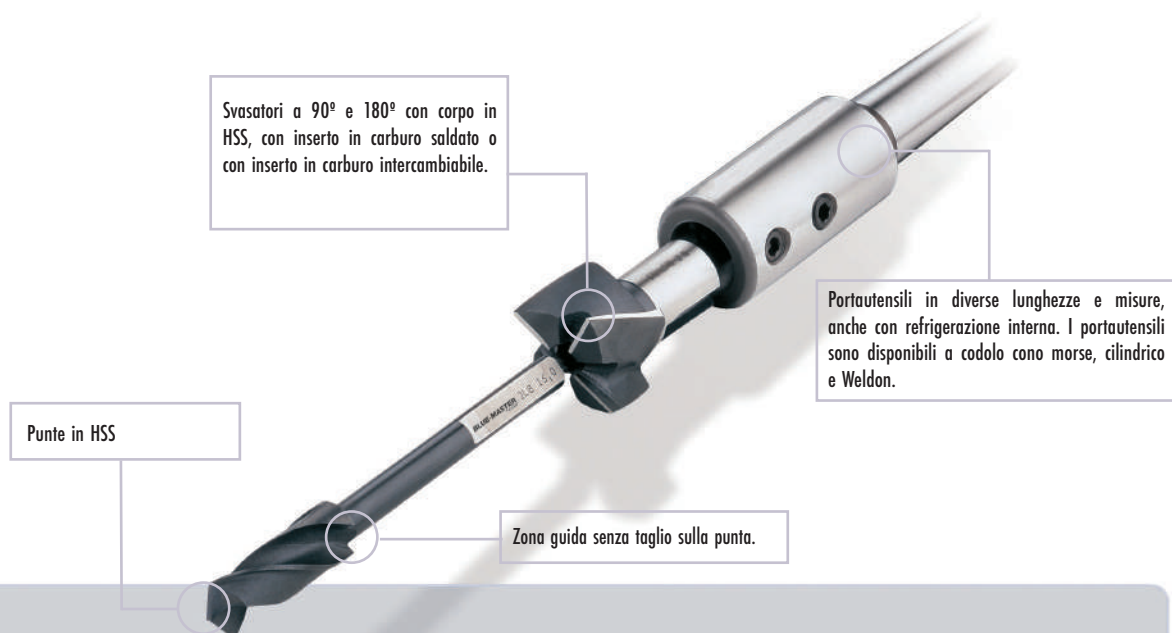

IL SISTEMA BLUEMASTER

Il sistema BLUEMASTER è unico per le operazioni di svasatura, incrementandone la produttività e diminuendone i costi.

I nostri portautensili, frese, punte e guide si possono combinare per adattarli a tutti i tipi di macchine e applicazioni.

Può comporre facilmente più di 1.500.000 utensili speciali con solo 1.300 pezzi.

Il sistema è costituito da 3 gruppi di dimensioni: **SERIE A, SERIE B e SERIE C.**

Tutte le combinazioni devono essere formate da elementi appartenenti allo stesso gruppo. Utensili di gruppi differenti non sono combinabili tra loro.

Nelle pagine seguenti troverà gli intervalli di misure disponibili per ogni gruppo e i consigli per la scelta corretta sia dell'utensile sia dei parametri di taglio.

Importante!

- * Per l'utilizzo con metallo duro, collocare la vite di regolazione assiale in contatto con la guida o la punta inserita.
- * Lasciare uno spazio tra il filo e la guida o la punta per prevenire rotture da impatto accidentale.
- * La vite assiale si usa anche per prolungare la vita delle punte prima di riaffilarle.

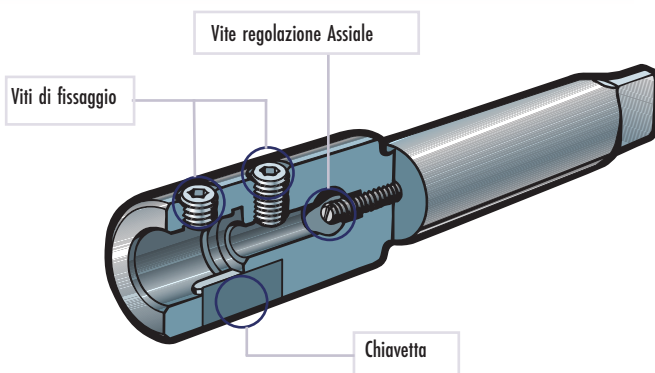

DIMENSIONI DI GUIDA, MANDRINO E PUNTA

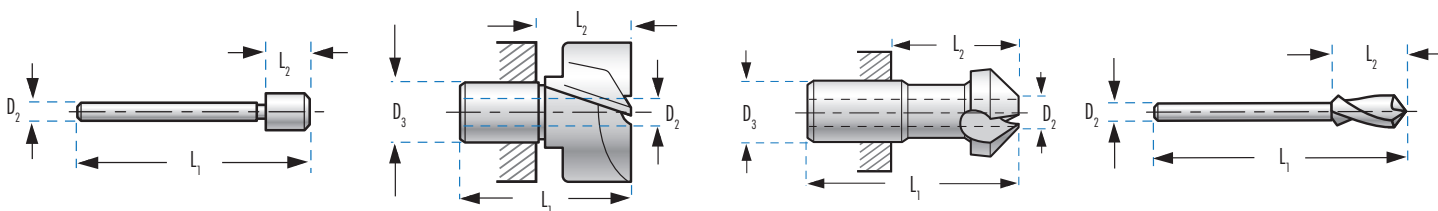

GUIDA				MANDRINO				SVASATORE				PUNTA					
	D2 mm	L1 mm	L2 mm	D3 mm	D2 mm	L1 mm	L2 mm	D3 mm	D2 mm	L1 mm	L2 mm	D2 mm	L1 mm	L2 mm			
AGP	4	64	9	APAV-MD-PQ	10	4	40	22	AVC	10	4	40	22	ABP	4	70	15
BGP	6	80	14	BPAV-MD-PQ	14	6	48	28	BVC	14	6	48	28	BBP	6	95	25
CGP	10	110	20	CPAV-MD-PQ	22	10	61	33	CVC	22	10	61	33	CBP	10	125	30

SVASATORI CON ELEMENTI INTERCAMBIABILI PER SEDI DI VITI CON TESTA "ALLEN" E CONICA

Svasatori

Rosa

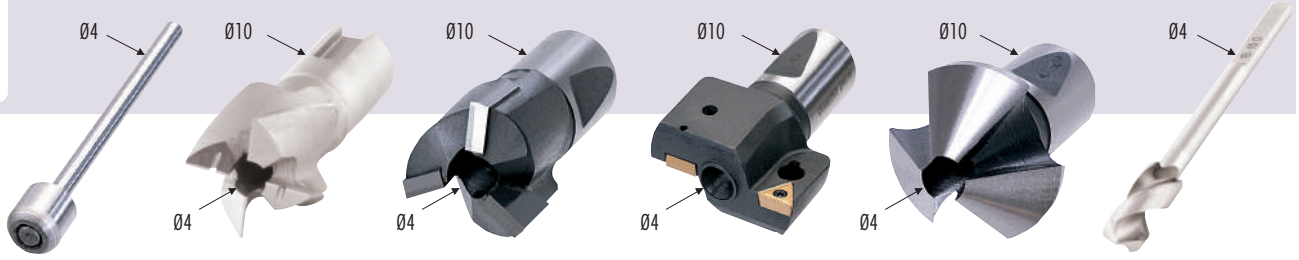
SERIE
A

GUIDA

MANDRINO

MANDRINO

PLACCHETTA INTERCAMBIABILE

SVASATORE

PUNTA

AGP

APAV

APAVMD

APAVPQ

AVC

ABP

HSS

MD

placchetta
non inclusa

PMD



HSS

HSS

€

€

€

€

€

€

AGP	APAV	APAVMD	APAVPQ	AVC	ABP
€	HSS €	MD €	placchetta non inclusa PMD €	90° HSS €	HSS €
					ABP0430 84,44
					ABP0450 84,44
					ABP0500 84,44
					ABP0530 84,44
					ABP0550 84,44
AGP0400 48,72					ABP0600 99,23
AGP0450 58,09	APAV0700 148,68			AVC0800 193,76	ABP0640 99,23
AGP0550 58,09	APAV0800 146,86				ABP0650 99,23
AGP0600 58,09	APAV0900 146,86	APAVMD1000 417,54		AVC1000 193,76	
AGP0650 58,09	APAV1000 142,18				
AGP0640 58,09					
AGP0660 58,09	APAV1100 146,86	APAVMD1100 417,54		AVC1200 196,67	ABP0660 99,23
AGP0500 58,09					ABP0700 99,23
	APAV1150 162,39				
	APAV1200 148,68	APAVMD1200 417,54		AVC1150 190,17	
	APAV1250 164,91			AVC1240 198,94	
	APAV1300 162,04	APAVMD1300 417,54			
	APAV1350 186,56			AVC1350 198,94	
	APAV1400 162,04	APAVMD1400 421,51		AVC1400 213,27	
	APAV1450 186,93				
AGP0840 58,82					
AGP0900 58,82	APAV1500 163,85	APAVMD1500 426,20		AVC1500 215,05	
AGP0680 58,09					
AGP0700 58,09	APAV1600 173,20	APAVMD1600 435,95		AVC1600 216,16	
AGP0750 58,09	APAV1700 176,49	APAVMD1700 445,33		AVC1650 210,40	
AGP0800 58,82	APAV1800 181,15	APAVMD1800 454,67	APAVPQ1800 949,79		
AGP0850 58,82	APAV1900 192,72	APAVMD1900 475,26			
AGP0900 58,82	APAV2000 199,56	APAVMD2000 485,38	APAVPQ2000 1.064,58		
AGP0950 58,82	APAV2100 217,63	APAVMD2100 508,45			
AGP1000 58,82					
AGP1050 58,82					
AGP1100 58,82					
AGP1150 58,82					

ADATTATORI



APH

	D1 mm	D2 mm	L1 mm	L2 mm	CM Ø mm	€
APHCM1	18	10	110	48	CM1	348,23
APHCM2	18	10	132	57	CM2	341,75
APH-T0	18	10	92	42	Ø10	325,49

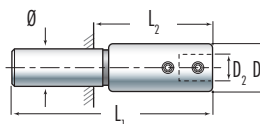
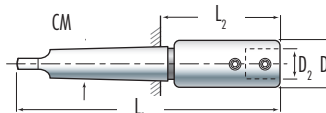

PLACCHETTE DI RICAMBIO

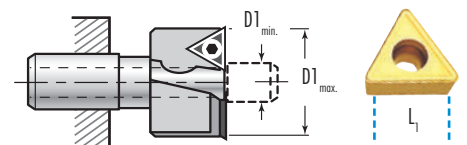

PPQ

	L1 mm	D1min. Ømm	D1max. Ømm	€
PPQ07	7	18	20	36,09

SVASATORI CON ELEMENTI INTERCAMBIABILI PER SEDI DI VITI CON TESTA "ALLEN" E CONICA

Svasatori

Rosa

SERIE B

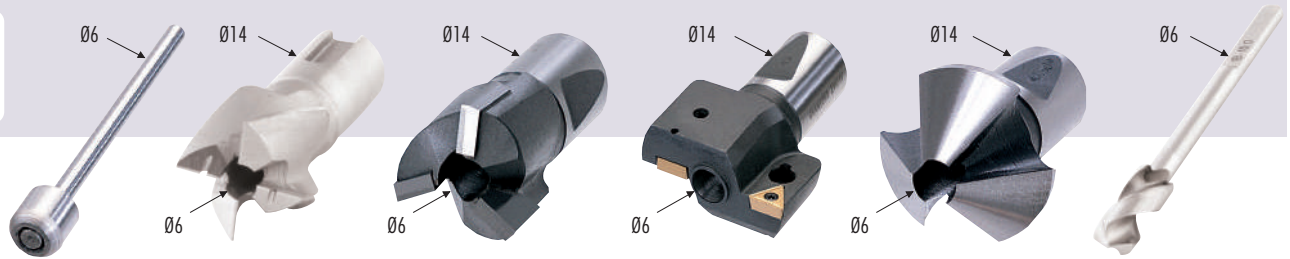

GUIDA		MANDRINO		MANDRINO		PLACCHETTA INTERCAMBIABILE		SVASATORE		PUNTA	
BGP		BPAV		BPAVMD		BPAVPQ		BVC		BBP	
€		HSS €		MD €		placchetta non inclusa	PMD €	90° HSS €		HSS €	
		BPAV1300	164,55	BPAVMD1300	445,33						
		BPAV1350	185,83								
		BPAV1400	164,55	BPAVMD1400	445,33						
		BPAV1450	185,83								BBP0800 118,01
BGP0840	54,86										
BGP0900	54,86	BPAV1500	164,55	BPAVMD1500	445,33			BVC15	204,26		BBP0900 118,01
BGP0680	54,86										
BGP0800	54,86										
BGP1000	54,86	BPAV1550	188,38								
BGP1150	58,09	BPAV1600	173,60	BPAVMD1600	461,90						BBP0840 118,01
BGP1250	60,26	BPAV1650	201,35								BBP0850 118,01
BGP1350	66,39	BPAV1700	180,78	BPAVMD1700	461,90						BBP0950 118,01
BGP1450	67,10	BPAV1750	202,79								BBP1000 134,60
		BPAV1900	208,59	BPAVMD1900	465,90						BBP1050 134,60
BGP1050	58,09										
BGP1100	58,09	BPAV1800	187,66	BPAVMD1800	465,90						
BGP0850	54,86										
BGP1300	66,39										
BGP1400	67,10	BPAV2000	208,59	BPAVMD2000	480,33	BPAVPQ2000	950,60	BVC25	240,36		
BGP1020	58,09										
BGP1500	67,10										
BGP1550	67,10	BPAV2400	246,49	BPAVMD2400	510,28	BPAVPQ2400	951,83	BVC28	279,66		
BGP1200	58,09										
BGP1700	67,10										
BGP1750	67,10	BPAV2600	263,43	BPAVMD2600	513,16	BPAVPQ2600	1.091,34	BVC30	285,83		
BGP1400	67,10										
BGP1900	68,55										
BGP2000	85,53	BPAV3000	355,81	BPAVMD3000	559,73	BPAVPQ3000	1.091,34				
		BPAV3400	420,77	BPAVMD3400	645,55	BPAVPQ3400	1.259,64				

ADATTATORI



BPH						
	D1 mm	D2 mm	L1 mm	L2 mm	CM Ømm	€
BPHCM1	24	14	123	62	CM1	386,15
BPHCM2	24	14	137	62	CM2	352,58
BPHCM3	24	14	160	66	CM3	386,15
BPH-12	24	14	120	55	Ø12	348,58

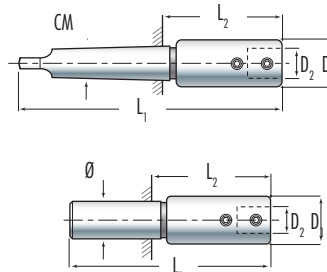

PLACCHETTE DI RICAMBIO

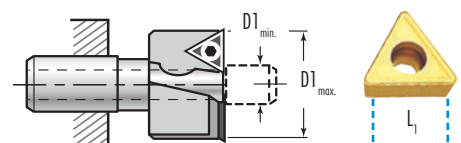

PPQ				
	L1 mm	D1 min. Ømm	D1 max. Ømm	€
PPQ07	7	20	25	36,09
PPQ10	10	26	33	32,49
PPQ12	12	34	36	32,49

SVASATORI CON ELEMENTI INTERCAMBIABILI PER SEDI DI VITI CON TESTA "ALLEN" E CONICA

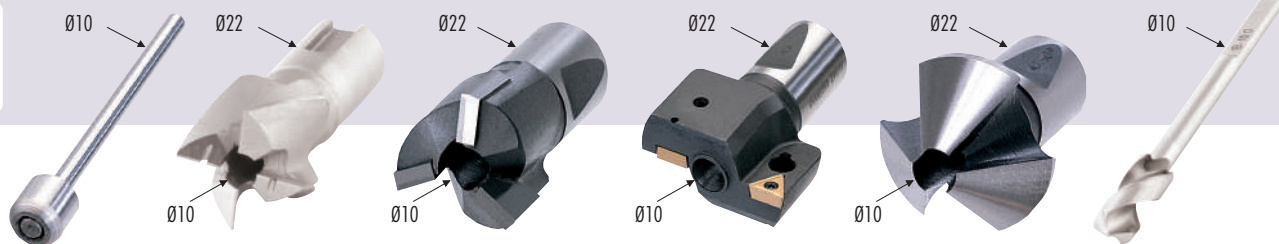
SERIE
C

GUIDA

MANDRINO

MANDRINO

PLACCHETTA INTERCAMBIABILE

SVASATORE

PUNTA

CGP

CPAV

CPAVMD

CPAVPQ

CVC

CBP

€	HSS €	MD €	placchetta non inclusa	PMD €	90° HSS €	HSS €			
CGP1200	62,42	CPAV2300	298,80	CPAVMD2300	556,82				
CGP1250	62,42	CPAV2400	302,76	CPAVMD2400	551,03				
CGP1300	62,42	CPAV2500	327,32	CPAVMD2500	552,13				
CGP1350	62,42	CPAV2600	333,81	CPAVMD2600	567,29				
CGP1400	73,27	CPAV2700	338,49						
CGP1450	73,27	CPAV2800	344,99	CPAVMD2800	572,69		CBP1700 294,84		
CGP1500	73,27	CPAV2900	353,28				CBP1800 332,36		
CGP1600	73,27	CPAV3100	383,97				CBP1900 348,58		
CGP1650	73,27	CPAV3200	396,61	CPAVMD3200	625,37		CBP2100 377,86		
CGP1700	73,27	CPAV3300	400,21				CBP2300 454,67		
CGP1900	73,27								
CGP2000	73,27	CPAV3000	357,97	CPAVMD3000	631,52	CVC35	416,79	CBP2000 377,86	
CGP1550	73,27								
CGP2100	81,58								
CGP2200	81,58	CPAV3400	404,19	CPAVMD3400	671,22	CPAVPQ3400	1.302,62	CVC37 440,99	CBP2200 421,51
CGP1750	73,27								
CGP1850	73,27	CPAV3500	423,31						
CGP2300	81,58								
CGP2400	81,58	CPAV3600	428,36	CPAVMD3600	689,61	CPAVPQ3600	1.302,62	CVC37 440,99	CBP2400 464,47
CGP1950	73,27								
CGP2500	81,58								
CGP2600	100,31	CPAV4000	497,28	CPAVMD4000	763,95	CPAVPQ4000	1.332,63	CVC40 468,77	
CGP2100	81,58								
CGP2200	81,58	CPAV4500	613,49			CPAVPQ4500	1.356,96		
CGP2050	81,58	CPAV5000	890,99			CPAVPQ5000	1.587,73		
		CPAV5500	938,62			CPAVPQ5500	1.875,26		
		CPAV6000	989,13			CPAVPQ6000	1.875,26		
		CPAV6500	1.112,58			CPAVPQ6500	2.144,53		

ADATTATORI



	D1 mm	D2 mm	L1 mm	L2 mm	CM Ømm	CPH €
CPHCM2	36	22	160	85	CM2	508,45
CPHCM3	36	22	180	87	CM3	480,33
CPHCM4	36	22	206	89	CM4	538,43
CPHCM5	36	22	240	91	CM5	1.184,75
CPH-12	36	22	140	71	Ø20	348,58

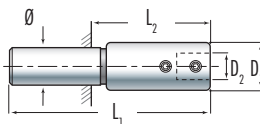
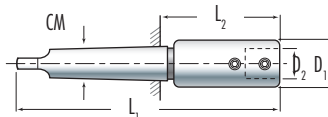

PLACCHETTE DI RICAMBIO

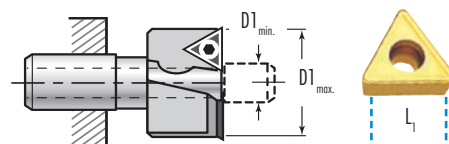

	L1 mm	D1min. Ømm	D1max. Ømm	PPQ €
PPQ12	12	34	45	32,49
PPQ17	17	<46		50,35

SET DI SVASATORI

SET DI PUNTE A SVASARE PER TUBI E LAMIERE HSS E HSSCo

Svasatori

Rosa



Ref. PAV6CM2



Ref. PAV40BM2313

Metallo "Classico"

- Scatola metallica alta resistenza

M





Ref. AV40BM234

Ref. AV6CM3

Plástica Blu

- Rigido, robusto e leggero
- Finestra trasparente
- Plastica rinforzata con gomma antiurto

P I riferimenti che iniziano con "P" vengono forniti in custodia plastica.

AV40	Ref.	Unità	CONTENUTO	HSS	TiN	
				€		
	PAV40BM234	3	P AV40BM2 (4-12 mm) AV40BM3 (4-20 mm) AV40BM4 (4-30 mm)	136,87	205,94	
	PAV40BM235	3	P AV40BM2 (4-12 mm) AV40BM3 (4-20 mm) AV40BM5 (6-38 mm)	230,42	333,47	
	PAV40BM2313	3	P AV40BM2 (4-12 mm) AV40BM3 (4-20 mm) AV40BM13 (6-40 mm)	273,80	394,61	
	AV40BM234	3	M AV40BM2 (4-12 mm) AV40BM3 (4-20 mm) AV40BM4 (4-30 mm)	136,87	205,94	
	AV40BM22122	3	M AV40BM2 (4-12 mm) AV40BM21 (7+10-20mm) AV40BM22 (10+20-30mm)	179,14	280,22	
AVC40				HSSCo	TiN	
HSSCo	AVC40BM234	3	M AVC40BM2 (4-12 mm) AVC40BM3 (4-20 mm) AVC40BM4 (4-30 mm)	181,26	294,99	
AV42				HSSCo	TiN	
HSSCo	AV42BM234	3	M AV42BM2 (4-12 mm) AV42BM3 (4-20 mm) AV42BM4 (4-30 mm)	173,99	252,21	
AV30				HSS	TiN	
	HSS	AV30BM012	3	M AV30BM0 (3-14 mm) AV30BM1 (6-20 mm) AV30BM2 (16-30 mm)	99,60	189,05
AVC30				HSSCo	TiN	
	HSSCo	AVC30BM012	3	M AVC30BM0 (3-14 mm) AVC30BM1 (6-20 mm) AVC30BM2 (16-30 mm)	144,87	204,07



AV40BM2 AV40BM3 AV40BM4 AV40BM5 AV40BM13

AVC40BM2 AVC40BM3 AVC40BM4



AV42BM2 AV42BM3 AV42BM4



AV30BM0 AV30BM1 AV30BM2

AVC30BM0 AVC30BM1 AVC30BM2

SET DI SVASATORI



AV16	Ref.	Unità	CONTENUTO	€
HSS	AV16CM1	6 M	Ø 6 - 8 - 10 11,5 - 15 - 19 mm	158,29
	AV16CM2	6 M	Ø 6,3 - 8,3 - 10,4 12,4 - 16,5 - 20,5 mm	132,31
TiN	AV16CM3	7 M	Ø 6,3 - 8,3 - 10,4 12,4 - 16,5 - 20,5 - 25 mm	182,69



Ref. PAV6CM2

Ref. AV16CM3



AV6	Ref.	Unità	CONTENUTO	€
HSS	AV6CM1	6 M	Ø 6 - 8 - 10 11,5 - 15 - 19 mm	103,34
	AV6CM2	6 M	Ø 6,3 - 8,3 - 10,4 12,4 - 16,5 - 20,5 mm	105,85
	AV6CM3	7 M	Ø 6,3 - 8,3 - 10,4 12,4 - 16,5 - 20,5 - 25 mm	144,53
	PAV6CM2	6 P	Ø 6,3 - 8,3 - 10,4 12,4 - 16,5 - 20,5 mm	105,85



AV7	Ref.	Unità	CONTENUTO	€
HSSCo	AV7CM1	6 M	Ø 6 - 8 - 10 11,5 - 15 - 19 mm	173,87
	AV7CM2	6 M	Ø 6,3 - 8,3 - 10,4 12,4 - 16,5 - 20,5 mm	169,57
	AV7CM3	7 M	Ø 6,3 - 8,3 - 10,4 12,4 - 16,5 - 20,5 - 25 mm	234,54
	PAV7CM2	6 P	Ø 6,3 - 8,3 - 10,4 12,4 - 16,5 - 20,5 mm	169,57

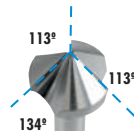

AV66	Ref.	Unità	CONTENUTO	€
HSSCo	PAV66CM2	6 P	Ø 6,3 - 8,3 - 10,4 12,4 - 16,5 - 20,5 mm	206,04



AV67	Ref.	Unità	CONTENUTO	€
HSSCo	PAV67CM2	6 P	Ø 6,3 - 8,3 - 10,4 12,4 - 16,5 - 20,5 mm	267,86



AV55	Ref.	Unità	CONTENUTO	€
HSSCo	PAV55CM2	6 P	Ø 6,3 - 8,3 - 10,4 12,4 - 16,5 - 20,5 mm	267,86



AV6MD	Ref.	Unità	CONTENUTO	€
MD	PAV6MDCM2	6 P	Ø 6,3 - 8,3 - 10,4 12,4 - 16,5 - 20,5 mm	586,17

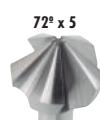

AV55MD	Ref.	Unità	CONTENUTO	€
MD	PAV55MDCM2	6 P	Ø 6,3 - 8,3 - 10,4 12,4 - 16,5 - 20,5 mm	818,08

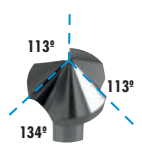

AV66MD	Ref.	Unità	CONTENUTO	€
MD	PAV66MDCM2	6 P	Ø 6,3 - 8,3 - 10,4 12,4 - 16,5 - 20,5 mm	654,47

SET DI SVASATORI

DIN 334C

AV8	Ref.	Unità	CONTENUTO	€
	AV8CM2	6 M	Ø 6,3 - 8 - 10 12,5 - 16 - 20 mm	166,97
HSS	AV8CM3	7 M	Ø 6,3 - 8,0 - 10 12,5 - 16 - 20 - 25 mm	221,90

NORMA CELESA

AV9	Ref.	Unità	CONTENUTO	€
	AV9CM1	6 M	Ø 6,3 - 8,3 - 10,4 12,4 - 16,5 - 20,5 mm	177,87
HSS	AV9CM5	7 M	Ø 6,3 - 8,3 - 10,4 12,4 - 16,5 - 20,5 - 25 mm	243,24

* Altri set su richiesta AV99, ecc.

90°

AV1	Ref.	Unità	CONTENUTO	€
HSS	AV1S2	5 M	Ø 10 - 14 20 - 27 - 30 mm	233,61

*Fino ad esaurimento scorte

HSS DIN 373

AV2M	Ref.	Unità	CONTENUTO	€
FINE	AV2M3-10	6 M	M3-M4-M5-M6-M8-M10	177,47
	AV2M3-12	7 M	M3-M4-M5-M6-M8-M10-M12	225,39

AV2MM	Ref.	Unità	CONTENUTO	€
MEDIA	AV2M3-10M	6 M	M3-M4-M5-M6-M8-M10	187,43
	AV2M3-12M	7 M	M3-M4-M5-M6-M8-M10-M12	238,03

AV2GM	Ref.	Unità	CONTENUTO	€
FORO FILETTATO	AV2M3-10G	6 M	M3-M4-M5-M6-M8-M10	187,43
	AV2M3-12G	7 M	M3-M4-M5-M6-M8-M10-M12	238,03



NORMA CELESA

AV10	Ref.	Unità	CONTENUTO	€
	AV10CM1	6 M	Ø 6,3 - 8,3 - 10,4 12,4 - 16,5 - 20,5 mm	195,64
HSS	AV10CM6	7 M	Ø 6,3 - 8,3 - 10,4 12,4 - 16,5 - 20,5 - 25 mm	268,24



AV1



AV2 AV2MM AV2GM

Ref. AV2M3-10

UTENSILI A SBAVARE DI PRECISIONE

GLI UTENSILI A SBAVARE BLUEMASTER

Gli utensili a sbavare BLUEMASTER si utilizzano per rimuovere i trucioli dai bordi e gli spigoli di pezzi fabbricati in metallo, plastica o legno.

Il sistema si completa unendo i tre componenti segnalati: LAMA + PORTALAME + CODOLO UNIVERSALE

Il codolo può essere utilizzato con tutti i gruppi di lame, sostituendo opportunamente il portalame per ognuno di essi.

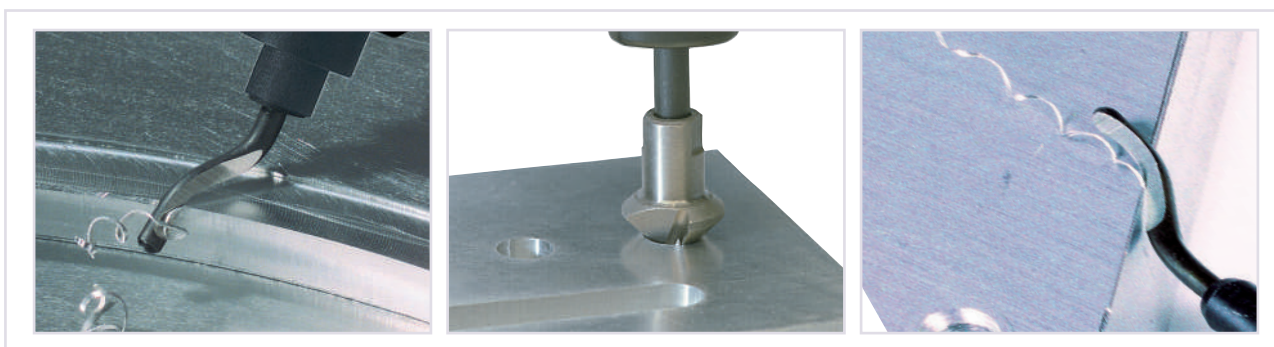
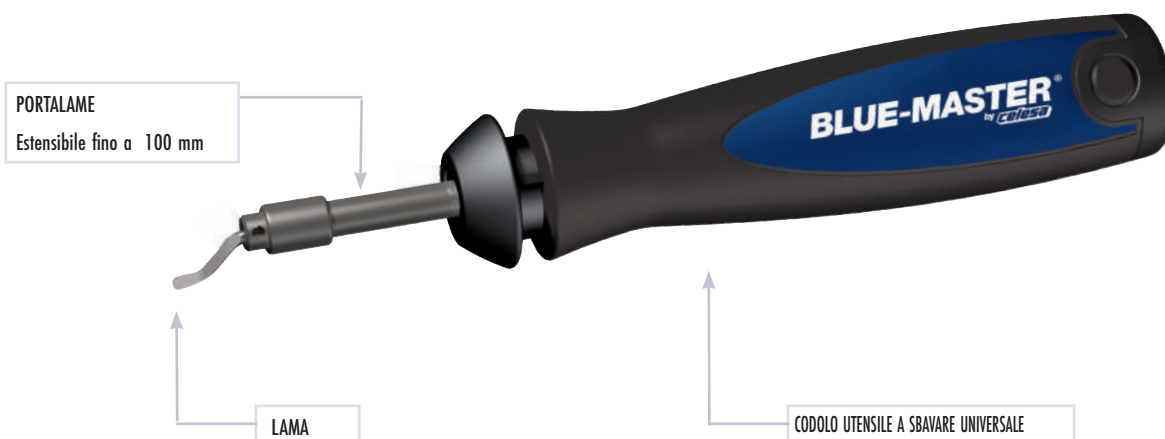

INSIEME B

JRB1

CONTENUTO B:

Ref. RB10



Ref. RBB1



Ref. RB20



Ref. RBB



Blister: 35,13 €

INSIEME C

JRB2

CONTENUTO C:

Ref. RC42

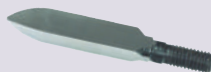

Ref. RBB1



Ref. RBC



Blister: 63,97 €

INSIEME D

JRB3

CONTENUTO D:

Ref. RD80MD



Ref. RBB1



Ref. RBD



Blister: 100,83 €

INSIEME E

JRB4

CONTENUTO E:

Ref. RE10



Ref. RBB1



Ref. RE20



Ref. RBE



Ref. RE30

Blister: 39,12 €



UTENSILI A SBAVARE DI PRECISIONE

GRUPPO B

PORTALAME GRUPPO B

Ø2,6mm



Per lame a sbavare Gruppo B

RBB

12,34 €

LAME GRUPPO B



Lama a sbavare
Serie corta: acciaio, alluminio, plastica

RB10*

Blister 10 U.: **2,16 €/U.**



Lama punzonatrice in metallo duro

RB50*

Blister 1 U.: **38,66 €**



Lama a sbavare bidirezionale
Serie corta:ottone, ghisa

RB20

Blister 10 U.: **2,16 €/U.**



Lama a sbavare per la parte posteriore di un trapano fino a 20 mm de profondità

RB60*

Blister 10 U.: **4,49 €/Ud**



Lama a sbavare per la parte posteriore di un trapano fino a 20 mm de profondità

RB30

Blister 10 U.: **2,16 €/U.**



Lama a sbavare con spigoli esterni

RB70MD*

Blister 1 U.: **46,16 €**

*Fino ad esaurimento scorte

GRUPPO C

PORTALAME GRUPPO C



Per lame a sbavare Gruppo C

RBC

Blister 1 U.: **12,34 €**

LAME GRUPPO C



Lama raschiatrice larghezza 4 x 20 mm

RC40*

Blister 1 U.: **25,14 €**

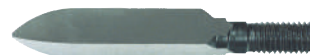

Lama raschiatrice larghezza 8 x 30 mm

RC42*

Blister 1 U.: **31,27 €**

*Fino ad esaurimento scorte

GRUPPO D

PORTALAME GRUPPO D



Per lame a sbavare Gruppo D

RBD

Blister 1 U.: **12,34 €**

LAME GRUPPO D



Lama a sbavare in metallo duro a "V" femmina bordi fino a 3 mm

RD80MD*

Blister 1 U.: **65,69 €**



Lama a sbavare in metallo duro a "V" femmima bordi fino a 8 mm

RD82MD*

Blister 1 U.: **103,01 €**

*Fino ad esaurimento scorte

CODOLO UTENSILE A SBAVARE UNIVERSALE

Usi generali
Adatto per portalamme:
Ref. RBB / RBC / RBD / RBE / RBF

**RBB1**Blister 1 ud.: **16,19 €**

UTENSILI A SBAVARE DI PRECISIONE

**GRUPPO
E**

PORTALAME GRUPPO E



Ø3,2mm

Portalamme gruppo E

RBEBlister 1 ud.: **12,34 €**

LAME GRUPPO E



Lama a sbavare per interni ed esterni
Serie lunga: acciaio, alluminio, plastica

RE10Blister 10 ud.: **2,66 €/Ud**

Lama a sbavare per bordi retti: scanalatura di
chiavetta,...

RE35Blister 10 ud.: **2,83 €/Ud**

Lama a sbavare bidirezionale
Serie lunga: ottone, ghisa

RE20Blister 10 ud.: **2,66 €/Ud**

Lama a sbavare chiusa doppio spigolo per fori
di 4 mm di profondità

RE30Blister 10 ud.: **2,66 €/Ud**

Lama a sbavare per la parte posteriore di un
trapano fino a 20 mm di profondità

RE60*Blister 5 ud.: **3,73 €/Ud**

*Fino ad esaurimento scorte

**GRUPPO
F**

PORTALAME GRUPPO F



Per lame a sbavare Gruppo F

RBFBlister 1 ud.: **12,34 €**

LAME GRUPPO F (Filettatura M05 x 0.80)

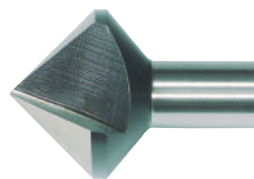

Lama a svasare HSS Ø 12 mm

RF12Blister 1 ud.: **27,73 €**

Lama a svasare HSS Ø 30 mm

RF30Blister 1 ud.: **92,67 €**

Lama a svasare HSS Ø 20 mm

RF20Blister 1 ud.: **53,61 €**