



BLUE-MASTER[®]
by *CE/ESA*



ESCAREADORES

BROCAS ESCALONADAS DE CANAIS RETOS HSS

HSS



Ref. AV40

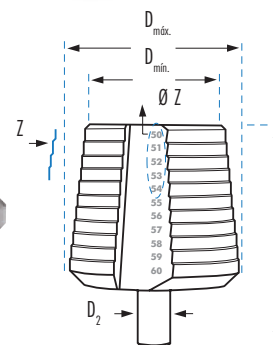
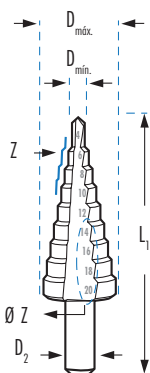

BM1

BM2

BM3

BM4

BM5

Ref. AV40BM25 / 26 / 27 / 28 / 29

AV40

	D min. mm	D max. mm	D2 mm	L1 mm	Z	Ø Z mm menor-maior	AV40	
							HSS €	TiN €
AV40BM1B	4,0	12,0	6,0	65	5	4-6-8-10-12	40,72	64,25
AV40BM2B	4,0	12,0	6,0	65	9	4-5-6-7-8-9-10-11-12	41,77	64,62
AV40BM3B	4,0	20,0	8,0	69	9	4-6-8-10-12-14-16-18-20	53,55	82,48
AV40BM4B	4,0	30,0	10,0	96	14	4-6-8-10-12-14-16-18-20-22-24-26-28-30	87,84	133,90
AV40BM14	4,0	39,0	10,0	107	13	4-6-9-12-15-18-21-24-27-30-33-36-39	217,94	336,55
AV40BM16B	5,0	28,0	10,0	69	7	5-8-8-11,8-15,3-19-24,5-28	101,09	159,09
AV40BM35B	5,0	35,0	13,0	80	13	5-7-10-12-15-17-20-22-25-27-30-32-35	130,87	190,28
AV40BM11B	6,0	25,0	10,0	65	7	6-9-12-16-20-22,50-25	82,55	111,11
AV40BM10B	6,0	26,7	10,0	75	8	6-9-11,40-14-17,25-19-21,25-26,75	160,73	252,93
AV40BM17B	6,0	30,5	10,0	80	9	6-9-12,5-15,2-18,6-20,4-22,5-28,3-30,5	170,65	268,53
AV40BM12B	6,0	32,0	10,0	75	9	6-9-12-16-20-22,5-25-28,5-32	116,51	140,22
AV40BM18B	6,0	37,0	10,0	100	12	6-9-12,5-15,2-18,6-20,4-22,5-26-28,3-30,5-34-37	189,65	293,96
AV40BM5B	6,0	38,0	10,0	96	12	6-9-13-16-19-21-23-26-29-32-35-38	204,62	271,25
AV40BM13	6,0	40,0	13,0	105	16	6-11-17-23-29-30-31-32-33-34-35-36-37-38-39-40	282,17	319,36
AV40BM15B	6,5	32,5	10,0	79	9	6,50-8,50-10,50-12,50-16,50-20,50-25,50-29-32,50	134,90	189,06
AV40BM20	6,5	40,5	10,0	96	11	6,50-8,50-10,50-12,50-16,50-20,50-25,50-29	211,49	332,81
AV40BM21B	7,0	20,0	10,0	80	12	32,50-36,50-40,50	84,62	133,16
AV40BM22B	10,0	30,0	13,0	83	12	7-10-11-12-13-14-15-16-17-18-19-20	132,46	207,81
AV40BM25B	12,0	20,0	8,0	66	9	10-20-21-22-23-24-25-26-27-28-29-30	78,46	105,01
AV40BM26B	20,0	30,0	10,0	78	11	12-13-14-15-16-17-18-19-20	114,45	161,23
AV40BM27	30,0	40,0	10,0	78	11	20-21-22-23-24-25-26-27-28-29-30	171,42	220,70
AV40BM28	40,0	50,0	13,0	85	11	30-31-32-33-34-35-36-37-38-39-40	245,06	341,55
AV40BM29	50,0	60,0	13,0	85	11	40-41-42-43-44-45-46-47-48-49-50	308,77	383,55
AV40BM29	50,0	60,0	13,0	85	11	50-51-52-53-54-55-56-57-58-59-60		

PARA TUBULAÇÕES ROSCA GAS

AV40BM6B	6,0	32,0	10,0	75	8	6-9-11,20(1/8)-14,50(1/4)-18,20(3/8)-22,30(1/2)-27,90(3/4)-32	120,88	165,71
----------	-----	------	------	----	---	---	--------	--------

PARA REBITES CEGOS M3 - M4 - M5 - M6 E M7

AV40BM7B	4,8	10,6	6,0	54	5	4,80-6,40-7,20-9,60-10,65	39,39	56,20
----------	-----	------	-----	----	---	---------------------------	-------	-------

PARA CONDUÇÕES ELÉTRICAS (ANTIGA E NOVA NORMA)

AV40PG21B	PG7	PG21	13,0	70	11	6,5-8,5-10,5-12,5(PG7)-15,2(PG9)-18,6(PG11) 20,4(PG13,5)-22,5(PG16)-25,5-18,3(PG21)-30,5	133,11	188,18
AV40PG29B	PG7	PG29	13,0	81	14	6,5-9-11-12,5(PG7)-15,2(PG9)-18,6(PG11)-20,4(PG13,5) 22,5(PG16)-26-28,3(PG21)-30,5-33-35-37(PG29)	171,96	241,23
AV40BM8B	8,5	32,5	10,0	70	12	8,5-10,5-12,5-14,5-16,5-18,5-20,5-23,5-25,5 28-30,5-32,5	100,91	146,22
AV40BM9B	8,5	40,5	12,0	84	16	8,5-10,5-12,5-14,5-16,5-18,5-20,5-23,5-25,5 28-30,5-32,5-34,5-36,5-38,5-40,5	143,69	216,55

BROCAS ESCALONADAS DE CANAIS RETOS HSSCO

HSSCo **INOX** Ref. AVC40

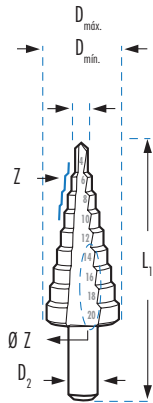

Escareadores

Rosa

	D mín. mm	D máx. mm	D2 mm	L1 mm	Z	Ø Z mm menor-maior	AVC40	
							HSSCo €	TiN €
AVC40BM1B	4,0	12,0	6,0	65	5	4-6-8-10-12	50,08	76,78
AVC40BM2B	4,0	12,0	6,0	65	9	4-5-6-7-8-9-10-11-12	52,88	92,74
AVC40BM3B	4,0	20,0	8,0	69	9	4-6-8-10-12-14-16-18-20	64,94	105,07
AVC40BM4B	4,0	30,0	10,0	96	14	4-6-8-10-12-14-16-18-20-22-24-26-28-30	100,59	164,70
AVC40BM18B	6,0	37,0	10,0	100	12	6-9-12,5-15,2-18,6-20,4-22,5-26-28,3-30,5-34-37	205,94	309,27

BROCAS ESCALONADAS DE CANAIS RETOS HSS SDS-PLUS

NEW **HSS** **SDS Plus**

Ref. AV40BMSDS

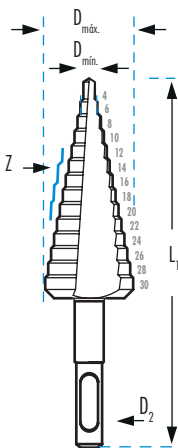

BMSDS1 BMSDS2 BMSDS3 BMSDS4

	D mín. mm	D máx. mm	D2 mm	L1 mm	Z	Ø Z mm menor-maior	AV40BMSDS	
							HSS €	TiN €
AV40BMSDS1B	4,0	12,0	8,8	95,5	5	4-6-8-10-12	43,16	68,11
AV40BMSDS2B	4,0	12,0	8,8	95,5	9	4-5-6-7-8-9-10-11-12	44,27	68,50
AV40BMSDS3B	4,0	20,0	8,8	104,0	9	4-6-8-10-12-14-16-18-20	56,76	87,43
AV40BMSDS4B	4,0	30,0	8,8	126,0	14	4-6-8-10-12-14-16-18-20-22-24-26-28-30	93,11	141,93

BROCAS ESCALONADAS DE CANAIS HELICOIDAIS HSS

HSS

Ref. AV42



BM2

BM3

BM4

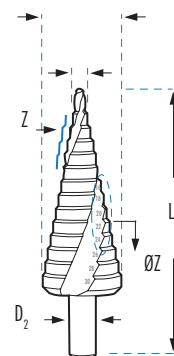

AV42

	D mín. mm	D máx. mm	D2 mm	L1 mm	Z	Ø Z mm menor-maior	HSS	TiN
							€	€
AV42BM1B	4,0	12,0	6,0	65	5	4-6-8-10-12	45,71	65,46
AV42BM2B	4,0	12,0	6,0	68	9	4-5-6-7-8-9-10-11-12	46,17	68,17
AV42BM3B	4,0	20,0	8,0	69	9	4-6-8-10-12-14-16-18-20	61,59	95,30
AV42BM4B	4,0	30,0	10,0	96	14	4-6-8-10-12-14-16-18-20-22-24-26-28-30	101,51	151,72
AV42BM5B	6,0	38,0	10,0	96	12	6-9-13-16-19-21-23-26-29-32-35-38	218,71	285,25
AV42BM11B	6,0	25,0	10,0	65	7	6-9-12-16-20-22,50-25	85,98	119,36
AV42BM12B	6,0	32,0	10,0	75	9	6-9-12-16-20-22,5-25-28,5-32	124,60	159,36
AV42BM13	6,0	40,0	13,0	105	16	6-11-17-23-29-30-31-32-33-34-35-36-37-38-39-40	288,78	326,36
AV42BM8B	8,5	32,5	10,0	70	12	8,5-10,5-12,5-14,5-16,5-18,5-20,5-23,5 25,5-28-30,5-32,5	113,18	155,25
AV42BM9B	8,5	40,5	12,0	84	16	8,5-10,5-12,5-14,5-16,5-18,5-20,5-23,5 25,5-28-30,5-32,5-34,5-36,5-38,5-40,5	177,98	231,55

BROCAS ESCALONADAS DE CANAIS HELICOIDAIS HSS MEGAESCALONADA

NEW

HSS

Ref. AV42BM7



AV42BM702B AV42BM703B AV42BM704B

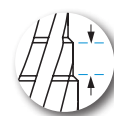

ESCALON 10 mm

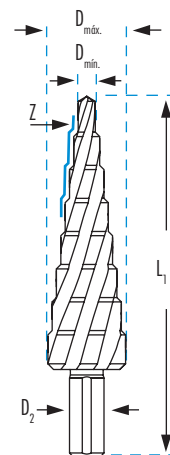
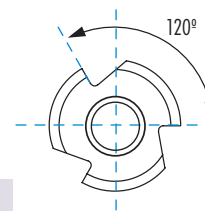

AV42

	D mín. mm	D máx. mm	D2 mm	L1 mm	Z	Ø Z mm menor-maior	HSS	TiN
							€	€
AV42BM702B	6,0	12,0	6,0	105	7	6-7-8-9-10-11-12	45,95	51,05
AV42BM703B	6,0	20,0	10,0	120	8	6-8-10-12-14-16-18-20	72,11	80,12
AV42BM704B	6,0	27,0	12,0	125	8	6-9-12-15-18-21-24-27	94,88	105,42

BROCAS ESCALONADAS HSS



Escareadores

Rosa

STEP CUT

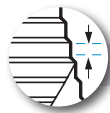
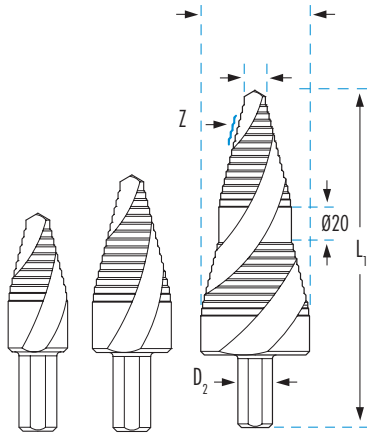

ESCALON 2 mm



AV40BM37



AV40BM38



AV40BM36

	D mín. mm	D máx. mm	D ₂ mm	L ₁ mm	Z	Ø Z mm menor-maior	AV40BM	
							HSS	TiN
							€	€
AV40BM37B	6,0	15,0	9,5	55	11	6-7-8-9-10-11-12-13-14-14,5-15	27,75	36,42
AV40BM38B	6,0	20,0	9,5	65	16	6-7-8-9-10-11-12-13-14-15-16-17-18-19-19,5-20	41,49	57,02
AV40BM36B	6,0	30,0	9,5	93	27	6-7-8-9-10-11-12-13-14-15-16-17-18-19-19,5-20-21-22-23-24-25-26-27-28-29-29,5-30	102,31	147,33

CABO SEXTAVADO 1/4"

	D mín. mm	D máx. mm	Hexagon	L ₁ mm	Z	Ø Z mm menor-maior	AV41	
							HSS	TiN
							€	€
AV41BM2B	4,0	12,0	1/4"	72	9	4-5-6-7-8-9-10-11-12	46,17	68,17
AV41BM3B	4,0	20,0	1/4"	81	9	4-6-8-10-12-14-16-18-20	61,59	95,30
AV41BM4B	4,0	30,0	1/4"	105	14	4-6-8-10-12-14-16-18-20-22-24-26-28-30	101,51	151,72



Ref. AV41BM2B

SERIE CURTA Máximo 2 mm de espessura

	D mín. mm	D máx. mm	D ₂ mm	L ₁ mm	Z	Ø Z mm menor-maior	AV41C	
							HSS	TiN
							€	€
AV41CBM2B	4,0	12,0	6,0	48	9	4-5-6-7-8-9-10-11-12	50,94	68,37
AV41CBM3B	4,0	20,0	8,0	58	9	4-6-8-10-12-14-16-18-20	63,24	88,36
AV41CBM4B	4,0	30,0	10,0	72	14	4-6-8-10-12-14-16-18-20-22-24-26-28-30	103,10	158,74



Ref. AV41CBM3B

BROCAS ESCALONADAS PARA CHAPA HSS CARACTERÍSTICAS ESPECIAIS

HSS

Escareadores

Rosa

APARAFUSAMENTOS MÉTRICOS DE CABO

	DIN	D mín. mm	D máx. mm	D2 mm	L1 mm	Z	Ø Z mm menor-maior	AV45	
								HSS €	TiN €
AV45BM0B	60423	5,3	30,5	10,0	79	9	5,3-7-9-10,5-14,5-18,5-23,5-27-30,5	180,94	233,33
AV45BM2B	60423	5,3	38,5	10,0	96	11	5,3-7-9-10,5-14,5-18,5-23,5-27-30,5-34,5-38,5	217,59	274,91



Ref. AV45BM2B

ESCALONADA RETA COM 3 CANAIS

	D mín. mm	D máx. mm	D2 mm	L1 mm	Z	Ø Z mm menor-maior	AV43	
							HSS €	TiN €
AV43BM1B	4,0	12,0	6,0	65	9	4-5-6-7-8-9-10-11-12	47,58	75,36
AV43BM2B	4,0	20,0	8,0	75	9	4-6-8-10-12-14-16-18-20	65,23	101,07
AV43BM3B	4,0	30,0	10,0	100	14	4-6-8-10-12-14-16-18-20-22-24-26-28-30	100,54	164,44



Ref. AV43BM3B

BROCA ESCALONADA COM BROCA GUIA INTERCAMBIÁVEL

	D mín. mm	D máx. mm	D2 mm	L1 mm	Z	Ø Z mm menor-maior	AV4	
							HSS €	
AV4BM3040	30,0	40,0	13,0	76	11	30-31-32-33-34-35-36-37-38-39-40	165,83	
AV4BM4050	40,0	50,0	13,0	76	11	40-41-42-43-44-45-46-47-48-49-50	239,52	
AV4BM5060	50,0	60,0	13,0	76	11	50-51-52-53-54-55-56-57-58-59-60	304,05	



Ref. AV4BM3040

BROCA GUIA



	DESCRIÇÃO	BAV4BM €
BAV4BM	10X35mm	10,73

BROCAS-ESCREADORAS E ESCALONADAS PARA TUBO, CHAPA HSS E HSSCO

HSS

HSSCo

Ref. AV30
Ref. AVC30

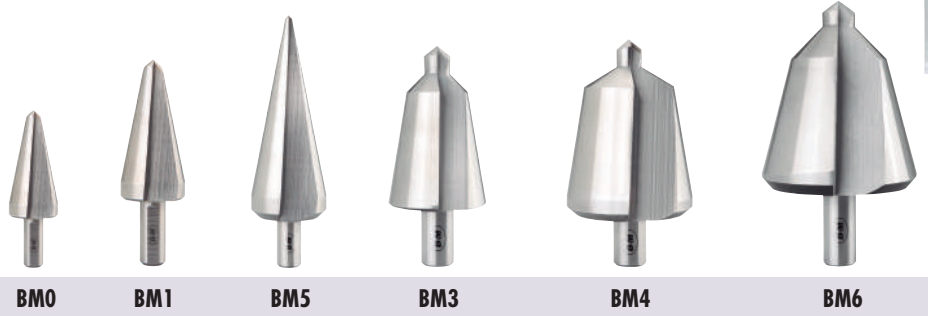

D mín. mm	D máx. mm	D2 mm	L1 mm		AV30		AVC30		
					HSS	TiN	HSSCo	TiN	
					€	€	€	€	
3,0	14,0	6,0	58	AV30BM0B	20,13	40,23	AVC30BM0B	37,26	48,67
3,0	22,5	8,0	85	AV30BM8B	55,65	100,85			
3,0	31,0	10,0	102	AV30BM5B	88,99	133,36			
5,0	25,4	10,0	87	AV30BM9B	63,28	120,89			
6,0	20,0	8,0	63	AV30BM1B	28,40	58,71	AVC30BM1B	49,40	75,03
16,0	30,0	10,0	79	AV30BM2B	54,93	97,15	AVC30BM2B	81,51	108,68
26,0	40,0	13,0	86	AV30BM3B	113,65	177,97	AVC30BM3B	164,73	228,88
36,0	50,0	13,0	89	AV30BM4	167,40	258,22			
40,0	61,0	13,0	98	AV30BM6	277,32	431,87			

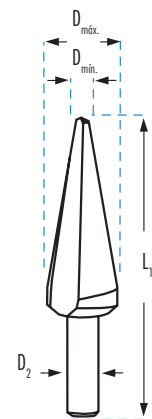

* As referências terminadas em B, fornecem-se em blister.

BROCAS-ESCREADORAS PARA CHAPA HSS CARACTERÍSTICAS ESPECIAIS

HSS

Ref. AG Broca escreadora para cortar tubos e chapas de aço, ligas leves e materiais plásticos. Indicado até 5 mm de profundidade.

HSS

Ref. AV31

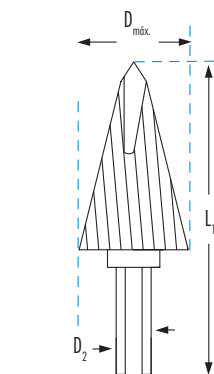

FRESA PARA TUBO E CHAPA

	D máx. mm	D2 mm	L1 mm	Nº dentes	AG
					HSS
					€
AG2500	25,0	8,0	72	20	28,42
AG3200	32,0	10,0	81	30	42,67
AG4500	45,0	10,0	94	36	70,48

TOPE DE PROFUNDIDADE

	D mín. mm	D máx. mm	D2 mm	L1 mm	AV31	
					HSS	TiN
					€	€
AV31BMOB	3,0	7,8	6,0	48	32,26	48,82
AV31BM1B	3,0	10,2	6,0	52	42,36	66,41
AV31BM2B	3,0	11,8	6,0	56	47,14	83,31

ESCAREADORES DE 3 CANAIS

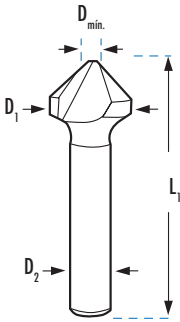

DIN 335C



3Z

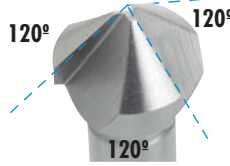

MATERIAL				HSS		HSS		HSS		HSSCo		HSSCo		HSS		
ACABAMENTO				UTILIZAÇÃO GERAL		TiN		TiAlN		UTIL. GERAL INOX		TiAlSiN		INOX Plus		
APLICAÇÃO				UTILIZAÇÃO GERAL		UTILIZAÇÃO GERAL		UTILIZAÇÃO GERAL		UTIL. GERAL INOX		UTIL. GERAL INOX		UTIL. GERAL INOX		
D1 mm-"	D mín. mm	D2 mm	L1 mm	AV6	€	AV16	€	AV37	€	AV7	€	AV38	€	L1 mm	AV15	€
4,00	1,3	4,0	40	AV60400	17,94											
4,30	1,3	4,0	40	AV60430	18,06	AV160430	25,90	AV370430	30,50	AV70430	20,09	AV380430	30,27			
5,00	1,5	4,0	40	AV60500	18,06	AV160500	25,90	AV370500	30,50	AV70500	20,09	AV380500	30,27			
5,30	1,5	4,0	40	AV60530	18,06	AV160530	25,90	AV370530	30,50	AV70530	20,09	AV380530	30,27			
5,80	1,5	5,0	45	AV60580	13,71	AV160580	22,76	AV370580	28,62	AV70580	16,35	AV380580	25,69			
5,80	1,5	6,0	45	AV60580-6	14,96											
6,00	1,5	5,0	45	AV60600	13,07	AV160600	22,26	AV370600	28,62	AV70600	15,71	AV380600	25,37			
6,00	1,5	6,0	45	AV60600-6	14,78											
6,30	1,5	5,0	45	AV60630	12,83	AV160630	22,26	AV370630	28,62	AV70630	15,42	AV380630	25,23			
6,30	1,5	6,0	45	AV60630-6	14,44											
1/4"	1,5	6,0	45	AV6P1/4	12,83											
7,00	1,8	6,0	50	AV60700	18,06	AV160700	29,72	AV370700	38,18	AV70700	20,09	AV380700	34,12			
7,30	1,8	6,0	50	AV60730	18,06	AV160730	29,72	AV370730	38,18	AV70730	20,09	AV380730	34,12			
5/16"	2,0	6,0	50	AV6P5/16	18,06											
8,00	2,0	6,0	50	AV60800	18,06	AV160800	29,72	AV370800	38,18	AV70800	20,30	AV380800	34,22			
8,30	2,0	6,0	50	AV60830	17,79	AV160830	29,72	AV370830	38,18	AV70830	19,93	AV380830	35,11			
9,00	2,2	6,0	50	AV60900	19,53											
9,40	2,2	6,0	50	AV60940	21,05	AV160940	33,54	AV370940	42,78	AV70940	23,49	AV380940	39,96			
3/8"	2,5	6,0	50	AV6P3/8	21,05											
10,00	2,5	6,0	50	AV61000	21,05	AV161000	33,54	AV371000	42,78	AV71000	23,49	AV381000	39,96			
10,40	2,5	6,0	50	AV61040	20,67	AV161040	33,54	AV371040	42,78	AV71040	23,99	AV381040	39,85	112	AV151040	64,26
11,50	2,8	8,0	56	AV61150	21,16	AV161150	35,53	AV371150	45,99	AV71150	25,64	AV381150	43,32			
12,00	2,8	8,0	56	AV61200	21,16	AV161200	35,53	AV371200	45,99	AV71200	25,64	AV381200	43,32			
12,40	2,8	8,0	56	AV61240	21,16	AV161240	35,53	AV371240	45,99	AV71240	25,63	AV381240	43,32	112	AV151240	79,11
1/2"	2,9	8,0	56	AV6P1/2	22,20											
13,40	2,9	8,0	56	AV61340	22,88	AV161340	36,70	AV371340	47,50	AV71340	27,96	AV381340	43,97			
14,40	2,4	8,0	56	AV61440	24,98											
15,00	3,2	8,0	60	AV61500-8	30,24											
15,00	3,2	10,0	60	AV61500	29,05	AV161500	46,24	AV371500	62,60	AV71500	35,61	AV381500	51,36			
5/8"	3,2	8,0	60	AV6P5/8	31,24											
16,50	3,2	8,0	60	AV61650-8	30,24											
16,50	3,2	10,0	60	AV61650	28,56	AV161650	50,65	AV371650	65,04	AV71650	35,12	AV381650	58,57	120	AV151650	95,34
19,00	3,5	10,0	63	AV61900	42,78	AV161900	61,79	AV371900	78,93	AV71900	52,66	AV381900	71,53			
3/4"	3,5	8,0	63	AV6P3/4	42,78											
20,50	3,5	8,0	63	AV62050-8	44,66											
20,50	3,5	10,0	63	AV62050	42,04	AV162050	63,11	AV372050	81,30	AV72050	51,71	AV382050	72,44	124	AV152050	127,78
23,00	3,8	10,0	67	AV62300	52,58	AV162300	71,90	AV372300	90,98	AV72300	64,18	AV382300	84,12			
25,00	3,8	10,0	67	AV62500	53,06	AV162500	72,91	AV372500	91,93	AV72500	65,32	AV382500	85,25	128	AV152500	154,11
1"	3,8	10,0	67	AV6P1	54,96											
26,00	3,8	10,0	67	AV62600	57,02	AV162600	79,04									
28,00	4,0	12,0	71	AV62800	74,09	AV162800	92,68	AV372800	118,96	AV72800	93,29	AV382800	114,56			
30,00	4,2	12,0	71	AV63000	78,73	AV163000	96,16	AV373000	125,96	AV73000	98,66	AV383000	138,15			
31,00	4,2	12,0	71	AV63100	81,96	AV163100	102,16	AV373100	135,26	AV73100	98,66	AV383100	139,45	133	AV153100	180,53
40,00	4,5	13,0	112	AV64000	121,87	AV164000	152,12	AV374000	195,73	AV74000	154,03	AV384000	192,78			
45,00	4,5	13,0	116	AV64500	130,15											
50,00	5,0	13,0	125	AV65000	149,72											

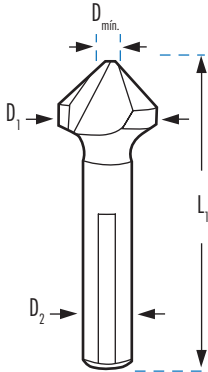

				AV66	AV67	AV99	AV55	AV6MD	AV66MD	AV55MD
MATERIAL				HSSCo	HSSCo	HSSCo	HSSCo	MD	MD	MD
ACABAMENTO					TiAIN	TiAIN				
APLICAÇÃO										
				3Z	3Z	3Z	5Z	3Z	3Z	5Z
D1 mm	D mín. mm	D2 mm	L1 mm	€	€	€	€	€	€	€
4,30	1,3	4,0	40					67,74		
5,30	1,5	4,0	40					65,22		
6,00	1,5	5,0	45					67,39		
6,30	1,5	5,0	45	22,46	29,19	41,70	4Z 29,19	72,86	81,35	4Z 101,69
8,00	2,0	6,0	50			54,96		77,62		
8,30	2,0	6,0	50	24,19	31,44	56,25	4Z 31,44	82,78	92,43	4Z 115,53
10,00	2,5	6,0	50			60,36		85,56		
10,40	2,5	6,0	50	29,11	37,85	63,85	4Z 37,85	90,29	100,81	4Z 126,01
11,50	2,8	8,0	56			68,55				
12,40	2,8	8,0	56	31,10	40,43	69,41	40,43	94,15	105,12	131,40
14,40	2,4	8,0	56	37,36	48,57					
15,00	3,2	10,0	60	43,21	56,18	85,86		98,06		
16,50	3,2	10,0	60	43,65	56,74	96,83	56,74	103,11	115,13	143,91
19,00	3,5	10,0	63			109,80				
20,50	3,5	10,0	63	57,73	75,05	119,75	75,05	142,97	159,63	199,54
23,00	3,8	10,0	67			130,15				
25,00	3,8	10,0	67	79,28	103,06	140,91	103,06	233,30	260,48	325,59
31,00	4,2	12,0	71	110,16	143,21	170,32	143,21	263,25	293,92	367,40
40,00	6,5	13,0	80	231,79	301,32	324,82		457,06*		
50,00	5,0	16,0	125	355,36	461,97					

* Cabo de 16 mm



Escareadores de corte variável antivibração.
Os escareadores de Nova Geração melhoram a qualidade do acabamento em funcionamento e prolongam a sua vida útil.
A ligeira assimetria nos cortes escareados aumenta o desempenho e reduz significativamente as vibrações durante a operação.
A disposição dos cortes no escareador contribui para uma operação de corte progressiva, aumenta o desempenho da ferramenta, melhorando o acabamento final, minimizando as irregularidades.
Os três planos de acionamento evitam escorregões, garantindo uma fixação firme do escareador ao mandril, evitando possíveis derrapagens e deslizamentos durante a utilização.



Escareamento HARDOX500 e materiais extremamente duros. Para escareadores em materiais de elevada dureza e HARDOX500, são recomendados os escareadores 5Z AV55 e AV55MD.
Modo de ação: É muito importante neste tipo de materiais, antes de começar a rodar o escareador para iniciar o corte, que o escareador já esteja em contacto com o material quando começa a rodar e aumentar gradualmente a velocidade à medida que começa a rodar. penetrar no material, evitando assim qualquer choque inicial, onde existe uma grande possibilidade de embotamento da aresta de corte ao aproximar-se da ferramenta.

ESCAREADORES HSS CABO CILÍNDRICO 60°, 75° E 120°

3Z

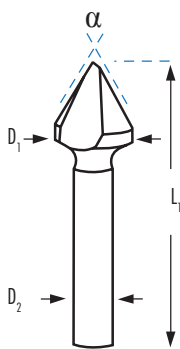

				AV8		AV9		AV10	
MATERIAL				HSS		HSS		HSS	
NORMA				DIN 334C		NORMA CELESA		NORMA CELESA	
ÂNGULO DA PONTA				60°		75°		120°	
D1 mm	D mín mm	D2 mm	L1 mm		€		€		€
6,30	1,5	5,0	45	AV80630	20,66	AV90630	15,90	AV100630	16,93
8,00	2,0	6,0	50	AV80800	22,71				
8,30	2,0	6,0	50			AV90830	21,68	AV100830	23,33
10,00	2,5	6,0	50	AV81000	24,77				
10,40	2,5	6,0	50			AV91040	25,62	AV101040	27,26
12,40	2,8	8,0	56	AV81250	27,47	AV91240	28,30	AV101240	32,64
16,50	3,2	10,0	60	AV81600	35,13	AV91650	35,50	AV101650	41,30
20,50	3,5	10,0	63	AV82000	49,58	AV92050	52,26	AV102050	60,93
25,00	3,8	10,0	67	AV82500	69,20	AV92500	65,88	AV102500	76,85
40,00	6,5	13,0	67	AV84000	158,97	AV94000	143,33	AV104000	168,91

ESCAREADORES MULTI-CORTE CABO CILÍNDRICO 60°, 90° E 120°

5Z

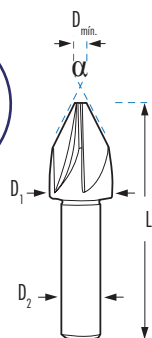

				AV12		AV11		AV13				
MATERIAL				HSS		HSS		HSS				
DIN				DIN 334A		DIN 335A		DIN 347A				
ÂNGULO DA PONTA				60°		90°		120°				
D1 mm	D mín mm	D2 mm	Nº Z	L1 mm	€	L1 mm	€	L1 mm	€			
8,00	2,5	8,0	5	AV120800	48	18,06	AV110800	44	13,58	AV130800	44	17,99
12,50	2,8	8,0	5	AV121250	52	25,27	AV111250	48	19,89	AV131250	48	26,42
16,00	3,0	10,0	5	AV121600	60	42,39	AV111600	56	33,39	AV131600	56	44,32
20,00	3,5	10,0	5	AV122000	64	54,68	AV112000	60	43,01	AV132000	60	57,14
25,00	3,5	10,0	5	AV122500	69	76,54	AV112500	65	60,21	AV132500*	65	77,73

* D2: 12,00 mm

ESCAREADORES HSS E HSSCO PARA REBARBAR COM FURO

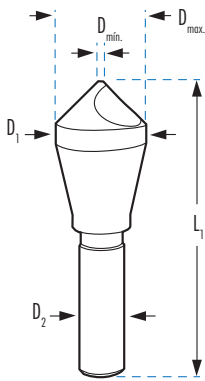

Escareadores

Rosa

MATERIAL					AV1		AV1T		AV2		AV2T		AV1-60	
ACABAMENTO					HSS		HSS		HSSCo		HSSCo		HSS	
ÂNGULO DA PONTA					90°		TiN 90°		90°		TiN 90°		60°	
D1 mm	Dmin mm	Dmax mm	D2 mm	L1 mm	€	€	€	€	€	€	€	€	€	
6,35	2,0	5,0	6,35	45	AV100	14,74	AV100T	26,63	AV200	25,05	AV200T	42,14	AV100-60	26,40
10,00	2,0	5,0	6,00	45	AV101	18,17	AV101T	27,85	AV201	25,87	AV201T	42,14	AV101-60	32,98
14,00	6,0	13,0	8,00	50	AV102	22,70	AV102T	39,15	AV202	30,13	AV202T	52,54	AV102-60	40,04
20,00	8,0	18,0	10,00	65	AV103	40,64	AV103T	70,00	AV203	53,86	AV203T	88,93	AV103-60	45,67
27,00	11,0	25,0	12,00	85	AV104	72,64	AV104T	115,07	AV204	87,76	AV204T	140,10	AV104-60	79,57
30,00	12,0	28,0	15,00	95	AV105	122,59	AV105T	218,37	AV205	139,43	AV205T	240,73	AV105-60	130,40
35,00	14,0	33,0	15,00	100	AV106	188,28	AV106T	299,01	AV206	233,61	AV206T	404,84	AV106-60	206,65
40,00	16,0	38,0	15,00	110	AV107	259,96	AV107T	424,96	AV207	268,79	AV207T	433,74	AV107-60	280,07
45,00	18,0	42,0	15,00	120	AV108	344,44	AV108T	516,12	AV208	403,95	AV208T	575,41	AV108-60	361,96
50,00	20,0	48,0	15,00	130	AV109	415,59	AV109T	600,06	AV209	538,38	AV209T	722,42	AV109-60	441,04

ESCAREADORES CÔNICOS 90° MULTI-NAVALHA

Ref. FC

TiAIN **MD**

D1 mm	D2 mm	L mm	L2 mm	D3 mm	Z	FC	€
0,5	0,1	39,0	3,0	3,0	3	FC0050	65,87
0,6	0,1	39,0	3,0	3,0	3	FC0060	65,87
0,7	0,1	39,0	3,0	3,0	3	FC0070	65,87
0,8	0,1	39,0	3,0	3,0	3	FC0080	65,87
0,9	0,1	39,0	3,0	3,0	3	FC0090	65,87
1,0	0,1	39,0	3,0	3,0	3	FC0100	63,59
1,5	0,1	39,0	4,5	3,0	3	FC0150	63,59
2,0	0,1	39,0	6,0	3,0	3	FC0200	63,59
2,5	0,1	39,0	7,5	3,0	3	FC0250	63,59
3,0	0,1	39,0	-	3,0	3	FC0300	63,59
4,0	0,8	54,0	-	4,0	4	FC0400	65,87
6,0	0,8	57,0	-	6,0*	4	FC0600	69,27
8,0	0,8	63,0	-	8,0*	5	FC0800	76,09
10,00	1,0	72,0	-	10,0*	6	FC1000	90,85
12,00	1,2	83,0	-	12,0*	6	FC1200	134,00
16,00	1,6	92,0	-	16,0*	6	FC1600	239,61
20,00	2,0	104,0	-	20,0*	6	FC2000	438,33

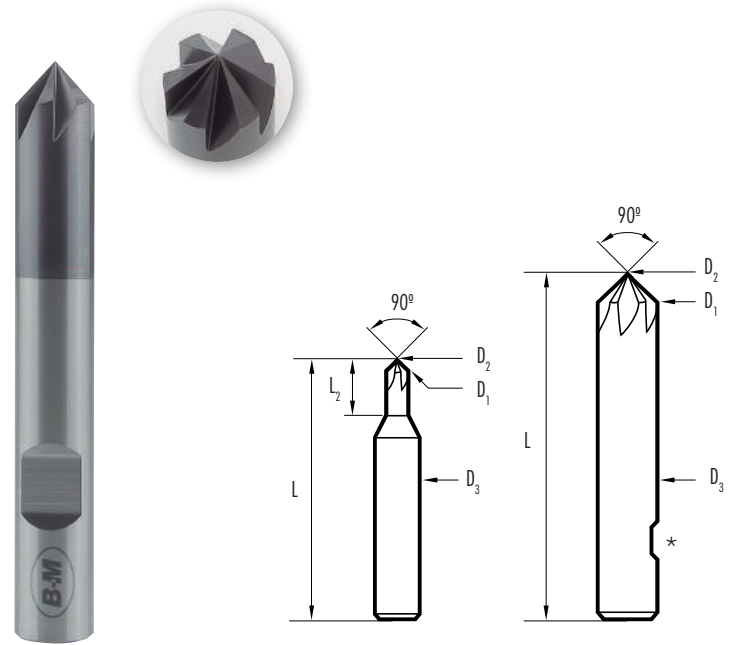

*Com plano de arrasto

ESCAREADORES COM CABO CÔNICO

3Z

Ref. AV17

DIN
335D

HSS



90°

Ref. AV17MD

DIN
335D

MD



90°

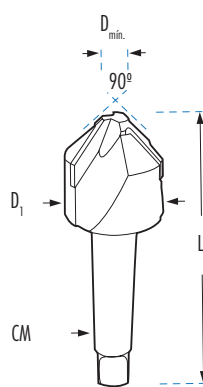
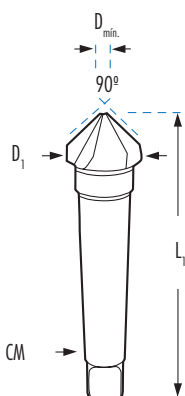

AV17

D1 mm	D mín. mm	L1 mm	CM	€
16,50	4,0	90	1	86,57
20,50	3,5	100	2	102,06
25,00	3,8	106	2	103,11
31,00	4,2	112	2	114,77
40,00	10,0	140	3	176,62
50,00	14,0	150	3	222,34
63,00	16,0	180	4	359,49
80,00	22,0	190	4	615,10
100,00	25,0	210	4	1.585,27

AV17MD

D1 mm	D mín. mm	L1 mm	CM	€
63,00	16,0	190	4	1.504,61 *
80,00	22,0	190	4	1.836,84 *

*Até o fim das existências.

ESCAREADORES MULTI-CORTE COM CABO CÔNICO

MULTI
CORTE

Ref. AV23

DIN
334B

60°

Ref. AV18

DIN
335B

90°

Ref. AV24

DIN
347B

120°

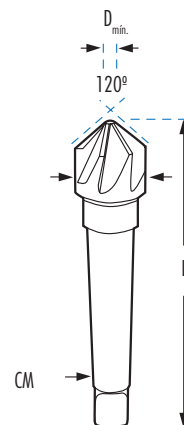
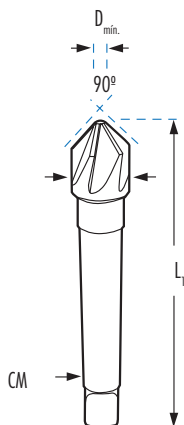
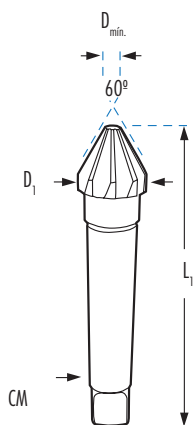

AV23

D1 mm	D mín. mm	L1 mm	CM	Z	HSS	€
16,00	3,2	93	1	7	HSS	65,68
20,00	4,0	116	2	7	HSS	76,89
25,00	7,0	121	2	9	HSS	84,22
31,50	9,0	124	2	9	HSS	115,16
40,00	12,5	150	3	11	HSS	210,77
50,00	16,0	153	3	13	HSS	251,95
63,00	20,0	185	4	15	HSS	385,70
80,00	25,0	196	4	17	HSS	596,10

AV18

D1 mm	D mín. mm	L1 mm	CM	Z	HSS	€
16,00	3,2	93	1	7	HSS	66,99
20,00	4,0	116	2	7	HSS	78,34
25,00	7,0	121	2	9	HSS	85,91
31,50	9,0	124	2	9	HSS	117,50
40,00	12,5	150	3	11	HSS	215,03
50,00	16,0	153	3	13	HSS	256,92
63,00	20,0	185	4	15	HSS	368,86
80,00	25,0	196	4	17	HSS	608,07
100,00	22,0	190	4	20	HSS	1.639,13

AV24

D1 mm	D mín. mm	L1 mm	CM	Z	HSS	€
16,00	3,2	93	1	7	HSS	68,22
20,00	4,0	116	2	7	HSS	79,84
25,00	7,0	121	2	9	HSS	91,69
31,50	9,0	124	2	9	HSS	119,61
40,00	12,5	150	3	11	HSS	190,46
50,00	16,0	153	3	13	HSS	246,01
63,00	20,0	185	4	15	HSS	400,53
80,00	25,0	196	4	17	HSS	619,03
100,00	27,0	210	4	3	HSS	1.624,65

ESCAREADORES DE 1 CANAL

HSS

CABO CILÍNDRICO
Ref. AV27
Ref. AV29



HSS

CABO CÓNICO
Ref. AV34
Ref. AV28

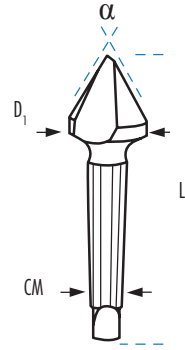
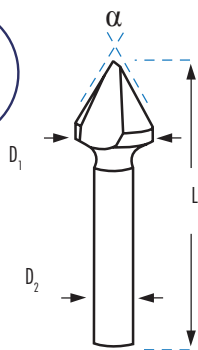
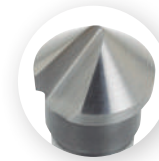





AV27

AV29

AV34

AV28

	D1 mm	D2 mm	L1 mm	 €	 €
AV270600	6,0	5,0	45	14,18	AV290600 26,16
AV270800	8,0	6,0	46	14,98	AV290800 27,40
AV271000	10,0	8,0	46	15,87	AV291000 28,69
AV271200	12,0	8,0	46	18,48	AV291200 32,23
AV271600	16,0	8,0	46,5	22,01	AV291600 39,24
AV272000	20,0	10,0	47	30,08	AV292000 50,44
AV272500	25,0	10,0	51	39,62	AV292500 79,42
AV273000	30,0	12,0	71	57,15	AV293000 103,72
AV274000	40,0	13,0	89	148,93	AV294000 180,29
AV275000	50,0	13,0	98	183,87	AV295000 269,35

	D1 mm	CM	L1 mm	 €	 €
AV341600	16,0	1	92	68,19	AV281600 65,24
AV342000	20,0	2	107	85,46	AV282000 71,47
AV342500	25,0	2	110	110,05	AV282500 105,97
AV343000	30,0	2	114	125,05	AV283000 139,64
AV344000	40,0	3	145	201,21	AV284000 183,86
AV345000	50,0	3	152	293,81	AV285000 279,21

ESCAREADORES EXTERNOS DE 3 CANAIS

3Z

Ref. AVX

HSS



90°

Ref. AVX-60

HSS



60°

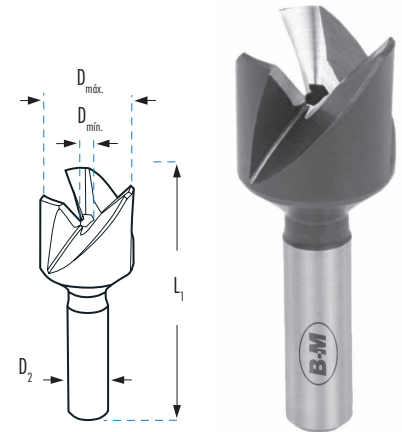

AVX

Dmáx. mm	Dmín. mm	D2 mm	L1 mm		€
12,00	4,0	8,0	55	AVX1	59,35
20,00	8,0	10,0	60	AVX2	110,56
28,00	10,0	13,0	70	AVX3	156,84
40,00	12,0	CM2	125	AVX4	238,00
50,00	15,0	CM3	130	AVX5	332,51

AVX-60

Dmáx. mm	Dmín. mm	D2 mm	L1 mm		€
8,00	3,0	8,0	55	AVX1-60	63,40
15,00	6,0	10,0	60	AVX2-60	121,66
28,00	10,0	13,0	75	AVX3-60	182,33

ESCAREADOR EXTERNO PARA REPARAÇÃO DE FIOS DE ENTRADA

Ref. AVEXT

HSS



60°



Min.-Max.		L1 mm		€
M8-M18	1/4"	75	AVEXT	28,11

ESCAREADOR EXTERNO PARA REPARAÇÃO DE FIOS DE ENTRADA DE METAL DURO

NEW

Ref. AVMDEXT

MD



60°

INOX



Min.-Max.			€
5-25 mm	1/4"	AVMDEXT	32,36

ESCREADORES PARA PARAFUSOS «ALLEN»

CABO CILÍNDRICO

DIN 373

HSS

Ref. AV2

NOTA: a longitude de corte entende-se sem a guia.

* O ajustamento grosso usa-se para escarear furos roscados.

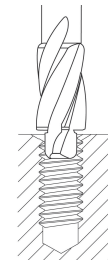
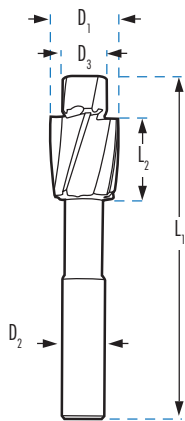

Para escarear furos roscados



AV2M

AV2MM

AV2GM

AJUSTAMENTO						D3 mm	FINO		D3 mm	MEIO		D3 mm	FURO ROSCADO
	D1 mm	D2 mm	L1 mm	L2 mm			€			€			€
M3	6,0	5,0	71	14	AV2M3	3,2	25,59	AV2MM3	3,4	27,70	AV2GM3	2,5	27,70
M4	8,0	5,0	71	14	AV2M4	4,3	25,59	AV2MM4	4,5	27,70	AV2GM4	3,3	27,70
M5	10,0	8,0	80	18	AV2M5	5,3	25,59	AV2MM5	5,5	27,70	AV2GM5	4,2	27,70
M6	11,0	8,0	80	18	AV2M6	6,4	28,84	AV2MM6	6,6	31,22	AV2GM6	5,0	31,22
M7	20,0	12,7	90	20	AV2M7	7,4	53,25						
M8	15,0	12,5	100	22	AV2M8	8,4	35,75	AV2MM8	9,0	38,70	AV2GM8	6,8	38,70
M10	18,0	12,5	100	22	AV2M10	10,5	42,56	AV2MM10	11,0	46,07	AV2GM10	8,5	46,07
M11	22,0	18,8	100	22	AV2M11	11,5	56,65						
M12	20,0	12,5	100	22	AV2M12	13,0	49,65	AV2MM12	14,0	53,75	AV2GM12	10,2	53,75
M14	24,0	12,5	100	22	AV2M14	15,0	77,66	AV2MM14	15,5	84,07	AV2GM14	12,0	84,07
M16	26,0	12,5	100	22	AV2M16	17,0	85,42	AV2MM16	17,5	92,46	AV2GM16	14,0	92,46

CABEÇA CÓNICA COM GUIA

DIN 1866

HSS

Ref. AV3

NOTA: A longitude de corte entende-se sem a guia.

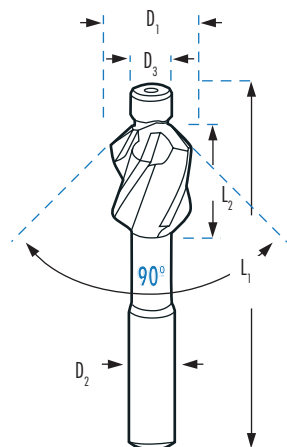

AJUSTAMENTO						D3 mm	FINO
	D1 mm	D2 mm	L1 mm	L2 mm			€
M3	6,3	6,0	71	14,0	AV3M3	3,2	35,00
M4	8,3	8,0	71	14,0	AV3M4	4,3	35,00
M5	10,4	10,0	80	18,0	AV3M5	5,3	35,00
M6	12,4	10,0	80	18,0	AV3M6	6,4	39,77
M8	16,5	12,0	100	22,0	AV3M8	8,4	48,67
M10	20,5	12,0	100	22,0	AV3M10	10,5	52,65
M12	24,5	13,0	110	25,0	AV3M12	13,0	64,18

ESCAREADORES PARA PARAFUSOS «ALLEN»

CABO CÓNICO

DIN
375

HSS

Ref. AV5

NOTA: A longitude de corte entende-se sem a guia.

* O ajustamento grosso usa-se para escarear furos roscados.

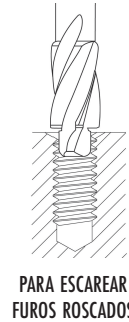
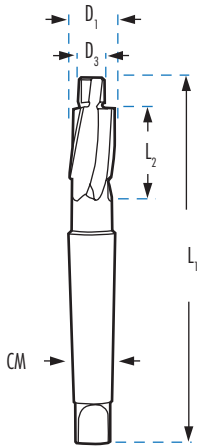
PARA ESCAREAR
FUROS ROSCADOS

AJUSTAMENTO					AV5M			AV5MM			AV5GM		
	D1 mm	CM	L1 mm	L2 mm	D3 mm	FINO		D3 mm	MEIO		D3 mm	FURO ROSCADO	
							€			€			€
M8	15,0	2	132	22	AV5M8	8,4	69,29				AV5GM8	6,8	69,29
M10	18,0	2	140	25	AV5M10	10,5	71,11	AV5MM10	11,0	71,11	AV5GM10	8,5	71,11
M12	20,0	2	140	25	AV5M12	13,0	78,68	AV5MM12	14,0	78,68	AV5GM12	10,2	78,68
M14	24,0	2	150	30	AV5M14	15,0	109,21	AV5MM14	15,5	109,21	AV5GM14	12,0	109,21
M16	26,0	3	180	35	AV5M16	17,0	128,25	AV5MM16	17,5	128,25	AV5GM16	14,0	128,25
M18	30,0	3	180	35	AV5M18	19,0	138,38	AV5MM18	20,0	138,38	AV5GM18	15,5	138,38
M20	33,0	3	190	40	AV5M20	21,0	150,77	AV5MM20	22,0	150,77	AV5GM20	17,5	150,77
M22	36,0	3	190	40	AV5M22	23,0	183,73	AV5MM22	24,0	183,73	AV5GM22	19,5	183,73
M24	40,0	3	190	40	AV5M24	25,0	222,11	AV5MM24	26,0	222,11	AV5GM24	21,0	222,11
M27	46,0	4	255	50	AV5M27	30,0	252,38						
M30	48,0	4	255	50	AV5M30	33,0	305,32						

APLICAÇÕES DOS TIPOS DE AJUSTAMENTOS: FINO, MEIO E FURO ROSCADO

T1: Parafusos cabeça cilíndrica DIN 84 e DIN 7984
Parafusos Auto-roscantes DIN 7513

T₂: Parafusos cabeça cilíndrica DIN 6912

T₃: Parafusos cabeça cilíndrica DIN 912

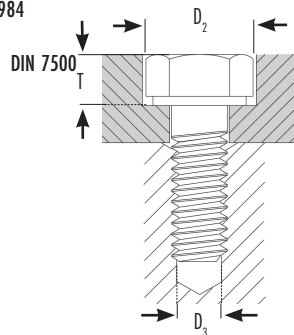

ROSCAS MÉTRICAS	AJUSTAMENTO			D2 mm	T1 mm	T2 mm	T3 mm
	FINO	MEIO	FURO ROSCADO				
M3	3,2	3,4	2,5	6,0	2,4	--	3,4
M4	4,3	4,5	3,3	8,0	3,2	3,4	4,6
M5	5,3	5,5	4,2	10,0	4,0	4,2	5,7
M6	6,4	6,6	5,0	11,0	4,7	4,8	6,8
M8	8,4	9,0	6,8	15,0	6,0	6,0	6,0
M10	10,5	11,0	8,5	18,0	7,0	7,5	11,0
M12	13,0	13,5	10,2	20,0	8,0	8,5	13,0
M14	15,0	15,5	12,0	24,0	9,0	9,5	15,0
M16	17,0	17,5	14,0	26,0	10,5	11,5	17,5
M18	19,0	20,0	15,5	30,0	11,5	12,5	19,5
M20	21,0	22,0	17,5	33,0	12,5	13,5	21,5
M22	23,0	24,0	19,5	36,0	13,5	14,5	23,5

ESCAREADORES COM ELEMENTOS INTERCAMBIÁVEIS PARA PARAFUSOS COM CABEÇA "ALLEN" E CÔNICA

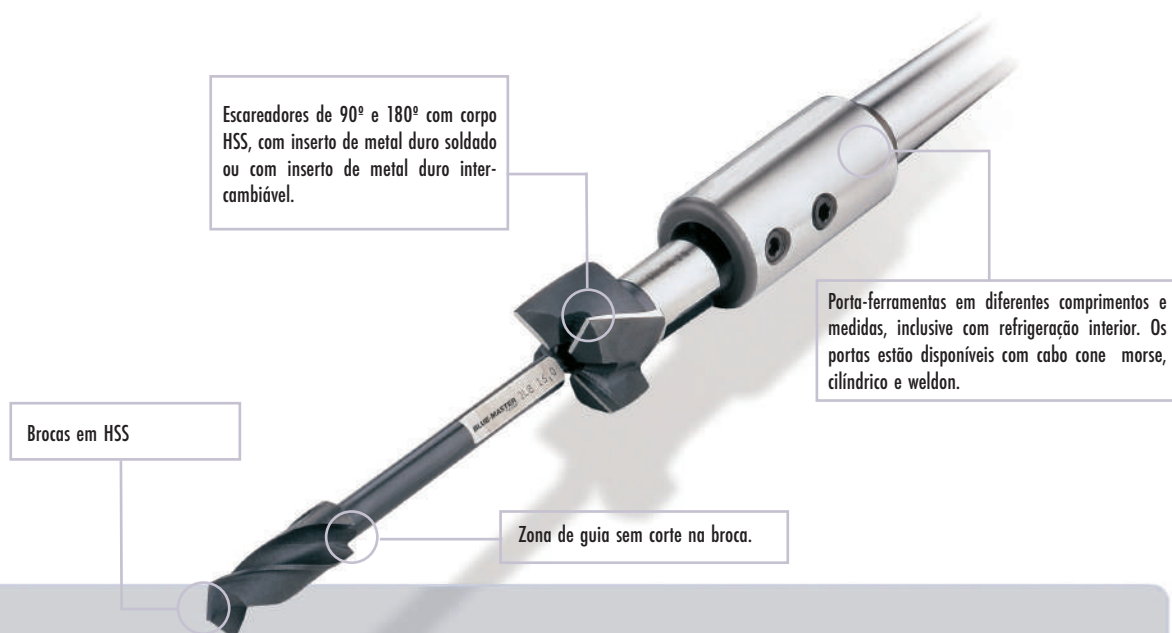

O SISTEMA BLUE-MASTER

O sistema BLUE-MASTER é único para operações de escareado, e ajuda a incrementar a produtividade e diminuir os custos.

Os nossos porta-ferramentas, fresas, brocas e guias podem combinar-se para adaptar-lhos a todos os tipos de máquinas e aplicações.

Você pode compor facilmente mais de 1.500.000 ferramentas especiais com só 1.300 peças.

O sistema consta de 3 grupos de dimensões: SERIE A, SERIE B e SERIE C.

Todas as combinações têm que fazer-se com elementos do mesmo grupo. Ferramentas de diferentes grupos não são combináveis entre si.

Nas seguintes páginas encontrará tanto as faixas de medidas disponíveis em cada grupo, como as recomendações para a correta escolha tanto da ferramenta como dos dados de corte.

Importante!

- * Com corte de metal duro colocar o parafuso de ajuste axial em contato com a guia da broca insertada.
- * Deixar um espaço entre o fio e a guia da broca para prevenir quebras por impacto accidental.
- * O parafuso axial também se usa para prolongar a vida das brocas depois de reafiar-lhas.

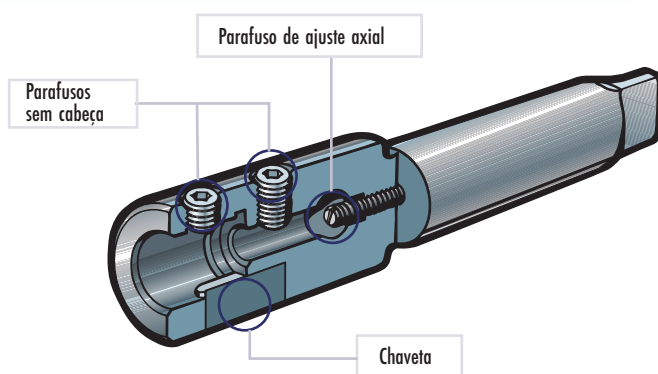

DIMENSÕES DE GUIA, PORTA E BROCA

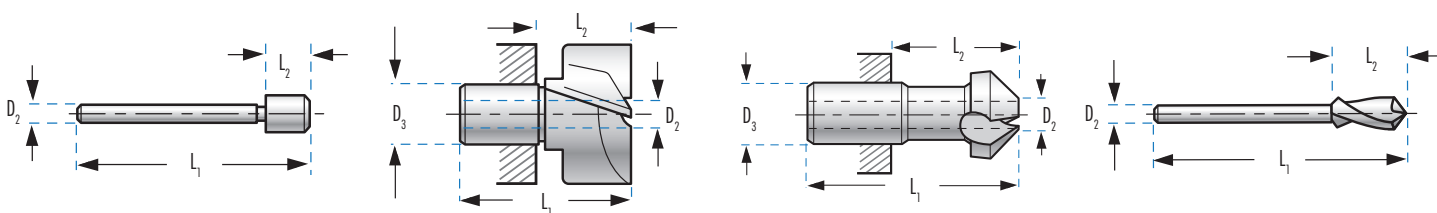

GUIA			PORTA				ESCAREADOR				BROCA					
D2 mm	L1 mm	L2 mm	D3 mm	D2 mm	L1 mm	L2 mm	D3 mm	D2 mm	L1 mm	L2 mm	D2 mm	L1 mm	L2 mm			
AGP	4	64	9	10	4	40	22	AVC	10	4	40	22	ABP	4	70	15
BGP	6	80	14	14	6	48	28	BVC	14	6	48	28	BBP	6	95	25
CGP	10	110	20	22	10	61	33	CVC	22	10	61	33	CBP	10	125	30

**ESCREADORES COM ELEMENTOS INTERCAMBIÁVEIS
PARA PARAFUSOS COM CABEÇA "ALLEN" E CÔNICA**

Escareadores

Rosa

**SERIE
B**

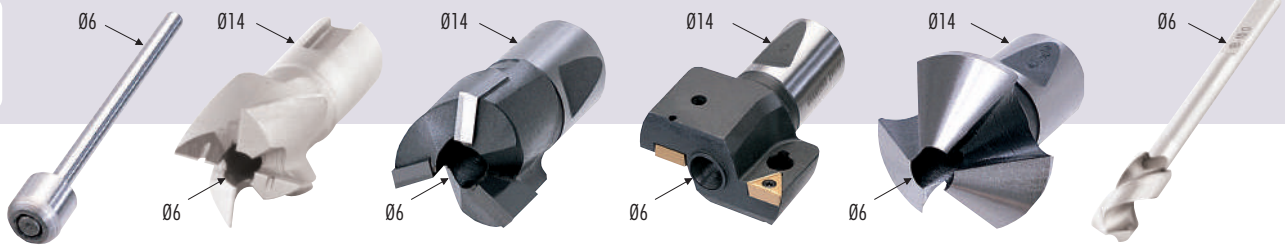

GUIA		PORTA		PORTA		PASTILHA INTERCAMBIÁVEL		ESCREADOR		BROCA	
BGP		BPAV		BPAVMD		BPAVPQ		BVC		BBP	
€	HSS €	MD €	Pastilha não incluída	PMD €	90° HSS €	HSS €					
		BPAV1300	157,56	BPAVMD1300	426,39						
		BPAV1350	177,92								
		BPAV1400	157,56	BPAVMD1400	426,39						
		BPAV1450	177,92								BBP0800 112,99
BGP0840	52,52										
BGP0900	52,52	BPAV1500	157,56	BPAVMD1500	426,39			BVC15	195,57		BBP0900 112,99
BGP0680	52,52										
BGP0800	52,52										
BGP1000	52,52	BPAV1550	180,35								
BGP1150	55,62	BPAV1600	166,21	BPAVMD1600	442,25						BBP0840 112,99
BGP1250	57,70	BPAV1650	192,79								BBP0850 112,99
BGP1350	63,57	BPAV1700	173,09	BPAVMD1700	442,25						BBP0950 112,99
BGP1450	64,25	BPAV1750	194,16								BBP1000 128,87
		BPAV1900	199,71	BPAVMD1900	446,08						BBP1050 128,87
BGP1050	55,62										
BGP1100	55,62	BPAV1800	179,67	BPAVMD1800	446,08						
BGP0850	52,52										
BGP1300	63,57										
BGP1400	64,25	BPAV2000	199,71	BPAVMD2000	459,88	BPAVPQ2000	910,15	BVC25	230,13		
BGP1020	55,62										
BGP1500	64,25										
BGP1550	64,25	BPAV2400	236,00	BPAVMD2400	488,57	BPAVPQ2400	911,32	BVC28	267,77		
BGP1200	55,62										
BGP1700	64,25										
BGP1750	64,25	BPAV2600	252,22	BPAVMD2600	491,33	BPAVPQ2600	1.044,89	BVC30	273,66		
BGP1400	64,25										
BGP1900	65,64										
BGP2000	81,89	BPAV3000	340,67	BPAVMD3000	535,91	BPAVPQ3000	1.044,89				
		BPAV3400	402,85	BPAVMD3400	618,08	BPAVPQ3400	1.206,05				

ADAPTADORES



BPH						
	D1 mm	D2 mm	L1 mm	L2 mm	CM Ømm	€
BPHCM1	24	14	123	62	CM1	369,72
BPHCM2	24	14	137	62	CM2	337,57
BPHCM3	24	14	160	66	CM3	369,72
BPH-12	24	14	120	55	Ø12	333,75

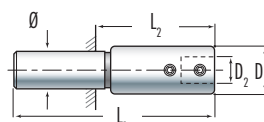
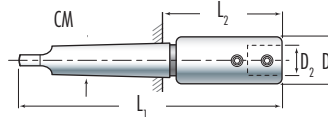

PASTILHAS DE REPOR

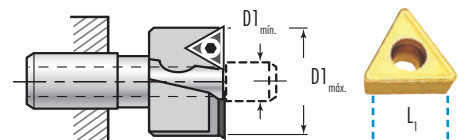

PPQ				
	L1 mm	D1 mín. Ømm	D1 máx. Ømm	€
PPQ07	7	20	25	34,56
PPQ10	10	26	33	31,11
PPQ12	12	34	36	31,11

ESCREADORES COM ELEMENTOS INTERCAMBIÁVEIS PARA PARAFUSOS COM CABEÇA "ALLEN" E CÓNICA

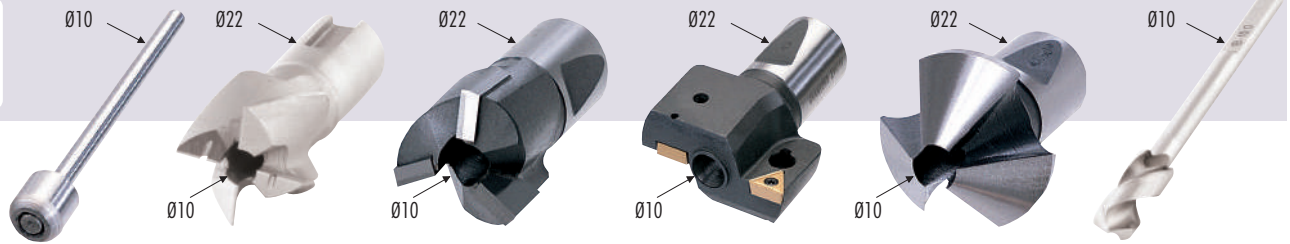
**SERIE
C**

GUIA

PORTA

PORTA

PASTILHA INTERCAMBIÁVEL

ESCREADOR

BROCA

CGP

CPAV

CPAVMD

CPAVPQ

CVC

CBP

CGP	€	CPAV		CPAVMD		CPAVPQ		CVC		CBP	
		HSS	€	MD	€	Pastilha não incluída	PMD	€	90°	HSS	€
CGP1200	59,77	CPAV2300	286,08	CPAVMD2300	533,12						
CGP1250	59,77	CPAV2400	289,86	CPAVMD2400	527,59						
CGP1300	59,77	CPAV2500	313,40	CPAVMD2500	528,64						
CGP1350	59,77	CPAV2600	319,61	CPAVMD2600	543,15						
CGP1400	70,14	CPAV2700	324,09								
CGP1450	70,14	CPAV2800	330,31	CPAVMD2800	548,33					CBP1700	282,30
CGP1500	70,14	CPAV2900	338,25							CBP1800	318,21
CGP1600	70,14	CPAV3100	367,63							CBP1900	333,75
CGP1650	70,14	CPAV3200	379,72	CPAVMD3200	598,77					CBP2100	361,77
CGP1700	70,14	CPAV3300	383,16							CBP2300	435,34
CGP1900	70,14										
CGP2000	70,14	CPAV3000	342,73	CPAVMD3000	604,65			CVC35	399,06	CBP2000	361,77
CGP1550	70,14										
CGP2100	78,09										
CGP2200	78,09	CPAV3400	387,00	CPAVMD3400	642,66	CPAVPQ3400	1.247,19	CVC37	422,22	CBP2200	403,56
CGP1750	70,14										
CGP1850	70,14	CPAV3500	405,29								
CGP2300	78,09										
CGP2400	78,09	CPAV3600	410,14	CPAVMD3600	660,27	CPAVPQ3600	1.247,19	CVC37	422,22	CBP2400	444,70
CGP1950	70,14										
CGP2500	78,09										
CGP2600	96,04	CPAV4000	476,13	CPAVMD4000	731,44	CPAVPQ4000	1.275,92	CVC40	448,82		
CGP2100	78,09										
CGP2200	78,09	CPAV4500	587,38			CPAVPQ4500	1.299,22				
CGP2050	78,09	CPAV5000	853,08			CPAVPQ5000	1.520,17				
		CPAV5500	898,68			CPAVPQ5500	1.795,45				
		CPAV6000	947,04			CPAVPQ6000	1.795,45				
		CPAV6500	1.065,23			CPAVPQ6500	2.053,27				

ADAPTADORES

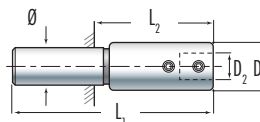
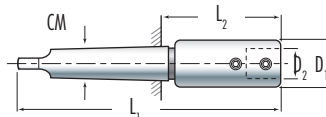

	D1 mm	D2 mm	L1 mm	L2 mm	CM Ømm	CPH
						€
CPHCM2	36	22	160	85	CM2	486,81
CPHCM3	36	22	180	87	CM3	459,88
CPHCM4	36	22	206	89	CM4	515,50
CPHCM5	36	22	240	91	CM5	1.134,34
CPH-12	36	22	140	71	Ø20	333,75

PASTILHAS DE REPOR

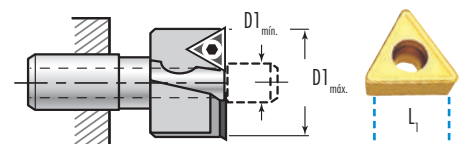

	L1 mm	D1 mín. Ømm	D1 máx. Ømm	PPQ
				€
PPQ12	12	34	45	31,11
PPQ17	17	<46		48,20

ESTOJOS DE ESCAREADORES

ESTOJOS DE BROCAS ESCAREADORAS PARA TUBO E CHAPA HSS E HSSCO

Escareadores

Rosa



Ref. PAV6CM2



Ref. PAV40BM2313

Metal Clássico

- Caixa metálica alta resistência.

M



Ref. AV40BM234



Ref. AV6CM3

Plástico Azul

- Rígido, robusto e leve.
- Janela transparente.
- Plástico reforçado com borracha anti-choque.

P

Referências iniciadas por "P"
São fornecidos em uma caixa de plástico.

AV40	Ref.	Uds.	CONTEÚDO	HSS	TiN	€
 HSS	PAV40BM234	3	P AV40BM2 (4-12 mm) AV40BM3 (4-20 mm) AV40BM4 (4-30 mm)	192,40	290,24	
	PAV40BM235	3	P AV40BM2 (4-12 mm) AV40BM3 (4-20 mm) AV40BM5 (6-38 mm)	309,18	427,57	
	PAV40BM2313	3	P AV40BM2 (4-12 mm) AV40BM3 (4-20 mm) AV40BM13 (6-40 mm)	386,72	475,50	
	AV40BM234	3	M AV40BM2 (4-12 mm) AV40BM3 (4-20 mm) AV40BM4 (4-30 mm)	192,40	290,24	
	AV40BM22122	3	M AV40BM2 (4-12 mm) AV40BM21 (7+10-20mm) AV40BM22 (10+20-30mm)	268,09	416,01	
AVC40				HSSCo	TiN	
HSSCo	AVC40BM234	3	M AVC40BM2 (4-12 mm) AVC40BM3 (4-20 mm) AVC40BM4 (4-30 mm)	227,65	371,75	
AV42				HSSCo	TiN	
HSSCo	AV42BM234	3	M AV42BM2 (4-12 mm) AV42BM3 (4-20 mm) AV42BM4 (4-30 mm)	218,50	324,43	
AV30				HSS	TiN	
 HSS	AV30BM012	3	M AV30BM0 (3-14 mm) AV30BM1 (6-20 mm) AV30BM2 (16-30 mm)	118,93	205,33	
AVC30				HSSCo	TiN	
 HSSCo	AVC30BM012	3	M AVC30BM0 (3-14 mm) AVC30BM1 (6-20 mm) AVC30BM2 (16-30 mm)	171,33	241,36	



AV40BM2 AV40BM3 AV40BM4 AV40BM5 AV40BM13

AVC40BM2 AVC40BM3 AVC40BM4



AV42BM2 AV42BM3 AV42BM4



AV30BM0 AV30BM1 AV30BM2

AVC30BM0 AVC30BM1 AVC30BM2

ESTOJOS DE ESCAREADORES

Escareadores

Rosa



AV16	Ref.	Uds.		CONTEÚDO	€
HSS	AV16CM1	6	M	Ø 6 - 8 - 10 11,5 - 15 - 19 mm	229,08
	AV16CM2	6	M	Ø 6,3 - 8,3 - 10,4 12,4 - 16,5 - 20,5 mm	234,81
TiN	AV16CM3	7	M	Ø 6,3 - 8,3 - 10,4 12,4 - 16,5 - 20,5 - 25 mm	307,72



Ref. PAV6CM2

Ref. AV16CM3



AV6	Ref.	Uds.		CONTEÚDO	€
HSS	AV6CM1	6	M	Ø 6 - 8 - 10 11,5 - 15 - 19 mm	145,16
	AV6CM2	6	M	Ø 6,3 - 8,3 - 10,4 12,4 - 16,5 - 20,5 mm	143,06
	AV6CM3	7	M	Ø 6,3 - 8,3 - 10,4 12,4 - 16,5 - 20,5 - 25 mm	196,11
	PAV6CM2	6	P	Ø 6,3 - 8,3 - 10,4 12,4 - 16,5 - 20,5 mm	143,06



AV7	Ref.	Uds.		CONTEÚDO	€
HSSCo	AV7CM1	6	M	Ø 6 - 8 - 10 11,5 - 15 - 19 mm	173,41
	AV7CM2	6	M	Ø 6,3 - 8,3 - 10,4 12,4 - 16,5 - 20,5 mm	171,79
	AV7CM3	7	M	Ø 6,3 - 8,3 - 10,4 12,4 - 16,5 - 20,5 - 25 mm	237,12
	PAV7CM2	6	P	Ø 6,3 - 8,3 - 10,4 12,4 - 16,5 - 20,5 mm	171,79

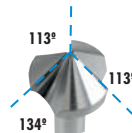

AV66	Ref.	Uds.		CONTEÚDO	€
HSSCo	PAV66CM2	6	P	Ø 6,3 - 8,3 - 10,4 12,4 - 16,5 - 20,5 mm	208,23



AV67	Ref.	Uds.		CONTEÚDO	€
HSSCo	PAV67CM2	6	P	Ø 6,3 - 8,3 - 10,4 12,4 - 16,5 - 20,5 mm	270,70

HARDOX
500

AV55	Ref.	Uds.		CONTEÚDO	€
HSSCo	PAV55CM2	6	P	Ø 6,3 - 8,3 - 10,4 12,4 - 16,5 - 20,5 mm	270,70



AV6MD	Ref.	Uds.		CONTEÚDO	€
MD	PAV6MDCM2	6	P	Ø 6,3 - 8,3 - 10,4 12,4 - 16,5 - 20,5 mm	586,17

HARDOX
500

AV55MD	Ref.	Uds.		CONTEÚDO	€
MD	PAV55MDCM2	6	P	Ø 6,3 - 8,3 - 10,4 12,4 - 16,5 - 20,5 mm	818,08



AV66MD	Ref.	Uds.		CONTEÚDO	€
MD	PAV66MDCM2	6	P	Ø 6,3 - 8,3 - 10,4 12,4 - 16,5 - 20,5 mm	654,47

ESTOJOS DE ESCAREADORES

DIN 334C

AV8	Ref.	Uds.		CONTEÚDO	€
	AV8CM2	6	M	Ø 6,3 - 8 - 10 12,5 - 16 - 20 mm	217,46
HSS	AV8CM3	7	M	Ø 6,3 - 8,0 - 10 12,5 - 16 - 20 - 25 mm	281,14

NORMA CELESA

AV9	Ref.	Uds.		CONTEÚDO	€
	AV9CM1	6	M	Ø 6,3 - 8,3 - 10,4 12,4 - 16,5 - 20,5 mm	222,42
HSS	AV9CM5	7	M	Ø 6,3 - 8,3 - 10,4 12,4 - 16,5 - 20,5 - 25 mm	287,82

* Outros estojos, AV99, etc., sob demanda.

90°

AV1	Ref.	Uds.		CONTEÚDO	€
HSS	AV1S2	5	M	Ø 10 - 14 20 - 27 - 30 mm	314,70

*Até o fim das existências.

HSS DIN 373

AV2M	Ref.	Uds.		CONTEÚDO	€
FINO	AV2M3-10	6	M	M3-M4-M5-M6-M8-M10	187,85
	AV2M3-12	7	M	M3-M4-M5-M6-M8-M10-M12	241,26

AV2MM	Ref.	Uds.		CONTEÚDO	€
MEIO	AV2M3-10M	6	M	M3-M4-M5-M6-M8-M10	203,37
	AV2M3-12M	7	M	M3-M4-M5-M6-M8-M10-M12	261,17

AV2GM	Ref.	Uds.		CONTEÚDO	€
FURO ROSCADO	AV2M3-10G	6	M	M3-M4-M5-M6-M8-M10	203,37
	AV2M3-12G	7	M	M3-M4-M5-M6-M8-M10-M12	261,17



AV8 AV9 AV10



Ref. AV10CM6

NORMA CELESA

AV10	Ref.	Uds.		CONTEÚDO	€
	AV10CM1	6	M	Ø 6,3 - 8,3 - 10,4 12,4 - 16,5 - 20,5 mm	250,23
HSS	AV10CM6	7	M	Ø 6,3 - 8,3 - 10,4 12,4 - 16,5 - 20,5 - 25 mm	309,74



AV1



AV2 AV2MM AV2GM



Ref. AV2M3-10

REBARBADOR DE PRECISÃO

OS REBARBADORES BLUE-MASTER

Os rebarbadores BLUE-MASTER são utilizados para eliminar as limanhas acumuladas nas bordas e arestas de peças fabricadas em metal, plástico ou madeira.

O sistema completa-se juntando os três componentes indicados: LÂMINA + PORTA-LÂMINAS + CABO UNIVERSAL

O cabo pode ser utilizado com todos os grupos de lâminas, trocando o porta-lâminas para cada um deles.

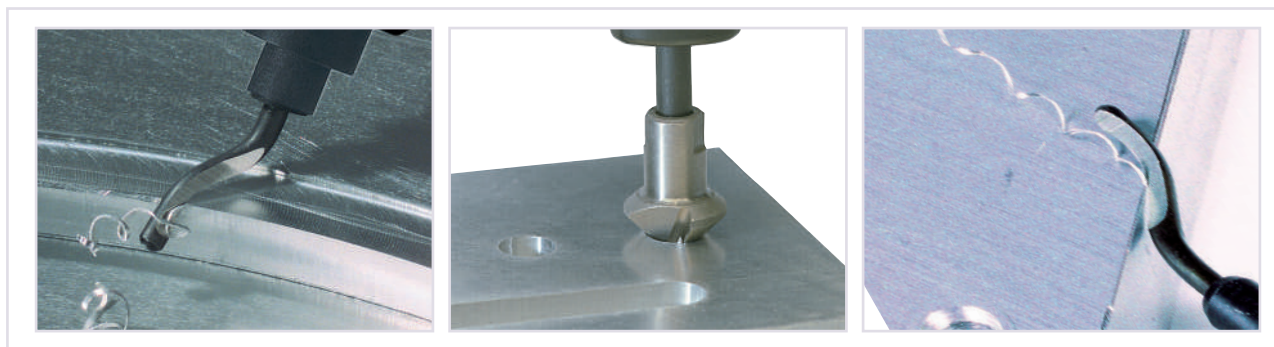
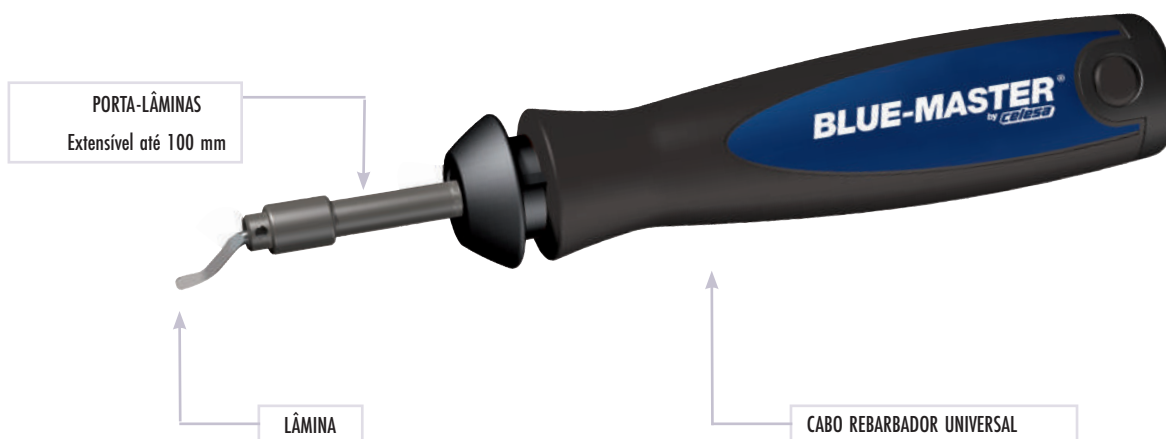

CONJUNTO B

JRB1

Conteúdo B:

Ref. RB10



Ref. RBB1

Ref. RB20



Ref. RBB

Blister: 33,63 €

CONJUNTO C

JRB2

Conteúdo C:

Ref. RC42



Ref. RBB1



Ref. RBC

Blister: 61,24 €

CONJUNTO D

JRB3

Conteúdo D:

Ref. RD80MD



Ref. RBB1



Ref. RBD

Blister: 96,54 €

CONJUNTO E

JRB4

Conteúdo E:

Ref. RE10



Ref. RE20

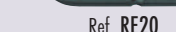

Ref. RE30

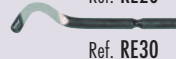

Ref. RBB1

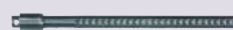

Ref. RBE

Blister: 37,45 €



REBARBADOR DE PRECISÃO

GRUPO B

PORTA-LÂMINAS GRUPO B

Ø2,6mm



Para lâminas rebarbadoras GRUPO B.

RBB

Blister 1 U.: **11,80 €**

LÂMINAS GRUPO B



Lâmina rebarbadora.
Serie curta: Aço, alumínio, fundição.

RB10*

Blister 10 U.: **2,18 €/U.**



Lâmina de punção de metal duro.

RB50*

Blister 1 U.: **38,85 €**



Lâmina rebarbadora bidirecional.
Serie curta: latão, fundição.

RB20

Blister 10 U.: **2,18 €/U.**



Lâmina rebarbadora para parte posterior duma furação de até 20mm de profundidade.

RB60*

Blister 10 U.: **5,16 €/Ud**



Lâmina rebarbadora dupla aresta furos de 4mm de profundidade.

RB30

Blister 10 U.: **2,18 €/U.**



Lâmina rebarbadora de arestas exteriores.

RB70MD*

Blister 1 U.: **44,20 €**

*Até o fim das existências.

GRUPO C

PORTA- LÂMINAS GRUPO C



Para lâminas rebarbadoras GRUPO C.

RBC

Blister 1 U.: **11,80 €**

LÂMINAS GRUPO C



Lâmina raspador largo 4 x 20 mm.

RC40*

Blister 1 U.: **24,06 €**



Lâmina raspador largo 8 x 30 mm.

RC42*

Blister 1 U.: **29,93 €**

*Até o fim das existências.

GRUPO D

PORTA- LÂMINAS GRUPO D



Para lâminas rebarbadoras GRUPO D.

RBD

Blister 1 U.: **11,80 €**

LÂMINAS GRUPO D



Lâmina rebarbadora de metal duro em "V" fêmea cantos de até 3 mm.

RD80MD*

Blister 1 U.: **62,90 €**



Lâmina rebarbadora de metal duro em "V" fêmea cantos de até 8 mm.

RD82MD*

Blister 1 U.: **98,61 €**

*Até o fim das existências.

CABO REBARBADOR UNIVERSAL

Utilizações gerais.
Válido para porta-lâminas:
Ref. RBB / RBC / RBD / RBE / RBF

**RBB1**Blister 1 ud.: **15,51 €**

REBARBADOR DE PRECISÃO

**GRUPO
E**

PORTA- LÂMINAS GRUPO E



Ø3,2mm

Para lâminas rebarbadoras Grupo E.

RBEBlister 1 ud.: **11,80 €**

LÂMINAS GRUPO E



Lâmina rebarbadora
para interiores e exteriores.
Serie longa: Aço, alumínio, plástico.

RE10Blister 10 ud.: **2,67 €**/Ud

Lâmina rebarbadora para cantos retos:
chaveteros, ...

RE35Blister 10 ud.: **2,86 €**/Ud

Lâmina rebarbadora bidirecional: latão, fundição.

RE20Blister 10 ud.: **2,67 €**/Ud

Lâmina rebarbadora fechada dupla aresta
para furos de 4mm de profundidade.

RE30Blister 10 ud.: **2,67 €**/Ud

Lâmina rebarbadora para parte posterior
duma furação de até 20mm de profundidade.

RE60*Blister 5 ud.: **3,75 €**/Ud

*Até o fim das existências.

**GRUPO
F**

PORTA- LÂMINAS GRUPO F



Para lâminas rebarbadoras Grupo F.

RBFBlister 1 ud.: **11,80 €**

LÂMINAS GRUPO F (Rosca M05 x 0,80)

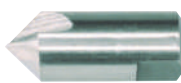

Lâmina escareadora HSS Ø 12 mm.

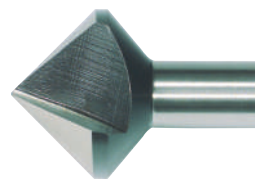
RF12Blister 1 ud.: **26,55 €**

Lâmina escareadora HSS Ø 30 mm.

RF30Blister 1 ud.: **88,72 €**

Lâmina escareadora HSS Ø 20 mm.

RF20Blister 1 ud.: **51,32 €**