



**BLUE-MASTER<sup>®</sup>**  
by *ce/esa*



AVELLANADORES

## BROCAS ESCALONADAS DE CANALES RECTOS HSS

HSS



Ref. AV40

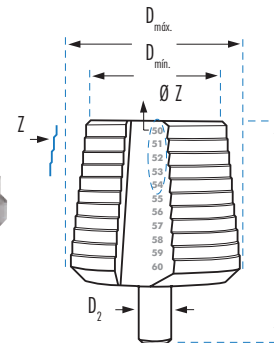
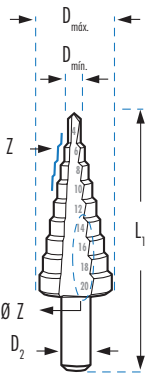

BM1

BM2

BM3

BM4

BM5

Ref. AV40BM25 / 26 / 27 / 28 / 29

AV40

	D min. mm	D max. mm	D2 mm	L1 mm	Z	Ø Z mm menor-mayor	HSS	TiN
							€	€
AV40BM1B	4,0	12,0	6,0	65	5	4-6-8-10-12	40,72	64,25
AV40BM2B	4,0	12,0	6,0	65	9	4-5-6-7-8-9-10-11-12	41,77	64,62
AV40BM3B	4,0	20,0	8,0	69	9	4-6-8-10-12-14-16-18-20	53,55	82,48
AV40BM4B	4,0	30,0	10,0	96	14	4-6-8-10-12-14-16-18-20-22-24-26-28-30	87,84	133,90
AV40BM14	4,0	39,0	10,0	107	13	4-6-9-12-15-18-21-24-27-30-33-36-39	217,94	336,55
AV40BM16B	5,0	28,0	10,0	69	7	5-8-8-11,8-15,3-19-24,5-28	101,09	159,09
AV40BM35B	5,0	35,0	13,0	80	13	5-7-10-12-15-17-20-22-25-27-30-32-35	130,87	190,28
AV40BM11B	6,0	25,0	10,0	65	7	6-9-12-16-20-22,50-25	82,55	111,11
AV40BM10B	6,0	26,7	10,0	75	8	6-9-11,40-14-17,25-19-21,25-26,75	160,73	252,93
AV40BM17B	6,0	30,5	10,0	80	9	6-9-12,5-15,2-18,6-20,4-22,5-28,3-30,5	170,65	268,53
AV40BM12B	6,0	32,0	10,0	75	9	6-9-12-16-20-22,5-25-28,5-32	116,51	140,22
AV40BM18B	6,0	37,0	10,0	100	12	6-9-12,5-15,2-18,6-20,4-22,5-26-28,3-30,5-34-37	189,65	293,96
AV40BM5B	6,0	38,0	10,0	96	12	6-9-13-16-19-21-23-26-29-32-35-38	204,62	271,25
AV40BM13	6,0	40,0	13,0	105	16	6-11-17-23-29-30-31-32-33-34-35-36-37-38-39-40	282,17	319,36
AV40BM15B	6,5	32,5	10,0	79	9	6,50-8,50-10,50-12,50-16,50-20,50-25,50-29-32,50	134,90	189,06
AV40BM20	6,5	40,5	10,0	96	11	6,50-8,50-10,50-12,50-16,50-20,50-25,50-29	211,49	332,81
AV40BM21B	7,0	20,0	10,0	80	12	32,50-36,50-40,50	84,62	133,16
AV40BM22B	10,0	30,0	13,0	83	12	7-10-11-12-13-14-15-16-17-18-19-20	132,46	207,81
AV40BM25B	12,0	20,0	8,0	66	9	10-20-21-22-23-24-25-26-27-28-29-30	78,46	105,01
AV40BM26B	20,0	30,0	10,0	78	11	12-13-14-15-16-17-18-19-20	114,45	161,23
AV40BM27	30,0	40,0	10,0	78	11	20-21-22-23-24-25-26-27-28-29-30	171,42	220,70
AV40BM28	40,0	50,0	13,0	85	11	30-31-32-33-34-35-36-37-38-39-40	245,06	341,55
AV40BM29	50,0	60,0	13,0	85	11	40-41-42-43-44-45-46-47-48-49-50	308,77	383,55
AV40BM29	50,0	60,0	13,0	85	11	50-51-52-53-54-55-56-57-58-59-60		

## PARA PASAR TUBERÍAS ROSCA GAS

AV40BM6B	6,0	32,0	10,0	75	8	6-9-11,20(1/8)-14,50(1/4)-18,20(3/8)-22,30(1/2)-27,90(3/4)-32	120,88	165,71
----------	-----	------	------	----	---	---	--------	--------

## PARA REMACHES CIEGOS M3 - M4 - M5 - M6 Y M7

AV40BM7B	4,8	10,6	6,0	54	5	4,80-6,40-7,20-9,60-10,65	39,39	56,20
----------	-----	------	-----	----	---	---------------------------	-------	-------

## PARA CONDUCCIONES ELÉCTRICAS (ANTIGUA Y NUEVA NORMA)

AV40PG21B	PG7	PG21	13,0	70	11	6,5-8,5-10,5-12,5(PG7)-15,2(PG9)-18,6(PG11) 20,4(PG13,5)-22,5(PG16)-25,5-18,3(PG21)-30,5	133,11	188,18
AV40PG29B	PG7	PG29	13,0	81	14	6,5-9-11-12,5(PG7)-15,2(PG9)-18,6(PG11)-20,4(PG13,5) 22,5(PG16)-26-28,3(PG21)-30,5-33-35-37(PG29)	171,96	241,23
AV40BM8B	8,5	32,5	10,0	70	12	8,5-10,5-12,5-14,5-16,5-18,5-20,5-23,5-25,5 28-30,5-32,5	100,91	146,22
AV40BM9B	8,5	40,5	12,0	84	16	8,5-10,5-12,5-14,5-16,5-18,5-20,5-23,5-25,5 28-30,5-32,5-34,5-36,5-38,5-40,5	143,69	216,55

**BROCAS ESCALONADAS DE CANALES RECTOS HSSCO**

**HSSCo** **INOX** Ref. AVC40

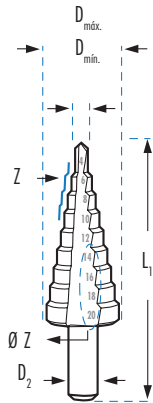

	D mín. mm	D máx. mm	D2 mm	L1 mm	Z	Ø Z mm menor-mayor	AVC40	
							HSSCo €	TiN €
AVC40BM1B	4,0	12,0	6,0	65	5	4-6-8-10-12	50,08	76,78
AVC40BM2B	4,0	12,0	6,0	65	9	4-5-6-7-8-9-10-11-12	52,88	92,74
AVC40BM3B	4,0	20,0	8,0	69	9	4-6-8-10-12-14-16-18-20	64,94	105,07
AVC40BM4B	4,0	30,0	10,0	96	14	4-6-8-10-12-14-16-18-20-22-24-26-28-30	100,59	164,70
AVC40BM18B	6,0	37,0	10,0	100	12	6-9-12,5-15,2-18,6-20,4-22,5-26-28,3-30,5-34-37	205,94	309,27

**BROCAS ESCALONADAS DE CANALES RECTOS HSS SDS-PLUS**

**NEW** **HSS** **SDS Plus**

Ref. AV40BMSDS

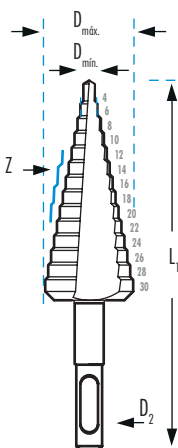

	D mín. mm	D máx. mm	D2 mm	L1 mm	Z	Ø Z mm menor-mayor	AV40BMSDS	
							HSS €	TiN €
AV40BMSDS1B	4,0	12,0	8,8	95,5	5	4-6-8-10-12	43,16	68,11
AV40BMSDS2B	4,0	12,0	8,8	95,5	9	4-5-6-7-8-9-10-11-12	44,27	68,50
AV40BMSDS3B	4,0	20,0	8,8	104,0	9	4-6-8-10-12-14-16-18-20	56,76	87,43
AV40BMSDS4B	4,0	30,0	8,8	126,0	14	4-6-8-10-12-14-16-18-20-22-24-26-28-30	93,11	141,93

## BROCAS ESCALONADAS DE CANALES HELICOIDALES HSS

HSS

Ref. AV42



BM2

BM3

BM4

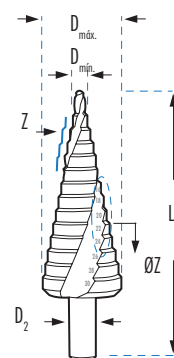

AV42

	D mín. mm	D máx. mm	D2 mm	L1 mm	Z	Ø Z mm menor-mayor	HSS	TiN
							€	€
AV42BM1B	4,0	12,0	6,0	65	5	4-6-8-10-12	45,71	65,46
AV42BM2B	4,0	12,0	6,0	68	9	4-5-6-7-8-9-10-11-12	46,17	68,17
AV42BM3B	4,0	20,0	8,0	69	9	4-6-8-10-12-14-16-18-20	61,59	95,30
AV42BM4B	4,0	30,0	10,0	96	14	4-6-8-10-12-14-16-18-20-22-24-26-28-30	101,51	151,72
AV42BM5B	6,0	38,0	10,0	96	12	6-9-13-16-19-21-23-26-29-32-35-38	218,71	285,25
AV42BM11B	6,0	25,0	10,0	65	7	6-9-12-16-20-22,50-25	85,98	119,36
AV42BM12B	6,0	32,0	10,0	75	9	6-9-12-16-20-22,5-25-28,5-32	124,60	159,36
AV42BM13	6,0	40,0	13,0	105	16	6-11-17-23-29-30-31-32-33-34-35-36-37-38-39-40	288,78	326,36
AV42BM8B	8,5	32,5	10,0	70	12	8,5-10,5-12,5-14,5-16,5-18,5-20,5-23,5 25,5-28-30,5-32,5	113,18	155,25
AV42BM9B	8,5	40,5	12,0	84	16	8,5-10,5-12,5-14,5-16,5-18,5-20,5-23,5 25,5-28-30,5-32,5-34,5-36,5-38,5-40,5	177,98	231,55

## BROCAS MEGA ESCALONADAS DE CANALES HELICOIDALES HSS

NEW

HSS

Ref. AV42BM7



AV42BM702B AV42BM703B AV42BM704B

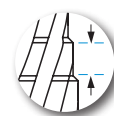

ESCALÓN 10 mm

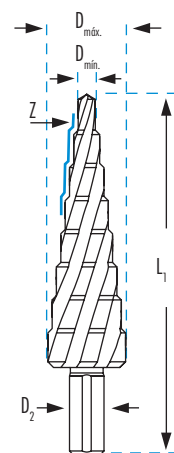
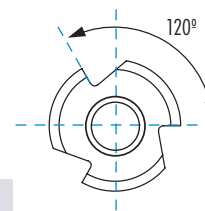

AV42

	D mín. mm	D máx. mm	D2 mm	L1 mm	Z	Ø Z mm menor-mayor	HSS	TiN
							€	€
AV42BM702B	6,0	12,0	6,0	105	7	6-7-8-9-10-11-12	45,95	51,05
AV42BM703B	6,0	20,0	10,0	120	8	6-8-10-12-14-16-18-20	72,11	80,12
AV42BM704B	6,0	27,0	12,0	125	8	6-9-12-15-18-21-24-27	94,88	105,42

**BROCA MICROESCALONADAS HSS**



Avellanadores

Rosa

**STEP CUT**

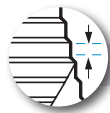
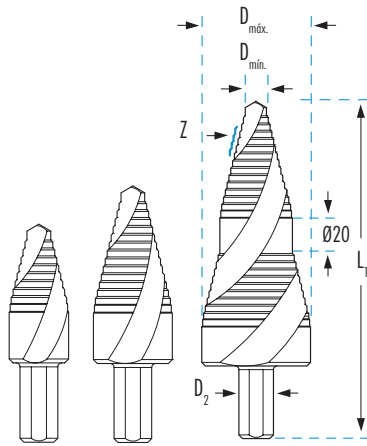

ESCALÓN 2 mm



AV40BM37

AV40BM38

AV40BM36

	D mín. mm	D máx. mm	D <sub>2</sub> mm	L1 mm	Z	Ø Z mm menor-mayor	AV40BM	
							HSS	TiN
							€	€
AV40BM37B	6,0	15,0	9,5	55	11	6-7-8-9-10-11-12-13-14-14,5-15	27,75	36,42
AV40BM38B	6,0	20,0	9,5	65	16	6-7-8-9-10-11-12-13-14-15-16-17-18-19-19,5-20	41,49	57,02
AV40BM36B	6,0	30,0	9,5	93	27	6-7-8-9-10-11-12-13-14-15-16-17-18-19-19,5-20-21-22-23-24-25-26-27-28-29-29,5-30	102,31	147,33

**MANGO HEXAGONAL 1/4"**

	D mín. mm	D máx. mm	Hexagon	L1 mm	Z	Ø Z mm menor-mayor	AV41	
							HSS	TiN
							€	€
AV41BM2B	4,0	12,0	1/4"	72	9	4-5-6-7-8-9-10-11-12	46,17	68,17
AV41BM3B	4,0	20,0	1/4"	81	9	4-6-8-10-12-14-16-18-20	61,59	95,30
AV41BM4B	4,0	30,0	1/4"	105	14	4-6-8-10-12-14-16-18-20-22-24-26-28-30	101,51	151,72



Ref. AV41BM2B

**SERIE CORTA Máximo 2 mm de espesor**

	D mín. mm	D máx. mm	D2 mm	L1 mm	Z	Ø Z mm menor-mayor	AV41C	
							HSS	TiN
							€	€
AV41CBM2B	4,0	12,0	6,0	48	9	4-5-6-7-8-9-10-11-12	50,94	68,37
AV41CBM3B	4,0	20,0	8,0	58	9	4-6-8-10-12-14-16-18-20	63,24	88,36
AV41CBM4B	4,0	30,0	10,0	72	14	4-6-8-10-12-14-16-18-20-22-24-26-28-30	103,10	158,74



Ref. AV41CBM3B

## BROCAS ESCALONADAS HSS CARACTERÍSTICAS ESPECIALES

HSS

Avellanadores

Rosa

## ATORNILLAMIENTOS MÉTRICOS DE CABLE

	DIN	D mín. mm	D máx. mm	D2 mm	L1 mm	Z	Ø Z mm menor-mayor	AV45	
								HSS €	TiN €
AV45BM0B	60423	5,3	30,5	10,0	79	9	5,3-7-9-10,5-14,5-18,5-23,5-27-30,5	180,94	233,33
AV45BM2B	60423	5,3	38,5	10,0	96	11	5,3-7-9-10,5-14,5-18,5-23,5-27-30,5-34,5-38,5	217,59	274,91



Ref. AV45BM2B

## ESCALONADA RECTA CON 3 CORTES

	D mín. mm	D máx. mm	D2 mm	L1 mm	Z	Ø Z mm menor-mayor	AV43	
							HSS €	TiN €
AV43BM1B	4,0	12,0	6,0	65	9	4-5-6-7-8-9-10-11-12	47,58	75,36
AV43BM2B	4,0	20,0	8,0	75	9	4-6-8-10-12-14-16-18-20	65,23	101,07
AV43BM3B	4,0	30,0	10,0	100	14	4-6-8-10-12-14-16-18-20-22-24-26-28-30	100,54	164,44



Ref. AV43BM3B

## BROCA ESCALONADA CON BROCA GUÍA INTERCAMBIABLE

	D mín. mm	D máx. mm	D2 mm	L1 mm	Z	Ø Z mm menor-mayor	AV4	
							HSS €	
AV4BM3040	30,0	40,0	13,0	76	11	30-31-32-33-34-35-36-37-38-39-40	165,83	
AV4BM4050	40,0	50,0	13,0	76	11	40-41-42-43-44-45-46-47-48-49-50	239,52	
AV4BM5060	50,0	60,0	13,0	76	11	50-51-52-53-54-55-56-57-58-59-60	304,05	



Ref. AV4BM3040

## BROCA GUÍA



	DESCRIPCIÓN	BAV4BM €
BAV4BM	10X35mm	10,73

**BROCAS AVELLANADORAS PARA TUBO Y CHAPA HSS Y HSSCO**

**HSS**

**HSSCo**

Ref. AV30  
Ref. AVC30

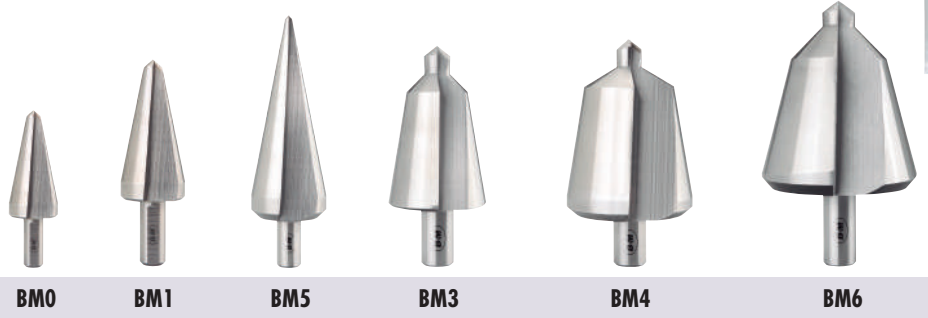

D mín. mm	D máx. mm	D2 mm	L1 mm	AV30		AVC30		
				HSS €	TiN €	HSSCo €	TiN €	
3,0	14,0	6,0	58	20,13	40,23	AVC30BM0B	37,26	48,67
3,0	22,5	8,0	85	55,65	100,85			
3,0	31,0	10,0	102	88,99	133,36			
5,0	25,4	10,0	87	63,28	120,89			
6,0	20,0	8,0	63	28,40	58,71	AVC30BM1B	49,40	75,03
16,0	30,0	10,0	79	54,93	97,15	AVC30BM2B	81,51	108,68
26,0	40,0	13,0	86	113,65	177,97	AVC30BM3B	164,73	228,88
36,0	50,0	13,0	89	167,40	258,22	AV30BM4		
40,0	61,0	13,0	98	277,32	431,87	AV30BM6		

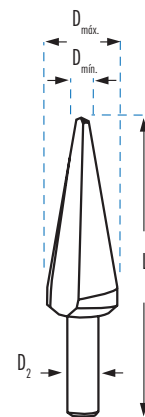

\*Las referencias acabadas en B, se suministran en blíster.

**BROCAS AVELLANADORAS PARA CHAPA HSS CARACTERISTICAS ESPECIALES**

**HSS**

Ref. AG

Broca-avellanadora para cortar tubo y chapa de acero y aleaciones ligeras, materiales plásticos. Indicado hasta 5 mm de profundidad.

**HSS**

Ref. AV31

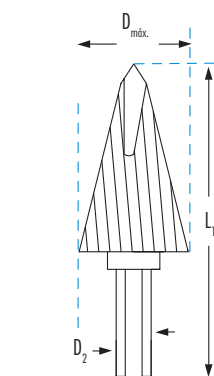

**FRESA PARA TUBO Y CHAPA**

	D máx. mm	D2 mm	L1 mm	Nº dientes	AG
					HSS €
AG2500	25,0	8,0	72	20	28,42
AG3200	32,0	10,0	81	30	42,67
AG4500	45,0	10,0	94	36	70,48

**TOPE DE PROFUNDIDAD**

	D mín. mm	D máx. mm	D2 mm	L1 mm	AV31	
					HSS €	TiN €
AV31BMOB	3,0	7,8	6,0	48	32,26	48,82
AV31BM1B	3,0	10,2	6,0	52	42,36	66,41
AV31BM2B	3,0	11,8	6,0	56	47,14	83,31



**NEW**

**DIN 335C**

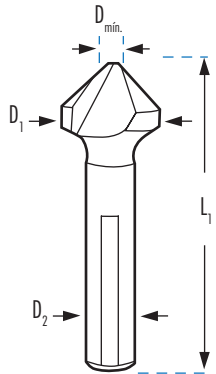
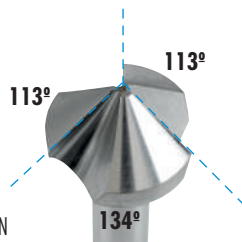

				AV66	AV67	AV99	AV55	AV6MD	AV66MD	AV55MD
<b>MATERIAL</b>				HSSCo	HSSCo	HSSCo	HSSCo	MD	MD	MD
<b>ACABADO</b>					TiAlN	TiAlN				
<b>APLICACIÓN</b>										
				3Z	3Z	3Z	5Z	3Z	3Z	5Z
D1 mm	D mín. mm	D2 mm	L1 mm	€	€	€	€	€	€	€
4,30	1,3	4,0	40					67,74		
5,30	1,5	4,0	40					65,22		
6,00	1,5	5,0	45					67,39		
6,30	1,5	5,0	45	22,46	29,19	41,70	4Z 29,19	72,86	81,35	4Z 101,69
8,00	2,0	6,0	50			54,96		77,62		
8,30	2,0	6,0	50	24,19	31,44	56,25	4Z 31,44	82,78	92,43	4Z 115,53
10,00	2,5	6,0	50			60,36		85,56		
10,40	2,5	6,0	50	29,11	37,85	63,85	4Z 37,85	90,29	100,81	4Z 126,01
11,50	2,8	8,0	56			68,55				
12,40	2,8	8,0	56	31,10	40,43	69,41	40,43	94,15	105,12	131,40
14,40	2,4	8,0	56	37,36	48,57					
15,00	3,2	10,0	60	43,21	56,18	85,86		98,06		
16,50	3,2	10,0	60	43,65	56,74	96,83	56,74	103,11	115,13	143,91
19,00	3,5	10,0	63			109,80				
20,50	3,5	10,0	63	57,73	75,05	119,75	75,05	142,97	159,63	199,54
23,00	3,8	10,0	67			130,15				
25,00	3,8	10,0	67	79,28	103,06	140,91	103,06	233,30	260,48	325,59
31,00	4,2	12,0	71	110,16	143,21	170,32	143,21	263,25	293,92	367,40
40,00	6,5	13,0	80	231,79	301,32	324,82		457,06*		
50,00	5,0	16,0	125	355,36	461,97					

\* Mango de 16 mm



**Avellanadores de Corte Variable Antivibración.**

Avellanadores de nueva Generación, mejoran la calidad del acabado en la operación y alargan su vida útil.

La ligera asimetría en los cortes del avellanador, aumenta el rendimiento y disminuye significativamente las vibraciones durante la operación.

La disposición de los cortes en el avellanador, contribuye a una operación de corte progresiva, aumenta el rendimiento de la herramienta, mejorando el acabado final, minimizando las irregularidades.

Los tres planos de arrastre previenen el deslizamiento, asegurando un amarre firme del avellanador en el portabrocas evitando posibles patinazos y deslizamientos durante su uso.



Avellanado de HARDOX500 y Materiales de Extrema Dureza.

Para avellanados en materiales de Alta Dureza y HARDOX500, se recomiendan los avellanadores AV55 y AV55MD de 5Z.

**Modo de Actuación:** Es muy importante, en este tipo de materiales, que antes de comenzar a rotar el avellanador para empezar a cortar, la herramienta ya esté en contacto con el material. Posteriormente, comienza a girar e incrementa la velocidad de manera progresiva mientras empieza a penetrar en el material. De esta manera, se evita cualquier choque inicial, donde existe una alta posibilidad de despuntar el filo de corte en la aproximación de la herramienta.

## AVELLANADORES HSS MANGO CILÍNDRICO 60°, 75°, 120°

3Z

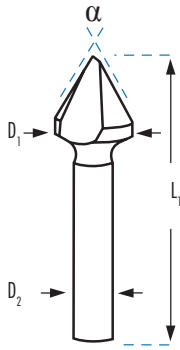

				AV8		AV9		AV10	
MATERIAL				HSS		HSS		HSS	
NORMA				DIN 334C		NORMA CELESA		NORMA CELESA	
ÁNGULO DE PUNTA				60°		75°		120°	
D1 mm	D mín mm	D2 mm	L1 mm		€		€		€
6,30	1,5	5,0	45	AV80630	20,66	AV90630	15,90	AV100630	16,93
8,00	2,0	6,0	50	AV80800	22,71				
8,30	2,0	6,0	50			AV90830	21,68	AV100830	23,33
10,00	2,5	6,0	50	AV81000	24,77				
10,40	2,5	6,0	50			AV91040	25,62	AV101040	27,26
12,40	2,8	8,0	56	AV81250	27,47	AV91240	28,30	AV101240	32,64
16,50	3,2	10,0	60	AV81600	35,13	AV91650	35,50	AV101650	41,30
20,50	3,5	10,0	63	AV82000	49,58	AV92050	52,26	AV102050	60,93
25,00	3,8	10,0	67	AV82500	69,20	AV92500	65,88	AV102500	76,85
40,00	6,5	13,0	67	AV84000	158,97	AV94000	143,33	AV104000	168,91

## AVELLANADORES MULTICORTE MANGO CILÍNDRICO 60°, 90° Y 120°

5Z

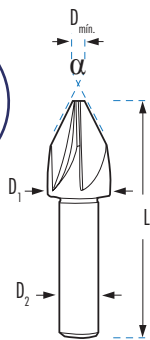

				AV12		AV11		AV13				
MATERIAL				HSS		HSS		HSS				
DIN				DIN 334A		DIN 335A		DIN 347A				
ÁNGULO DE PUNTA				60°		90°		120°				
D1 mm	D mín mm	D2 mm	Nº Z	L1 mm	€	L1 mm	€	L1 mm	€			
8,00	2,5	8,0	5	AV120800	48	18,06	AV110800	44	13,58	AV130800	44	17,99
12,50	2,8	8,0	5	AV121250	52	25,27	AV111250	48	19,89	AV131250	48	26,42
16,00	3,0	10,0	5	AV121600	60	42,39	AV111600	56	33,39	AV131600	56	44,32
20,00	3,5	10,0	5	AV122000	64	54,68	AV112000	60	43,01	AV132000	60	57,14
25,00	3,5	10,0	5	AV122500	69	76,54	AV112500	65	60,21	AV132500*	65	77,73

\* D2: 12,00 mm

**AVELLANADORES HSS Y HSSCO PARA DESBARBAR CON AGUJERO**

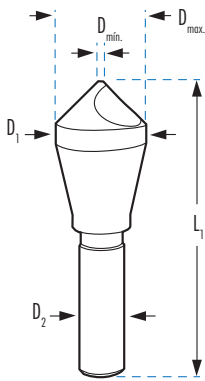

Avellanadores

Rosa

MATERIAL					AV1		AV1T		AV2		AV2T		AV1-60	
ACABADO					HSS		HSS		HSSCo		HSSCo		HSS	
ÁNGULO DE PUNTA														
D1 mm	Dmin mm	Dmax mm	D2 mm	L1 mm	€	€	€	€	€	€	€	€	€	
6,35	2,0	5,0	6,35	45	AV100	<b>14,74</b>	AV100T	<b>26,63</b>	AV200	<b>25,05</b>	AV200T	<b>42,14</b>	AV100-60	<b>26,40</b>
10,00	2,0	5,0	6,00	45	AV101	<b>18,17</b>	AV101T	<b>27,85</b>	AV201	<b>25,87</b>	AV201T	<b>42,14</b>	AV101-60	<b>32,98</b>
14,00	6,0	13,0	8,00	50	AV102	<b>22,70</b>	AV102T	<b>39,15</b>	AV202	<b>30,13</b>	AV202T	<b>52,54</b>	AV102-60	<b>40,04</b>
20,00	8,0	18,0	10,00	65	AV103	<b>40,64</b>	AV103T	<b>70,00</b>	AV203	<b>53,86</b>	AV203T	<b>88,93</b>	AV103-60	<b>45,67</b>
27,00	11,0	25,0	12,00	85	AV104	<b>72,64</b>	AV104T	<b>115,07</b>	AV204	<b>87,76</b>	AV204T	<b>140,10</b>	AV104-60	<b>79,57</b>
30,00	12,0	28,0	15,00	95	AV105	<b>122,59</b>	AV105T	<b>218,37</b>	AV205	<b>139,43</b>	AV205T	<b>240,73</b>	AV105-60	<b>130,40</b>
35,00	14,0	33,0	15,00	100	AV106	<b>188,28</b>	AV106T	<b>299,01</b>	AV206	<b>233,61</b>	AV206T	<b>404,84</b>	AV106-60	<b>206,65</b>
40,00	16,0	38,0	15,00	110	AV107	<b>259,96</b>	AV107T	<b>424,96</b>	AV207	<b>268,79</b>	AV207T	<b>433,74</b>	AV107-60	<b>280,07</b>
45,00	18,0	42,0	15,00	120	AV108	<b>344,44</b>	AV108T	<b>516,12</b>	AV208	<b>403,95</b>	AV208T	<b>575,41</b>	AV108-60	<b>361,96</b>
50,00	20,0	48,0	15,00	130	AV109	<b>415,59</b>	AV109T	<b>600,06</b>	AV209	<b>538,38</b>	AV209T	<b>722,42</b>	AV109-60	<b>441,04</b>

**AVELLANADOR CÓNICO 90° MULTILABIO**

Ref. FC

**TiAIN** **MD**

D1 mm	D2 mm	L mm	L2 mm	D3 mm	Z	FC	€
0,5	0,1	39,0	3,0	3,0	3	FC0050	<b>65,87</b>
0,6	0,1	39,0	3,0	3,0	3	FC0060	<b>65,87</b>
0,7	0,1	39,0	3,0	3,0	3	FC0070	<b>65,87</b>
0,8	0,1	39,0	3,0	3,0	3	FC0080	<b>65,87</b>
0,9	0,1	39,0	3,0	3,0	3	FC0090	<b>65,87</b>
1,0	0,1	39,0	3,0	3,0	3	FC0100	<b>63,59</b>
1,5	0,1	39,0	4,5	3,0	3	FC0150	<b>63,59</b>
2,0	0,1	39,0	6,0	3,0	3	FC0200	<b>63,59</b>
2,5	0,1	39,0	7,5	3,0	3	FC0250	<b>63,59</b>
3,0	0,1	39,0	-	3,0	3	FC0300	<b>63,59</b>
4,0	0,8	54,0	-	4,0	4	FC0400	<b>65,87</b>
6,0	0,8	57,0	-	6,0*	4	FC0600	<b>69,27</b>
8,0	0,8	63,0	-	8,0*	5	FC0800	<b>76,09</b>
10,00	1,0	72,0	-	10,0*	6	FC1000	<b>90,85</b>
12,00	1,2	83,0	-	12,0*	6	FC1200	<b>134,00</b>
16,00	1,6	92,0	-	16,0*	6	FC1600	<b>239,61</b>
20,00	2,0	104,0	-	20,0*	6	FC2000	<b>438,33</b>

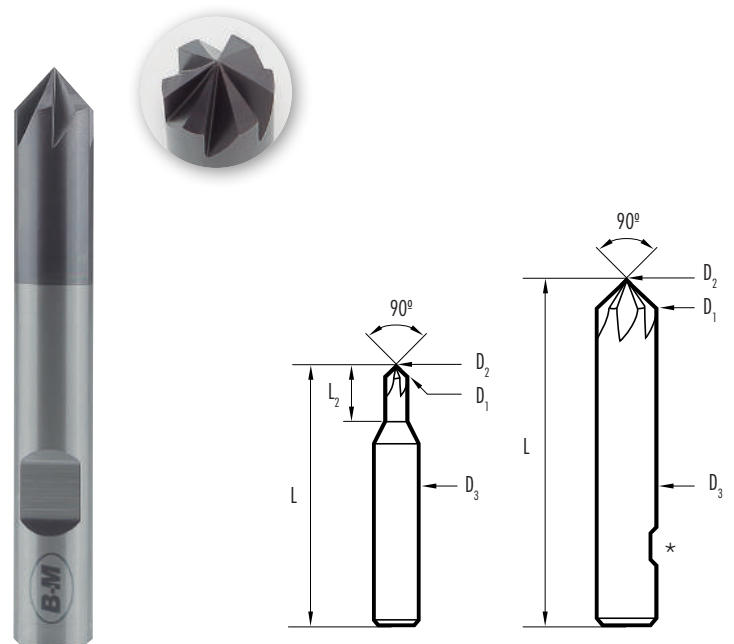

\*Con plano de arrastre

## AVELLANADORES CON MANGO CÓNICO

3Z

Ref. AV17

DIN  
335D

HSS



90°

Ref. AV17MD

DIN  
335D

MD



90°

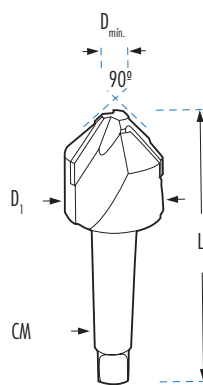
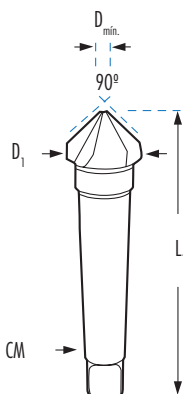

AV17

D1 mm	D mín. mm	L1 mm	CM	€
16,50	4,0	90	1	86,57
20,50	3,5	100	2	102,06
25,00	3,8	106	2	103,11
31,00	4,2	112	2	114,77
40,00	10,0	140	3	176,62
50,00	14,0	150	3	222,34
63,00	16,0	180	4	359,49
80,00	22,0	190	4	615,10
100,00	25,0	210	4	1.585,27

AV17MD

D1 mm	D mín. mm	L1 mm	CM	€
63,00	16,0	190	4	1.504,61 *
80,00	22,0	190	4	1.836,84 *

\*Hasta fin de existencias

## AVELLANADORES MULTICORTE CON MANGO CÓNICO

MULTI  
CORTE

Ref. AV23

DIN  
334B

60°

Ref. AV18

DIN  
335B

90°

Ref. AV24

DIN  
347B

120°

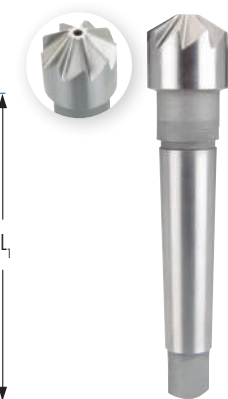
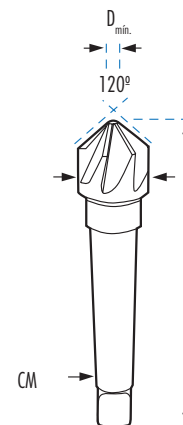
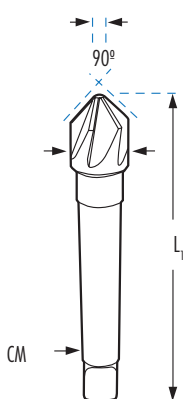
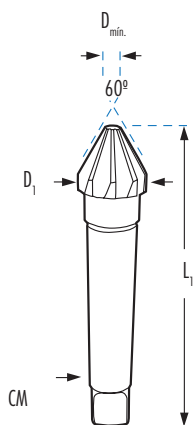

AV23

D1 mm	D mín. mm	L1 mm	CM	Z	HSS	€
16,00	3,2	93	1	7		65,68
20,00	4,0	116	2	7		76,89
25,00	7,0	121	2	9		84,22
31,50	9,0	124	2	9		115,16
40,00	12,5	150	3	11		210,77
50,00	16,0	153	3	13		251,95
63,00	20,0	185	4	15		385,70
80,00	25,0	196	4	17		596,10

AV18

D1 mm	D mín. mm	L1 mm	CM	Z	HSS	€
16,00	3,2	93	1	7		66,99
20,00	4,0	116	2	7		78,34
25,00	7,0	121	2	9		85,91
31,50	9,0	124	2	9		117,50
40,00	12,5	150	3	11		215,03
50,00	16,0	153	3	13		256,92
63,00	20,0	185	4	15		368,86
80,00	25,0	196	4	17		608,07
100,00	22,0	190	4	20		1.639,13

AV24

D1 mm	D mín. mm	L1 mm	CM	Z	HSS	€
16,00	3,2	93	1	7		68,22
20,00	4,0	116	2	7		79,84
25,00	7,0	121	2	9		91,69
31,50	9,0	124	2	9		119,61
40,00	12,5	150	3	11		190,46
50,00	16,0	153	3	13		246,01
63,00	20,0	185	4	15		400,53
80,00	25,0	196	4	17		619,03
100,00	27,0	210	4	3		1.624,65

**AVELLANADORES DE 1 CANAL**

**HSS**

**MANGO CILÍNDRICO**  
Ref. AV27  
Ref. AV29



**HSS**

**MANGO CÓNICO**  
Ref. AV34  
Ref. AV28

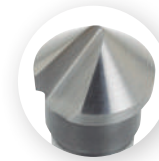

**1Z**

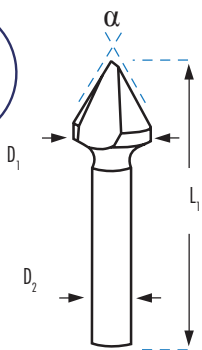

**1Z**

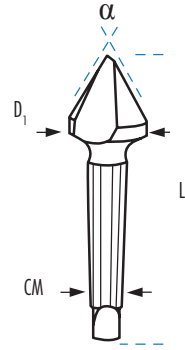





**AV27**

**AV29**

**AV34**

**AV28**

	D1 mm	D2 mm	L1 mm		
				€	€
AV270600	6,0	5,0	45	<b>14,18</b>	AV290600 <b>26,16</b>
AV270800	8,0	6,0	46	<b>14,98</b>	AV290800 <b>27,40</b>
AV271000	10,0	8,0	46	<b>15,87</b>	AV291000 <b>28,69</b>
AV271200	12,0	8,0	46	<b>18,48</b>	AV291200 <b>32,23</b>
AV271600	16,0	8,0	46,5	<b>22,01</b>	AV291600 <b>39,24</b>
AV272000	20,0	10,0	47	<b>30,08</b>	AV292000 <b>50,44</b>
AV272500	25,0	10,0	51	<b>39,62</b>	AV292500 <b>79,42</b>
AV273000	30,0	12,0	71	<b>57,15</b>	AV293000 <b>103,72</b>
AV274000	40,0	13,0	89	<b>148,93</b>	AV294000 <b>180,29</b>
AV275000	50,0	13,0	98	<b>183,87</b>	AV295000 <b>269,35</b>

	D1 mm	CM	L1 mm		
				€	€
AV341600	16,0	1	92	<b>68,19</b>	AV281600 <b>65,24</b>
AV342000	20,0	2	107	<b>85,46</b>	AV282000 <b>71,47</b>
AV342500	25,0	2	110	<b>110,05</b>	AV282500 <b>105,97</b>
AV343000	30,0	2	114	<b>125,05</b>	AV283000 <b>139,64</b>
AV344000	40,0	3	145	<b>201,21</b>	AV284000 <b>183,86</b>
AV345000	50,0	3	152	<b>293,81</b>	AV285000 <b>279,21</b>

## AVELLANADORES EXTERNOS DE 3 CORTES

3Z

Ref. AVX

HSS



90°

Ref. AVX-60

HSS



60°

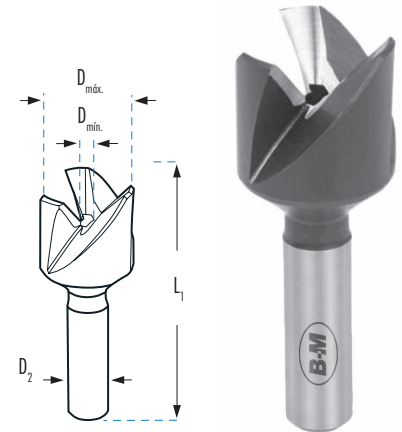

AVX					
Dmáx. mm	Dmín. mm	D2 mm	L1 mm		€
12,00	4,0	8,0	55	AVX1	59,35
20,00	8,0	10,0	60	AVX2	110,56
28,00	10,0	13,0	70	AVX3	156,84
40,00	12,0	CM2	125	AVX4	238,00
50,00	15,0	CM3	130	AVX5	332,51

AVX-60					
Dmáx. mm	Dmín. mm	D2 mm	L1 mm		€
8,00	3,0	8,0	55	AVX1-60	63,40
15,00	6,0	10,0	60	AVX2-60	121,66
28,00	10,0	13,0	75	AVX3-60	182,33

## AVELLANADOR EXTERNO PARA REPARACIÓN DE HILOS DE ENTRADA

Ref. AVEXT

HSS



60°



Min.-Max.		L1 mm		€
M8-M18	1/4"	75	AVEXT	28,11



## AVELLANADOR EXTERNO DE METAL DURO PARA REPARACIÓN DE HILOS DE ENTRADA

NEW

Ref. AVMDEXT

MD



60°

INOX



Min.-Max.			€
5-25 mm	1/4"	AVMDEXT	32,36

**AVELLANADORES PARA ASIENTOS DE TORNILLOS «ALLEN»**

**MANGO CILÍNDRICO**

Ref. AV2

**DIN 373**

**HSS**

NOTA: La longitud de corte se entiende sin la guía.

\* El ajuste grueso se utiliza para avellanar agujeros roscados.

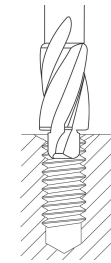
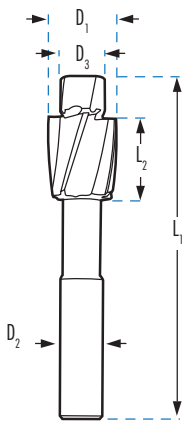

Para avellanar Orificios roscados



**AV2M**

**AV2MM**

**AV2GM**

AJUSTE	D1 mm	D2 mm	L1 mm	L2 mm		D3 mm	FINO	D3 mm	MEDIO	D3 mm	AGUJERO ROSCADO		
							€		€		€		
M3	6,0	5,0	71	14	AV2M3	3,2	25,59	AV2MM3	3,4	27,70	AV2GM3	2,5	27,70
M4	8,0	5,0	71	14	AV2M4	4,3	25,59	AV2MM4	4,5	27,70	AV2GM4	3,3	27,70
M5	10,0	8,0	80	18	AV2M5	5,3	25,59	AV2MM5	5,5	27,70	AV2GM5	4,2	27,70
M6	11,0	8,0	80	18	AV2M6	6,4	28,84	AV2MM6	6,6	31,22	AV2GM6	5,0	31,22
M7	20,0	12,7	90	20	AV2M7	7,4	53,25						
M8	15,0	12,5	100	22	AV2M8	8,4	35,75	AV2MM8	9,0	38,70	AV2GM8	6,8	38,70
M10	18,0	12,5	100	22	AV2M10	10,5	42,56	AV2MM10	11,0	46,07	AV2GM10	8,5	46,07
M11	22,0	18,8	100	22	AV2M11	11,5	56,65						
M12	20,0	12,5	100	22	AV2M12	13,0	49,65	AV2MM12	14,0	53,75	AV2GM12	10,2	53,75
M14	24,0	12,5	100	22	AV2M14	15,0	77,66	AV2MM14	15,5	84,07	AV2GM14	12,0	84,07
M16	26,0	12,5	100	22	AV2M16	17,0	85,42	AV2MM16	17,5	92,46	AV2GM16	14,0	92,46

**CABEZA CÓNICA CON GUÍA**

Ref. AV3

**DIN 1866**

**HSS**

NOTA: La longitud de corte se entiende sin la guía.

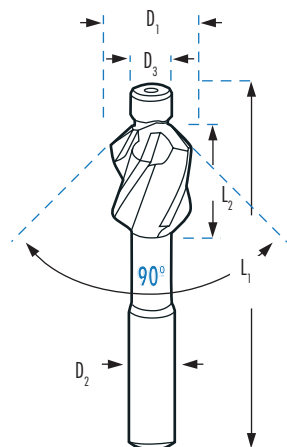

AJUSTE	D1 mm	D2 mm	L1 mm	L2 mm		D3 mm	FINO
							€
M3	6,3	6,0	71	14,0	AV3M3	3,2	35,00
M4	8,3	8,0	71	14,0	AV3M4	4,3	35,00
M5	10,4	10,0	80	18,0	AV3M5	5,3	35,00
M6	12,4	10,0	80	18,0	AV3M6	6,4	39,77
M8	16,5	12,0	100	22,0	AV3M8	8,4	48,67
M10	20,5	12,0	100	22,0	AV3M10	10,5	52,65
M12	24,5	13,0	110	25,0	AV3M12	13,0	64,18

## AVELLANADORES PARA ASIENTOS DE TORNILLOS «ALLEN»

MANGO CÓNICO

DIN  
375

HSS

Ref. AV5

NOTA: La longitud de corte se entiende sin la guía.

\* El ajuste grueso se utiliza para avellanar agujeros roscados.

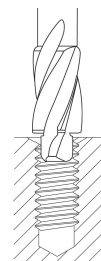
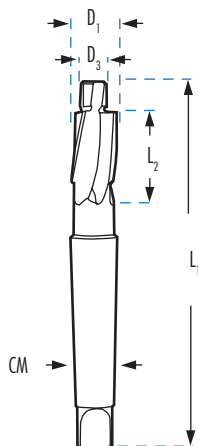
PARA AVELLANAR  
ORIFICIOS ROSCADOS

AJUSTE	D1 mm	CM	L1 mm	L2 mm		AV5M		AV5MM		AV5GM			
						D3 mm	FINO €	D3 mm	MEDIO €	D3 mm	AGUJERO ROSCADO €		
M8	15,0	2	132	22	AV5M8	8,4	69,29			AV5GM8	6,8	69,29	
M10	18,0	2	140	25	AV5M10	10,5	71,11	AV5MM10	11,0	71,11	AV5GM10	8,5	71,11
M12	20,0	2	140	25	AV5M12	13,0	78,68	AV5MM12	14,0	78,68	AV5GM12	10,2	78,68
M14	24,0	2	150	30	AV5M14	15,0	109,21	AV5MM14	15,5	109,21	AV5GM14	12,0	109,21
M16	26,0	3	180	35	AV5M16	17,0	128,25	AV5MM16	17,5	128,25	AV5GM16	14,0	128,25
M18	30,0	3	180	35	AV5M18	19,0	138,38	AV5MM18	20,0	138,38	AV5GM18	15,5	138,38
M20	33,0	3	190	40	AV5M20	21,0	150,77	AV5MM20	22,0	150,77	AV5GM20	17,5	150,77
M22	36,0	3	190	40	AV5M22	23,0	183,73	AV5MM22	24,0	183,73	AV5GM22	19,5	183,73
M24	40,0	3	190	40	AV5M24	25,0	222,11	AV5MM24	26,0	222,11	AV5GM24	21,0	222,11
M27	46,0	4	255	50	AV5M27	30,0	252,38						
M30	48,0	4	255	50	AV5M30	33,0	305,32						

## APLICACIONES DE LOS TIPOS DE AJUSTES: FINO, MEDIO Y AGUJERO ROSCADO

T<sub>1</sub>: Tornillos Cabeza Cilíndrica DIN 84 y DIN 7984  
Tornillos Autorroscantes DIN 7513

T<sub>2</sub>: Tornillos Cabeza Cilíndrica DIN 6912

T<sub>3</sub>: Tornillos Cabeza Cilíndrica DIN 912

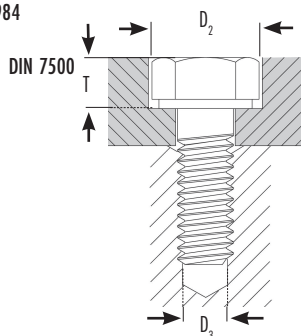

	FINO	MEDIO	AGUJERO ROSCADO				
ROSCAS MÉTRICAS	D3 mm	D3 mm	D3 mm	D2 mm	T1 mm	T2 mm	T3 mm
M3	3,2	3,4	2,5	6,0	2,4	--	3,4
M4	4,3	4,5	3,3	8,0	3,2	3,4	4,6
M5	5,3	5,5	4,2	10,0	4,0	4,2	5,7
M6	6,4	6,6	5,0	11,0	4,7	4,8	6,8
M8	8,4	9,0	6,8	15,0	6,0	6,0	6,0
M10	10,5	11,0	8,5	18,0	7,0	7,5	11,0
M12	13,0	13,5	10,2	20,0	8,0	8,5	13,0
M14	15,0	15,5	12,0	24,0	9,0	9,5	15,0
M16	17,0	17,5	14,0	26,0	10,5	11,5	17,5
M18	19,0	20,0	15,5	30,0	11,5	12,5	19,5
M20	21,0	22,0	17,5	33,0	12,5	13,5	21,5
M22	23,0	24,0	19,5	36,0	13,5	14,5	23,5

## AVELLANADORES CON ELEMENTOS INTERCAMBIABLES PARA ASIENTOS DE TORNILLOS CON CABEZA "ALLEN" Y CÓNICA

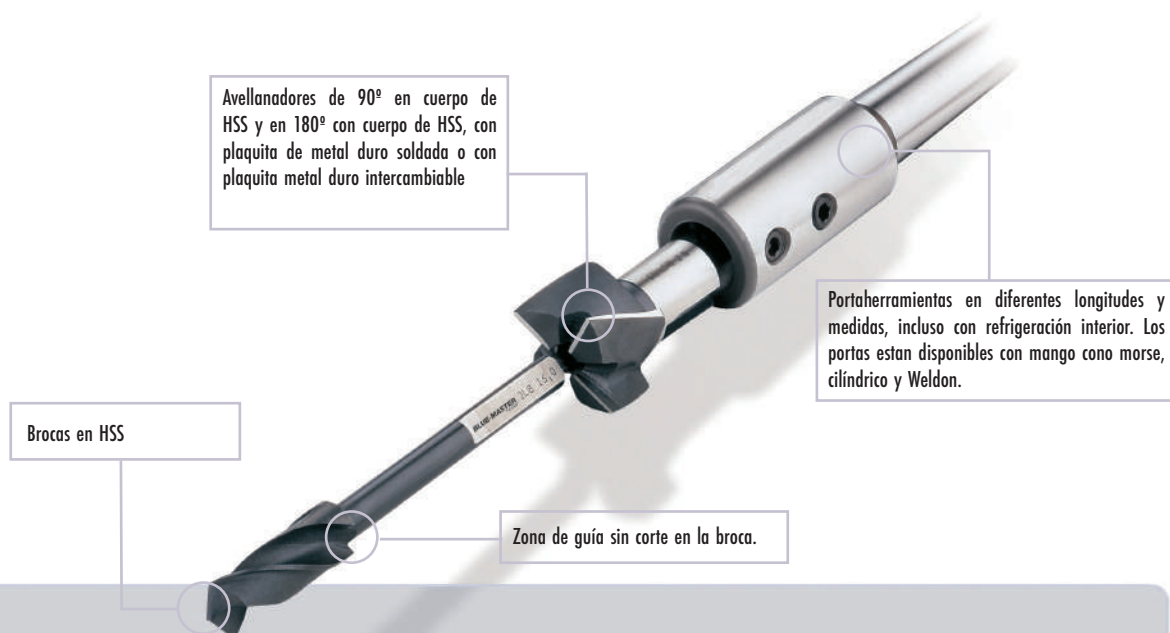

### EL SISTEMA BLUEMASTER

El sistema BLUEMASTER es único para operaciones de cajeado y avellanado, ayudándole a incrementar su productividad y disminuir sus costes.

Nuestros portaherramientas, fresas, brocas y guías pueden combinarse para adaptarlos a todo tipo de máquinas y aplicaciones.

Usted puede componer fácilmente más de 1.500.000 de herramientas especiales con sólo 1.300 piezas.

El sistema consta de 3 grupos de dimensiones: **SERIE A**, **SERIE B** y **SERIE C**.

Todas las combinaciones tienen que hacerse con elementos que pertenezcan al mismo grupo. Herramientas de distintos grupos no son combinables entre sí.

En las siguientes páginas encontrará tanto los rangos de medidas disponibles en cada grupo, así como recomendaciones para la correcta elección tanto de la herramienta como de los datos de corte.

**Importante!**

- \* Usando corte de metal duro colocar el tornillo de ajuste axial en contacto con la guía o broca insertada.
- \* Dejar un espacio entre el filo y la guía o broca para prevenir roturas por impacto accidental.
- \* El tornillo axial también se usa para prolongar la vida de las brocas tras reafilárselas.

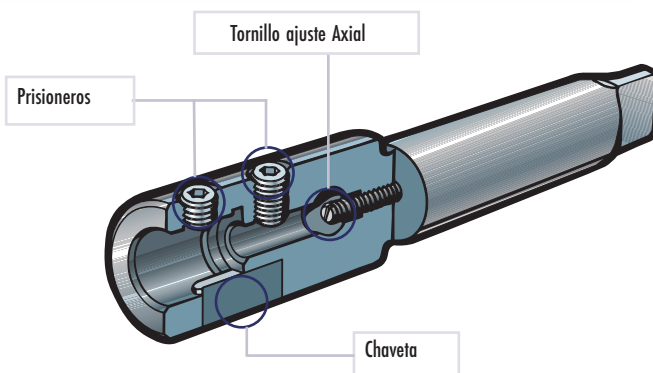

### DIMENSIONES DE GUÍA, PORTA Y BROCA

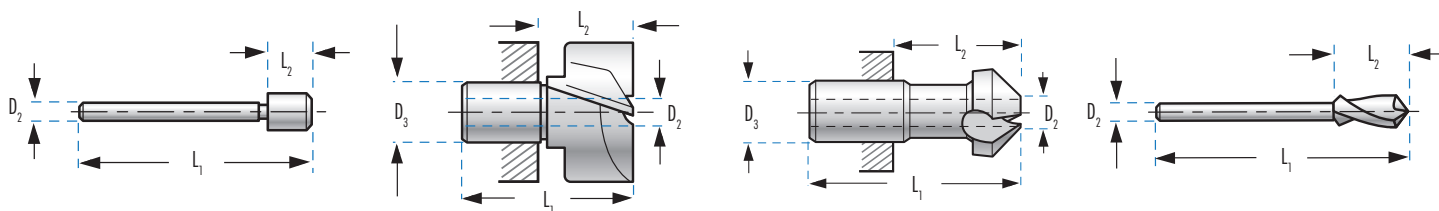

GUÍA				PORTAS				AVELLANADOR				BROCA					
	D2 mm	L1 mm	L2 mm	D3 mm	D2 mm	L1 mm	L2 mm	D3 mm	D2 mm	L1 mm	L2 mm	D2 mm	L1 mm	L2 mm			
<b>AGP</b>	4	64	9	<b>APAV-MD-PQ</b>	10	4	40	22	<b>AVC</b>	10	4	40	22	<b>ABP</b>	4	70	15
<b>BGP</b>	6	80	14	<b>BPAV-MD-PQ</b>	14	6	48	28	<b>BVC</b>	14	6	48	28	<b>BBP</b>	6	95	25
<b>CGP</b>	10	110	20	<b>CPAV-MD-PQ</b>	22	10	61	33	<b>CVC</b>	22	10	61	33	<b>CBP</b>	10	125	30

## AVELLANADORES CON ELEMENTOS INTERCAMBIABLES PARA ASIENTOS DE TORNILLOS CON CABEZA "ALLEN" Y CÓNICA

### SERIE A

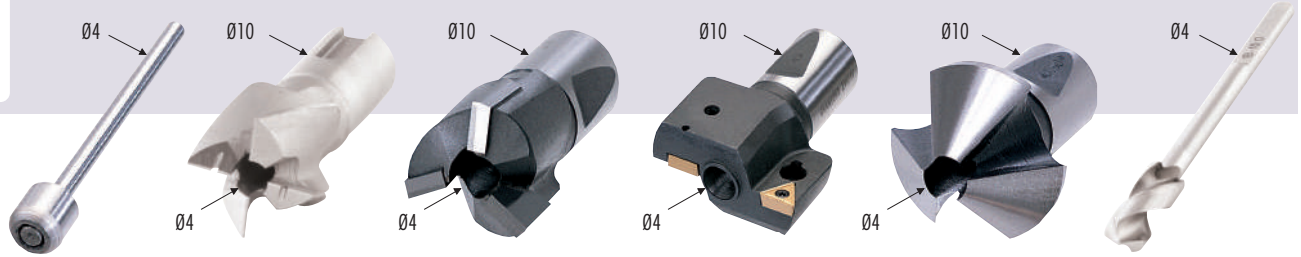

GUÍA

PORTA

PORTA

PLAQUITA INTERCAMBIABLE

AVELLANADOR

BROCA

AGP

APAV

APAVMD

APAVPQ

AVC

ABP

HSS

MD

Plaquita no incluida

PMD



HSS

HSS

€

€

€

€

€

€

AGP	APAV	APAVMD	APAVPQ	AVC	ABP
€	HSS €	MD €	Plaquita no incluida PMD €	90° HSS €	HSS €
					ABP0430 <b>80,83</b>
					ABP0450 <b>80,83</b>
					ABP0500 <b>80,83</b>
					ABP0530 <b>80,83</b>
					ABP0550 <b>80,83</b>
				AVC0800 <b>185,52</b>	ABP0600 <b>95,01</b>
					ABP0640 <b>95,01</b>
AGP0400 <b>46,64</b>				AVC1000 <b>185,52</b>	ABP0650 <b>95,01</b>
AGP0450 <b>55,62</b>					
AGP0550 <b>55,62</b>	APAV0700 <b>142,35</b>				
AGP0600 <b>55,62</b>	APAV0800 <b>140,63</b>				
AGP0650 <b>55,62</b>	APAV0900 <b>140,63</b>				
AGP0650 <b>55,62</b>	APAV1000 <b>136,12</b>	APAVMD1000 <b>399,78</b>		AVC1000 <b>185,52</b>	ABP0650 <b>95,01</b>
AGP0640 <b>55,62</b>					
AGP0660 <b>55,62</b>	APAV1100 <b>140,63</b>	APAVMD1100 <b>399,78</b>		AVC1200 <b>188,29</b>	ABP0660 <b>95,01</b>
AGP0500 <b>55,62</b>					
	APAV1150 <b>155,49</b>				ABP0700 <b>95,01</b>
	APAV1200 <b>142,35</b>	APAVMD1200 <b>399,78</b>		AVC1150 <b>182,08</b>	
	APAV1250 <b>157,90</b>			AVC1240 <b>190,48</b>	
	APAV1300 <b>155,15</b>	APAVMD1300 <b>399,78</b>			
	APAV1350 <b>178,63</b>			AVC1350 <b>190,48</b>	
	APAV1400 <b>155,15</b>	APAVMD1400 <b>403,56</b>		AVC1400 <b>204,20</b>	
	APAV1450 <b>178,98</b>				
AGP0840 <b>56,33</b>					
AGP0900 <b>56,33</b>	APAV1500 <b>156,87</b>	APAVMD1500 <b>408,06</b>		AVC1500 <b>205,91</b>	
AGP0680 <b>55,62</b>					
AGP0700 <b>55,62</b>	APAV1600 <b>165,83</b>	APAVMD1600 <b>417,40</b>		AVC1600 <b>206,96</b>	
AGP0750 <b>55,62</b>	APAV1700 <b>168,99</b>	APAVMD1700 <b>426,39</b>		AVC1650 <b>201,45</b>	
AGP0800 <b>56,33</b>	APAV1800 <b>173,43</b>	APAVMD1800 <b>435,34</b>	APAVPQ1800 <b>909,39</b>		
AGP0850 <b>56,33</b>	APAV1900 <b>184,52</b>	APAVMD1900 <b>455,03</b>			
AGP0900 <b>56,33</b>	APAV2000 <b>191,08</b>	APAVMD2000 <b>464,73</b>	APAVPQ2000 <b>1.019,28</b>		
AGP0950 <b>56,33</b>	APAV2100 <b>208,36</b>	APAVMD2100 <b>486,81</b>			
AGP1000 <b>56,33</b>					
AGP1050 <b>56,33</b>					
AGP1100 <b>56,33</b>					
AGP1150 <b>56,33</b>					

### ADAPTADORES



APH

	D1 mm	D2 mm	L1 mm	L2 mm	CM Ø mm	€
APHCM1	18	10	110	48	CM1	<b>333,41</b>
APHCM2	18	10	132	57	CM2	<b>327,20</b>
APH-T0	18	10	92	42	Ø10	<b>311,65</b>

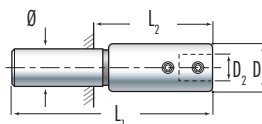
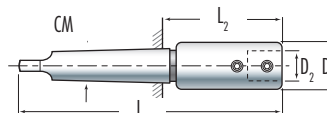

### PLAQUITAS DE REPUESTO

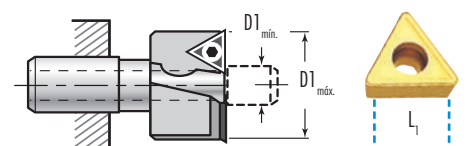

PPQ

	L1 mm	D1 mín. Ømm	D1 máx. Ømm	€
PPQ07	7	18	20	<b>34,56</b>

**AVELLANADORES CON ELEMENTOS INTERCAMBIABLES PARA ASIENTOS DE TORNILLOS CON CABEZA "ALLEN" Y CÓNICA**

Avellanadores

Rosa

**SERIE B**

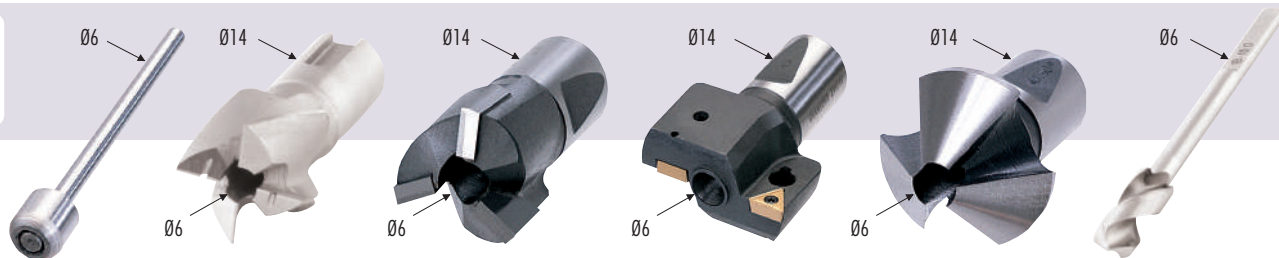

GUÍA		PORTA		PORTA		PLAQUITA INTERCAMBIABLE		AVELLANADOR		BROCA	
BGP		BPAV		BPAVMD		BPAVPQ		BVC		BBP	
€	HSS	€	MD	Plaquita no incluida	PMD	90°	HSS	€	HSS	€	
		BPAV1300	157,56	BPAVMD1300	426,39						
		BPAV1350	177,92								
		BPAV1400	157,56	BPAVMD1400	426,39						
		BPAV1450	177,92								BBP0800 112,99
BGP0840	52,52										
BGP0900	52,52	BPAV1500	157,56	BPAVMD1500	426,39			BVC15	195,57		BBP0900 112,99
BGP0680	52,52										
BGP0800	52,52										
BGP1000	52,52	BPAV1550	180,35								
BGP1150	55,62	BPAV1600	166,21	BPAVMD1600	442,25						BBP0840 112,99
BGP1250	57,70	BPAV1650	192,79								BBP0850 112,99
BGP1350	63,57	BPAV1700	173,09	BPAVMD1700	442,25						BBP0950 112,99
BGP1450	64,25	BPAV1750	194,16								BBP1000 128,87
		BPAV1900	199,71	BPAVMD1900	446,08						BBP1050 128,87
BGP1050	55,62										
BGP1100	55,62	BPAV1800	179,67	BPAVMD1800	446,08						
BGP0850	52,52										
BGP1300	63,57										
BGP1400	64,25	BPAV2000	199,71	BPAVMD2000	459,88	BPAVPQ2000	910,15	BVC25	230,13		
BGP1020	55,62										
BGP1500	64,25										
BGP1550	64,25	BPAV2400	236,00	BPAVMD2400	488,57	BPAVPQ2400	911,32	BVC28	267,77		
BGP1200	55,62										
BGP1700	64,25										
BGP1750	64,25	BPAV2600	252,22	BPAVMD2600	491,33	BPAVPQ2600	1.044,89	BVC30	273,66		
BGP1400	64,25										
BGP1900	65,64										
BGP2000	81,89	BPAV3000	340,67	BPAVMD3000	535,91	BPAVPQ3000	1.044,89				
		BPAV3400	402,85	BPAVMD3400	618,08	BPAVPQ3400	1.206,05				

**ADAPTADORES**



BPH						
	D1 mm	D2 mm	L1 mm	L2 mm	CM Ømm	€
BPHCM1	24	14	123	62	CM1	369,72
BPHCM2	24	14	137	62	CM2	337,57
BPHCM3	24	14	160	66	CM3	369,72
BPH-12	24	14	120	55	Ø12	333,75

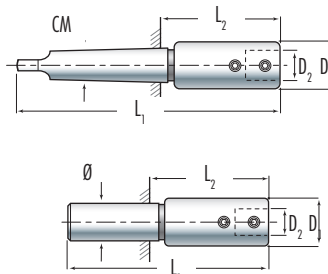

**PLAQUITAS DE REPUESTO**

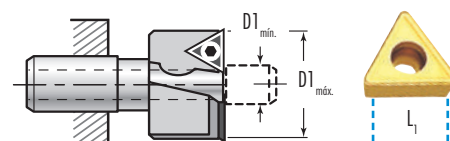

PPQ				
	L1 mm	D1 mín. Ømm	D1 máx. Ømm	€
PPQ07	7	20	25	34,56
PPQ10	10	26	33	31,11
PPQ12	12	34	36	31,11

## AVELLANADORES CON ELEMENTOS INTERCAMBIABLES PARA ASIENTOS DE TORNILLOS CON CABEZA "ALLEN" Y CÓNICA

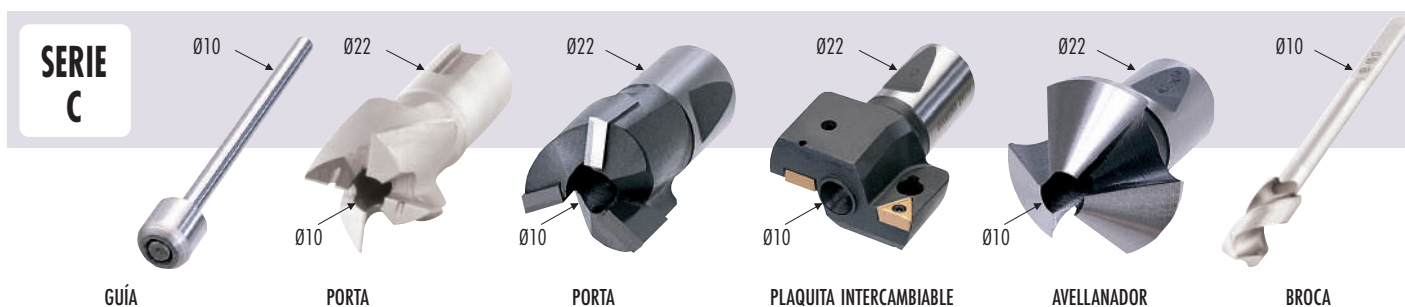

CGP		CPAV		CPAVMD		CPAVPQ		CVC		CBP	
€	HSS €	MD €	Plaquita no incluida	PMD €	90° HSS €	HSS €					
CGP1200	59,77	CPAV2300	286,08	CPAVMD2300	533,12						
CGP1250	59,77	CPAV2400	289,86	CPAVMD2400	527,59						
CGP1300	59,77	CPAV2500	313,40	CPAVMD2500	528,64						
CGP1350	59,77	CPAV2600	319,61	CPAVMD2600	543,15						
CGP1400	70,14	CPAV2700	324,09								
CGP1450	70,14	CPAV2800	330,31	CPAVMD2800	548,33					CBP1700	282,30
CGP1500	70,14	CPAV2900	338,25							CBP1800	318,21
CGP1600	70,14	CPAV3100	367,63							CBP1900	333,75
CGP1650	70,14	CPAV3200	379,72	CPAVMD3200	598,77					CBP2100	361,77
CGP1700	70,14	CPAV3300	383,16							CBP2300	435,34
CGP1900	70,14										
CGP2000	70,14	CPAV3000	342,73	CPAVMD3000	604,65			CVC35	399,06	CBP2000	361,77
CGP1550	70,14										
CGP2100	78,09										
CGP2200	78,09	CPAV3400	387,00	CPAVMD3400	642,66	CPAVPQ3400	1.247,19	CVC37	422,22	CBP2200	403,56
CGP1750	70,14										
CGP1850	70,14	CPAV3500	405,29								
CGP2300	78,09										
CGP2400	78,09	CPAV3600	410,14	CPAVMD3600	660,27	CPAVPQ3600	1.247,19	CVC37	422,22	CBP2400	444,70
CGP1950	70,14										
CGP2500	78,09										
CGP2600	96,04	CPAV4000	476,13	CPAVMD4000	731,44	CPAVPQ4000	1.275,92	CVC40	448,82		
CGP2100	78,09										
CGP2200	78,09	CPAV4500	587,38			CPAVPQ4500	1.299,22				
CGP2050	78,09	CPAV5000	853,08			CPAVPQ5000	1.520,17				
		CPAV5500	898,68			CPAVPQ5500	1.795,45				
		CPAV6000	947,04			CPAVPQ6000	1.795,45				
		CPAV6500	1.065,23			CPAVPQ6500	2.053,27				

### ADAPTADORES



						CPH
	D1 mm	D2 mm	L1 mm	L2 mm	CM Ømm	€
CPHCM2	36	22	160	85	CM2	486,81
CPHCM3	36	22	180	87	CM3	459,88
CPHCM4	36	22	206	89	CM4	515,50
CPHCM5	36	22	240	91	CM5	1.134,34
CPH-12	36	22	140	71	Ø20	333,75

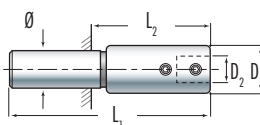
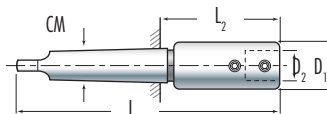

### PLAQUITAS DE REPUESTO

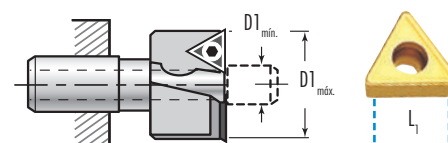

				PPQ
	L1 mm	D1 mín. Ømm	D1 máx. Ømm	€
PPQ12	12	34	45	31,11
PPQ17	17	<46		48,20

**ESTUCHES DE AVELLANADORES**

**ESTUCHES DE BROCAS AVELLANADORAS PARA TUBO Y CHAPA HSS Y HSSCO**

Avellanadores

Rosa



Ref. PAV6CM2



Ref. PAV40BM2313

**Metal Clásico**

- Caja metálica alta resistencia

**M**



Ref. AV40BM234

Ref. AV6CM3

**Plástico Azul**

- Rígido, Robusto y Ligero
- Ventana transparente
- Plástico reforzado con goma antichoque

**P** Las Referencias que comienzan por "P" se suministran en estuche de plástico

AV40	Ref.	Uds.	CONTENIDO	HSS	TiN
				€	
	PAV40BM234	3	P AV40BM2 (4-12 mm) AV40BM3 (4-20 mm) AV40BM4 (4-30 mm)	192,40	290,24
	PAV40BM235	3	P AV40BM2 (4-12 mm) AV40BM3 (4-20 mm) AV40BM5 (6-38 mm)	309,18	427,57
	PAV40BM2313	3	P AV40BM2 (4-12 mm) AV40BM3 (4-20 mm) AV40BM13 (6-40 mm)	386,72	475,50
	AV40BM234	3	M AV40BM2 (4-12 mm) AV40BM3 (4-20 mm) AV40BM4 (4-30 mm)	192,40	290,24
	AV40BM22122	3	M AV40BM2 (4-12 mm) AV40BM21 (7+10-20mm) AV40BM22 (10+20-30mm)	268,09	416,01
AVC40				HSSCo	TiN
	AVC40BM234	3	M AVC40BM2 (4-12 mm) AVC40BM3 (4-20 mm) AVC40BM4 (4-30 mm)	227,65	371,75
AV42				HSSCo	TiN
	AV42BM234	3	M AV42BM2 (4-12 mm) AV42BM3 (4-20 mm) AV42BM4 (4-30 mm)	218,50	324,43
AV30				HSS	TiN
	AV30BM012	3	M AV30BM0 (3-14 mm) AV30BM1 (6-20 mm) AV30BM2 (16-30 mm)	118,93	205,33
AVC30				HSSCo	TiN
	AVC30BM012	3	M AVC30BM0 (3-14 mm) AVC30BM1 (6-20 mm) AVC30BM2 (16-30 mm)	171,33	241,36



AV40BM2 AV40BM3 AV40BM4 AV40BM5 AV40BM13

AVC40BM2 AVC40BM3 AVC40BM4



AV42BM2 AV42BM3 AV42BM4



AV30BM0 AV30BM1 AV30BM2

AVC30BM0 AVC30BM1 AVC30BM2

## ESTUCHES DE AVELLANADORES

Avelanadores

Rosa



AV16	Ref.	Uds.		CONTENIDO	€
HSS	AV16CM1	6	M	Ø 6 - 8 - 10 11,5 - 15 - 19 mm	229,08
	AV16CM2	6	M	Ø 6,3 - 8,3 - 10,4 12,4 - 16,5 - 20,5 mm	234,81
TiN	AV16CM3	7	M	Ø 6,3 - 8,3 - 10,4 12,4 - 16,5 - 20,5 - 25 mm	307,72



Ref. PAV6CM2

Ref. AV16CM3



AV6	Ref.	Uds.		CONTENIDO	€
HSS	AV6CM1	6	M	Ø 6 - 8 - 10 11,5 - 15 - 19 mm	145,16
	AV6CM2	6	M	Ø 6,3 - 8,3 - 10,4 12,4 - 16,5 - 20,5 mm	143,06
	AV6CM3	7	M	Ø 6,3 - 8,3 - 10,4 12,4 - 16,5 - 20,5 - 25 mm	196,11
	PAV6CM2	6	P	Ø 6,3 - 8,3 - 10,4 12,4 - 16,5 - 20,5 mm	143,06



AV7	Ref.	Uds.		CONTENIDO	€
HSSCo	AV7CM1	6	M	Ø 6 - 8 - 10 11,5 - 15 - 19 mm	173,41
	AV7CM2	6	M	Ø 6,3 - 8,3 - 10,4 12,4 - 16,5 - 20,5 mm	171,79
	AV7CM3	7	M	Ø 6,3 - 8,3 - 10,4 12,4 - 16,5 - 20,5 - 25 mm	237,12
	PAV7CM2	6	P	Ø 6,3 - 8,3 - 10,4 12,4 - 16,5 - 20,5 mm	171,79



AV66	Ref.	Uds.		CONTENIDO	€
HSSCo	PAV66CM2	6	P	Ø 6,3 - 8,3 - 10,4 12,4 - 16,5 - 20,5 mm	208,23

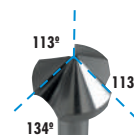

AV67	Ref.	Uds.		CONTENIDO	€
HSSCo	PAV67CM2	6	P	Ø 6,3 - 8,3 - 10,4 12,4 - 16,5 - 20,5 mm	270,70

HARDOX  
500

AV55	Ref.	Uds.		CONTENIDO	€
HSSCo	PAV55CM2	6	P	Ø 6,3 - 8,3 - 10,4 12,4 - 16,5 - 20,5 mm	270,70

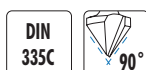

AV6MD	Ref.	Uds.		CONTENIDO	€
MD	PAV6MDCM2	6	P	Ø 6,3 - 8,3 - 10,4 12,4 - 16,5 - 20,5 mm	586,17

HARDOX  
500

AV55MD	Ref.	Uds.		CONTENIDO	€
MD	PAV55MDCM2	6	P	Ø 6,3 - 8,3 - 10,4 12,4 - 16,5 - 20,5 mm	818,08

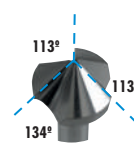

AV66MD	Ref.	Uds.		CONTENIDO	€
MD	PAV66MDCM2	6	P	Ø 6,3 - 8,3 - 10,4 12,4 - 16,5 - 20,5 mm	654,47

**ESTUCHES METÁLICOS DE AVELLANADORES**

Avellanadores

Rosa

DIN 334C

AV8	Ref.	Uds.		CONTENIDO	€
	AV8CM2	6	M	Ø 6,3 - 8 - 10 12,5 - 16 - 20 mm	217,46
HSS	AV8CM3	7	M	Ø 6,3 - 8,0 - 10 12,5 - 16 - 20 - 25 mm	281,14

NORMA CELESA

AV9	Ref.	Uds.		CONTENIDO	€
	AV9CM1	6	M	Ø 6,3 - 8,3 - 10,4 12,4 - 16,5 - 20,5 mm	222,42
HSS	AV9CM5	7	M	Ø 6,3 - 8,3 - 10,4 12,4 - 16,5 - 20,5 - 25 mm	287,82

\* Otros estuches bajo demanda AV99, etc.

90°

AV1	Ref.	Uds.		CONTENIDO	€
HSS	AV1S2	5	M	Ø 10 - 14 20 - 27 - 30 mm	314,70

\*Hasta fin de existencias

HSS DIN 373

AV2M	Ref.	Uds.		CONTENIDO	€
FINO	AV2M3-10	6	M	M3-M4-M5-M6-M8-M10	187,85
	AV2M3-12	7	M	M3-M4-M5-M6-M8-M10-M12	241,26

AV2MM	Ref.	Uds.		CONTENIDO	€
MEDIO	AV2M3-10M	6	M	M3-M4-M5-M6-M8-M10	203,37
	AV2M3-12M	7	M	M3-M4-M5-M6-M8-M10-M12	261,17

AV2GM	Ref.	Uds.		CONTENIDO	€
AGUJERO ROSCADO	AV2M3-10G	6	M	M3-M4-M5-M6-M8-M10	203,37
	AV2M3-12G	7	M	M3-M4-M5-M6-M8-M10-M12	261,17



AV8 AV9 AV10



Ref. AV10CM6

NORMA CELESA

AV10	Ref.	Uds.		CONTENIDO	€
	AV10CM1	6	M	Ø 6,3 - 8,3 - 10,4 12,4 - 16,5 - 20,5 mm	250,23
HSS	AV10CM6	7	M	Ø 6,3 - 8,3 - 10,4 12,4 - 16,5 - 20,5 - 25 mm	309,74



AV1



AV2 AV2MM AV2GM



Ref. AV2M3-10

## REBARBADORES DE PRECISI3N

## LOS REBARBADORES BLUEMASTER

Los rebarbadores BLUEMASTER se emplean para eliminar las virutas acumuladas en bordes y aristas de piezas fabricadas en metal, pl3stico o madera.

El sistema se completa ensamblando los tres componentes sealados: CUCHILLA + PORTACUCHILLAS + MANGO UNIVERSAL

El mango puede ser utilizado con todos los grupos de cuchillas, intercambiando oportunamente el portacuchillas para cada uno de ellos.

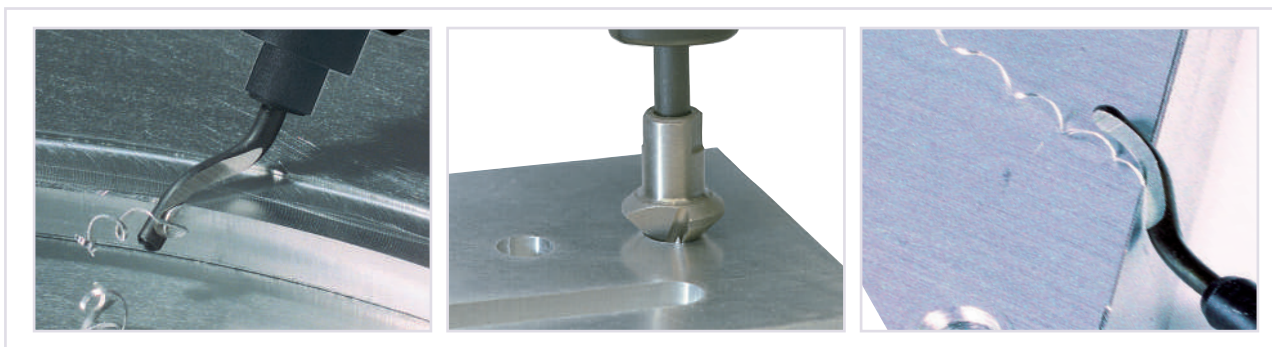
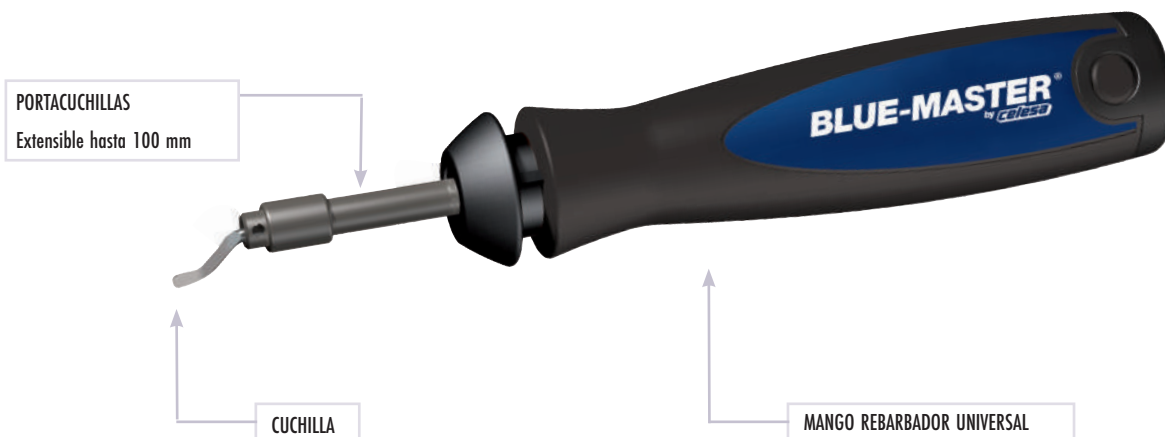

## CONJUNTO B

JRB1

Contenido B:

Ref. RB10



Ref. RBB1



Ref. RB20



Ref. RBB



Blister: 33,63 €

## CONJUNTO C

JRB2

Contenido C:

Ref. RC42

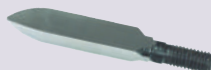

Ref. RBB1



Ref. RBC



Blister: 61,24 €

## CONJUNTO D

JRB3

Contenido D:

Ref. RD80MD



Ref. RBB1



Ref. RBD



Blister: 96,54 €

## CONJUNTO E

JRB4

Contenido E:

Ref. RE10



Ref. RBB1



Ref. RE20



Ref. RBE



Ref. RE30

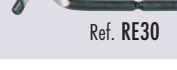

Blister: 37,45 €



**REBARBADORES DE PRECISIÓN**

**GRUPO B**

**PORTACUCHILLAS GRUPO B**

Ø2,6mm



Para cuchillas rebarbadoras Grupo B

**RBB**

**11,80 €**

**CUCHILLAS GRUPO B**



Cuchilla rebarbadora  
Serie corta: acero, aluminio, plástico

**RB10\***

Blister 10 U.: **2,18 €/U.**



Cuchilla punzonadora de Metal Duro

**RB50\***

Blister 1 U.: **38,85 €**



Cuchilla rebarbadora Bidireccional  
Serie corta: latón, fundición

**RB20**

Blister 10 U.: **2,18 €/U.**



Cuchilla rebarbadora para parte posterior de un taladro de hasta 20 mm de profundidad

**RB60\***

Blister 10 U.: **5,16 €/Ud**



Cuchilla rebarbadora doble arista agujeros de 4 mm de profundidad

**RB30**

Blister 10 U.: **2,18 €/U.**



Cuchilla rebarbadora de aristas exteriores

**RB70MD\***

Blister 1 U.: **44,20 €**

\*Hasta fin de existencia

**GRUPO C**

**PORTACUCHILLAS GRUPO C**



Para cuchillas rebarbadoras Grupo C

**RBC**

Blister 1 U.: **11,80 €**

**CUCHILLAS GRUPO C**



Cuchilla rasqueta ancho 4 x 20 mm

**RC40\***

Blister 1 U.: **24,06 €**



Cuchilla rasqueta ancho 8 x 30 mm

**RC42\***

Blister 1 U.: **29,93 €**

\*Hasta fin de existencia

**GRUPO D**

**PORTACUCHILLAS GRUPO D**



Para cuchillas rebarbadoras Grupo D

**RBD**

Blister 1 U.: **11,80 €**

**CUCHILLAS GRUPO D**



Cuchilla rebarbadora de metal duro en "V" Hembra cantos hasta 3 mm

**RD80MD\***

Blister 1 U.: **62,90 €**



Cuchilla rebarbadora de Metal Duro en "V" Hembra cantos hasta 8 mm

**RD82MD\***

Blister 1 U.: **98,61 €**

\*Hasta fin de existencia

## MANGO REBARBADOR UNIVERSAL

Usos generales.  
Válido para portacuchillas:  
Ref. RBB / RBC / RBD / RBE / RBF



RBB1

Blister 1 ud.: 15,51 €

## REBARBADORES DE PRECISIÓN

GRUPO  
E

## PORTACUCHILLAS GRUPO E



Para cuchillas rebarbadoras Grupo E

RBE

Blister 1 ud.: 11,80 €

## CUCHILLAS GRUPO E



Cuchilla rebarbadora  
para interiores y exteriores  
Serie larga: acero, aluminio, plástico

RE10

Blister 10 ud.: 2,67 €/Ud



Cuchilla rebarbadora  
para cantos rectos: chaveteros,...

RE35

Blister 10 ud.: 2,86 €/Ud



Cuchilla rebarbadora bidireccional  
Serie larga: latón, fundición

RE20

Blister 10 ud.: 2,67 €/Ud



Cuchilla rebarbadora  
cerrada doble arista para  
agujeros de 4 mm de profundidad

RE30

Blister 10 ud.: 2,67 €/Ud



Cuchilla rebarbadora para la parte  
posterior de un taladro de hasta  
20 mm de profundidad

RE60\*

Blister 5 ud.: 3,75 €/Ud

\*Hasta fin de existencia

GRUPO  
F

## PORTACUCHILLAS GRUPO F



Para cuchillas rebarbadoras Grupo F

RBF

Blister 1 ud.: 11,80 €

## CUCHILLAS GRUPO F (Rosca M05 x 0,80)



Cuchilla avellanadora HSS Ø 12 mm

RF12

Blister 1 ud.: 26,55 €

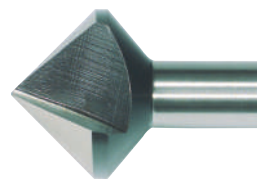

Cuchilla avellanadora HSS Ø 30 mm

RF30

Blister 1 ud.: 88,72 €



Cuchilla avellanadora HSS Ø 20 mm

RF20

Blister 1 ud.: 51,32 €