



BLUE-MASTER[®]
by *ce/esa*



PORTABROCAS

PORTABROCAS INDUSTRIALES PARA TALADROS DE COLUMNA O CNC

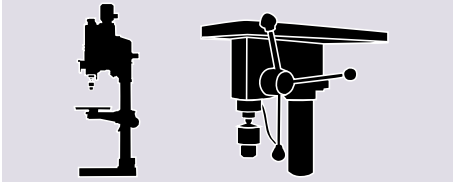

PREC.
<0,05

Ref. DC1

ALTA PRECISI3N

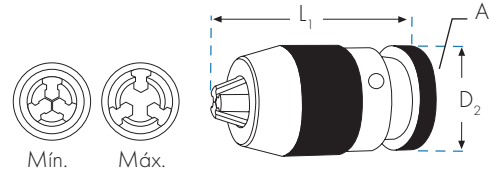

DC1						
	PRECISI3N mm	M3n.-M3x. mm	A	D2 mm	L1 mm	€
DC1-20-B22	<0,05	5-20	B22	58	130	206,12

PREC.
<0,20

Ref. DC3

INDUSTRIAL LIGERO

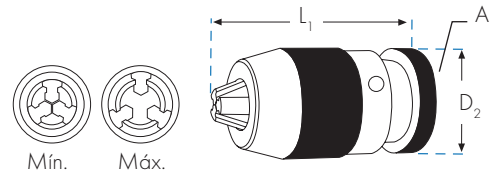

DC3						
	PRECISI3N mm	M3n.-M3x. mm	A	D2 mm	L1 mm	€
DC3-13-B16	<0,20	1-13	B16	43	94	81,90
DC3-13-3/8	<0,20	1-13	3/8-24 UNF	43	94	81,90
DC3-13-1/2	<0,20	1-13	1/2-20 UNF	43	94	81,90
DC3-16-B16	<0,20	1-16	B16	48	119	127,11
DC3-16-B18	<0,20	1-16	B18	48	119	127,11

PORTABROCAS INDUSTRIALES CON MANGO CÓNICO PARA TALADROS DE COLUMNA O CNC

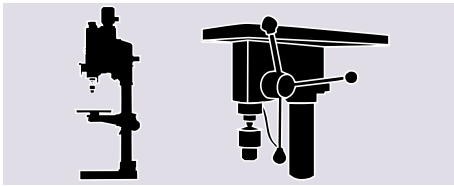

PREC. <0,05 Ref. DC10 **ALTA PRECISIÓN**

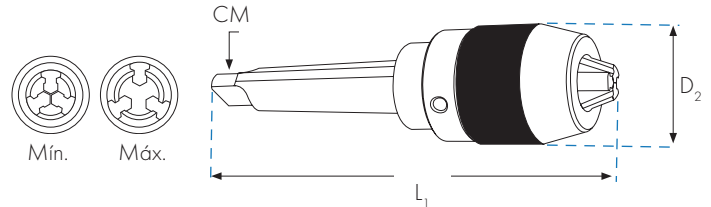

DC10						
	PRECISIÓN mm	Mín.-Máx. mm	CM	D ₂ mm	L ₁ mm	€
DC10-13-CM3	<0,05	1-13	CM3	51	192	264,23
DC10-13-CM4	<0,05	1-13	CM4	51	218	266,79
DC10-16-CM3	<0,05	1-16	CM3	56	207	270,16

PREC. <0,12 Ref. DC11 **INDUSTRIAL**

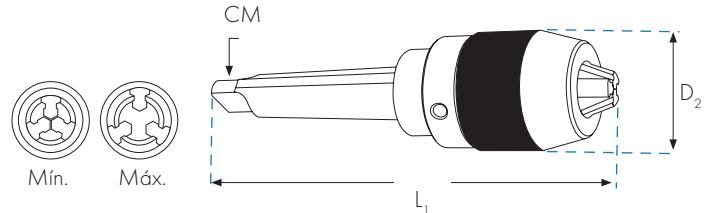

DC11						
	PRECISIÓN mm	Mín.-Máx. mm	CM	D ₂ mm	L ₁ mm	€
DC11-13-CM2	<0,12	1-13	CM2	51	174	159,55
DC11-13-CM3	<0,12	1-13	CM3	51	192	159,55
DC11-13-CM4	<0,12	1-13	CM4	51	218	159,55
DC11-16-CM3	<0,12	1-16	CM3	56	207	187,07

LLAVE DE PIVOTE PARA PORTABROCAS DC11



NEW

DC20				
	Mín.-Máx. mm	D ₂ mm	L ₁ mm	€
DC20-1	1-13	4-5	180	11,59
DC20-2	1-16	4-5	190	13,65

PORTABROCAS AUTOMÁTICOS PROFESIONALES

<950W

Ref. DC4



- Bloqueo automático.
- Cuerpo de plástico.
- Taladro tanto en modo rotación como en percusión.

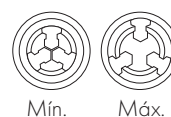

Mín.

Máx.

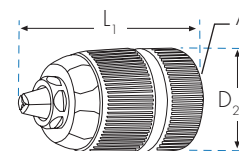

DC4

	W	Mín.-Máx. mm	A	D2 mm	L1 mm	€
DC4-13-1/2	<950	1,5-13	1/2-20 UNF	43	75	37,98
DC4-13-1/2-SDS	<950	1,5-13	1/2-20 UNF	43	75	43,81

Ref. DC4-13-1/2-SDS

<1050W

Ref. DC5



- Bloqueo automático.
- Cuerpo de metal.
- Alta potencia.
- Garras especiales para alto rendimiento.
- Taladro tanto en modo rotación como en percusión.

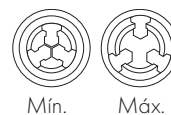

Mín.

Máx.

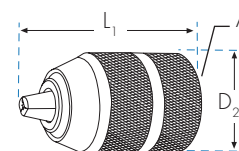

DC5

	W	Mín.-Máx. mm	A	D2 mm	L1 mm	€
DC5-13-1/2	<1050	1,5-13	1/2-20 UNF	43	75	50,09
DC5-13-SDS	<1050	1,5-13	1/2-20 UNF	43	75	57,86

Ref. DC5-13-SDS

<950W

Ref. DC13



- Se bloquea girando el taladro y presionando el portabrocas ligeramente con la mano.
- Pensado para taladros ligeros de batería.
- Cuerpo de plástico.



DC13

	W	Mín.-Máx. mm	A	D2 mm	L1 mm	€
DC13-10-1/2	<950W	0,8-10	1/2-20 UNF	40	65	12,75

Ref. DC13-10-1/2

PORTABROCAS DE LLAVE PROFESIONALES



Ref. DC6

- Admite percusión, se recomienda uso en modo rotación.
- Incluye llave

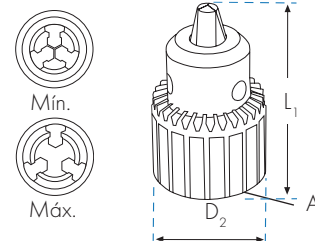

	Min.-Máx. mm	A	D2 mm	L1 mm	DC6 €
DC6-06-B10	0,5-6,5	B10	31	50	38,09
DC6-06-3/8	0,5-6,5	3/8-24 UNF	31	50	38,09
DC6-10-1/2	1-10	1/2-20 UNF	37	60	29,83
DC6-13-B12	1-13	B12	46	78	39,01
DC6-13-3/8	1-13	3/8-24 UNF	46	78	39,01
DC6-16-B16	1-16	B16	57	95	43,60
DC6-19-B22	5-20	B22	68	115	59,66

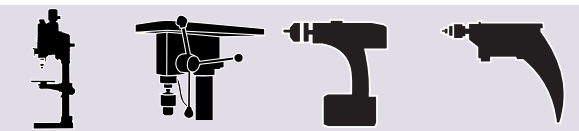

Ref. DC7

LIGERO

- Taladro tanto en modo percusión como en rotación.
- Incluye llave

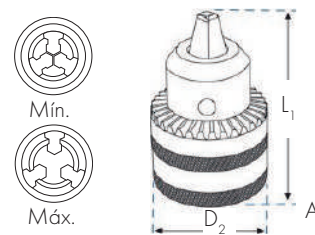

Ref. DC7-13-SDS

	Min.-Máx. mm	A	D2 mm	L1 mm	DC7 €
DC7-06-B10	0,6-6,5	B10	30	50	16,36
DC7-06-3/8	0,6-6,5	3/8-24 UNF	30	50	16,36
DC7-10-1/2	1,5-10	1/2-20 UNF	33	59	15,00
DC7-13-B12	1,5-13	B12	42	70	19,00
DC7-13-B16	1,5-13	B16	42	70	19,00
DC7-13-3/8	1,5-13	3/8-24 UNF	42	70	19,00
DC7-13-1/2	1,5-13	1/2-20 UNF	42	70	19,00
DC7-13-SDS	1,5-13	1/2-20 UNF	42	70	19,99
DC7-16-1/2	3-16	1/2-20 UNF	51	87	24,00

PORTABROCAS CON ALARGADOR FLEXIBLE

Ref. DC15-001

- Alargador flexible de 1050 mm.
- Portabrocas automático de Ø1 a 6 mm de capacidad.
- Velocidad máxima de trabajo 6000 rpm.



DC15-001				
	Mín.-Máx. mm	D2 mm	L1 mm	€
DC15-001	1-6	30	1050	35,15

PORTABROCAS EN ÁNGULO

Ref. DC15-002

- Indicado para trabajar en lugares de difícil acceso.
- Uso exclusivo en modo rotación.
- Portabrocas automático de Ø 1 a 10 mm de capacidad.
- Diseño ligero. Incluye asa para uso por zurdos y diestros.



DC15-002				
	Mín.-Máx. mm	D2 mm	α	€
DC15-002	1-10	41	90°	20,58

MINI-PORTABROCAS MANGO HEX.



P29

- Mango 1/4 Hex.
- De 0,6 a 6,0 mm

18,48

SOPORTE DE COLUMNA PROFESIONAL PARA TALADRO

- Manilla con muelle de retracción (recupera la posición de forma rápida, sencilla y sin ningún esfuerzo).
- Regla de control de taladrado, 60 mm de profundidad.
- Soporte de columna profesional para taladro con Ø43/38 mm.
- Base de hierro fundido con guías para mordaza de sujeción y orificios para su anclaje a la mesa de trabajo.
- Taladrado preciso de superficie, piezas de trabajo redondas o listones.

Ref. STE99

**43/38
mm**

**60
mm**

**510
mm**

				STE99
	Ø Amarre mm	Profundidad Taladrado mm	Altura mm	€
STE99	43/38	60	510	66,74

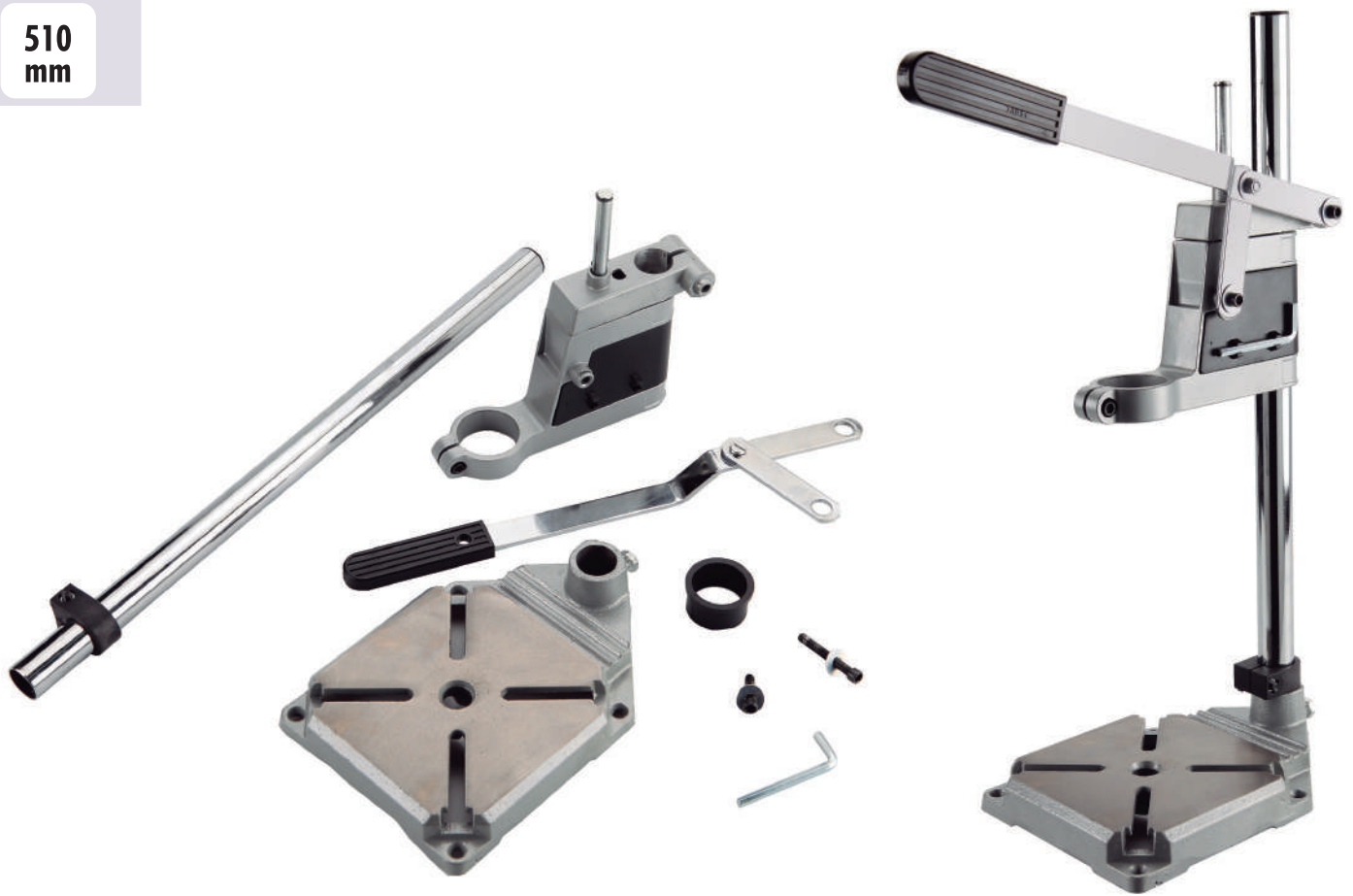

ACCESORIOS PARA BROCAS Y PORTABROCAS

LLAVES PARA PORTABROCAS



		DC	
	Mín.-Máx. mm	Ø mm	€
DC-10	1 - 10	6	4,43
DC-13	1 - 13	6	5,41
DC-16	1 - 16	8	6,73
DC-20	5 - 20	9	11,94



ADAPTADORES SDS PLUS



	Rosca (A)	DC
		€
DC -3/8	3/8 - 24 UNF	15,01
DC -1/2	1/2 - 20 UNF	15,01



ADAPTADOR 1/4" HEX.



	Mango	Rosca	DC-01
			€
DC-01	1/4" Hex.	3/8 - 24 UNF	8,68

CONOS REDUCTORES

DIN
2185

CONO MORSE		L1 mm	CR	
EXT.	INT.			€
1	0	80	24,13	
2	1	92	23,80	
3	1	99	32,51	
3	2	112	33,12	
4	1	124	50,05	
4	2	124	47,03	
4	3	140	47,03	

CONO MORSE		L1 mm	CR	
EXT.	INT.			€
5	1	156	86,15	
5	2	156	78,63	
5	3	156	78,63	
5	4	171	80,28	
6	3	218	150,61	
6	4	218	170,89	
6	5	218	170,89	

CONOS AUMENTADORES

DIN
2187

CONO MORSE		L1 mm	D1 mm	CA	
EXT.	INT.				€
1	2	160	30	49,99	
2	3	196	36	67,96	
3	4	240	48	114,61	
4	5	300	63	192,37	
5	6	415	80	540,64	

CONOS REDUCTORES ALARGADORES

DIN
2187

CONO MORSE		L1 mm	CA	
EXT.	INT.			€
2	1	160	33,63	
3	1	175	46,78	
3	2	194	50,49	
4	1	200	70,82	
4	2	215	69,23	
4	3	240	72,43	
5	1	232	172,05	

CONO MORSE		L1 mm	CA	
EXT.	INT.			€
5	2	247	156,42	
5	3	268	137,84	
5	4	300	155,80	
6	3	330	355,44	
6	4	355	355,44	
6	5	390	358,08	

CONOS ALARGADORES

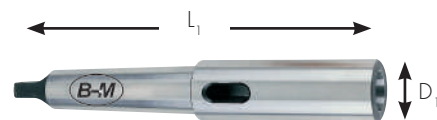

CONO MORSE		L1 mm	D1 mm	CA	
EXT.	INT.				€
1	1	145	20	32,71	
2	2	175	30	47,59	
3	3	215	36	72,08	
4	4	265	48	131,29	
5	5	335	63	247,32	
6	6	470	85	567,66	

ACCESORIOS PARA BROCAS Y PORTABROCAS

ESPIGAS DE SUJECIÓN CON MANGO CÓNICO PARA PORTABROCAS

EXTRACTOR PARA ESPIGAS DE SUJECIÓN DE PORTABROCAS CON CONO NORMALIZADO B16 Y B18

DIN 228	CONO MORSE	DIN 238	PORTA BROCAS
----------------	------------	----------------	--------------

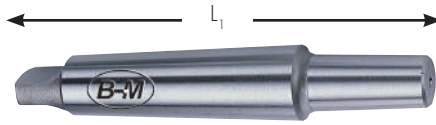

CM	PORTA BROCAS	L1 mm	€
1	B10	86	14,33
1	B12	89	10,76
1	B16	99	10,76
1	B18	107	12,34
2	B10	105	17,13
2	B12	106	13,08
2	B16	112	13,08
2	B18	119	13,08
2	B22	130	25,78
3	B12	127	19,69
3	B16	134	15,93
3	B18	140	15,93

CM	PORTA BROCAS	L1 mm	€
3	B22	147	26,82
3	B24	157	39,56
4	B16	158	23,96
4	B18	166	24,60
4	B22	176	44,24
4	B24	186	44,74
5	B16	193	86,77
5	B18	200	86,77
5	B22	208	90,51
5	B24	221	98,32
6	B22	240	184,89



CMEXT
48,16 €

CUÑA EXPULSADORA

ESPIGA DE SUJECIÓN MANGO CÓNICO PARA PORTABROCAS ROSCADOS



Nº	VÁLIDOS CM	L1 mm	€
0	0	90	14,32
1	1 / 2	140	16,92
3	3	190	22,34
4	4	225	30,40
5	5 / 6	265	49,36

	CM	A	€
CMR1-3/8	1	3/8-24h	21,14
CMR1-1/2	1	1/2-20h	21,14
CMR2-3/8	2	3/8-24h	21,14
CMR2-1/2	2	1/2-20h	21,14
CMR2-5/8	2	5/8-16h	21,14
CMR3-3/8	3	3/8-24h	28,60
CMR3-1/2	3	1/2-20h	28,60
CMR3-5/8	3	5/8-16h	28,60

ACCESORIOS PARA BROCAS

CONTRAPUNTOS FIJOS PARA TORNOS

PUNTO GIRATORIO



	D1 mm	L1 mm	CM INT.	€
CPCM1	12	80	1	15,52
CPCM2	18	100	2	20,63
CPCM3	24	125	3	32,06
CPCM4	31	160	4	50,08
CPCM5	44	200	5	70,76
CPCM6	63	270	6	272,83

MD	€
CPCM2-MD	59,31
CPCM3-MD	80,94
CPCM4-MD	98,72
CPCM5-MD	167,82

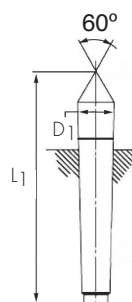

	D1 mm	D2 mm	L1 mm	CM	€
PGCM1	34	18	120	1	148,56
PGCM2	50	21	148	2	165,69
PGCM3	60	24	185	3	222,75
PGCM4	63	30	220	4	264,00
PGCM5	75	44	260	5	381,56

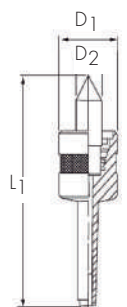

PORTAMACHOS Y CABECILLAS

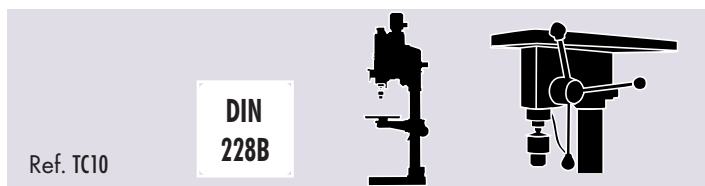

- Con compensación Longitudinal en compresión y tracción.
- Mango Cono Morse

						TC10
	D1 mm	D3 mm	L1 mm	L2 mm	CM	€
TC10-19-CM2	36	19	122	47	2	316,35
TC10-19-CM3	36	19	141	47	3	404,19
TC10-31-CM3	53	31	165	71	3	520,11
TC10-31-CM4	53	31	189	72	4	579,55
TC10-48-CM4	78	48	222	105	4	876,75
TC10-48-CM5	78	48	255	106	5	936,19

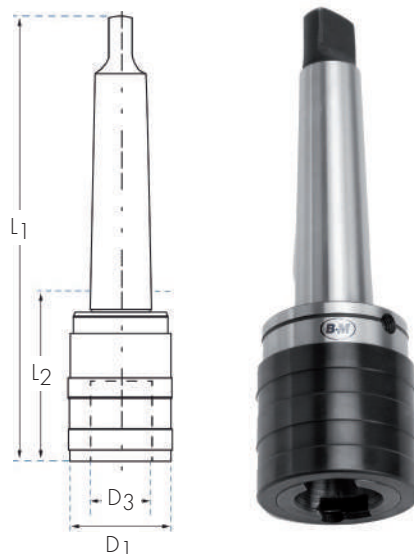

PORTAMACHOS SIN EMBRAGUE

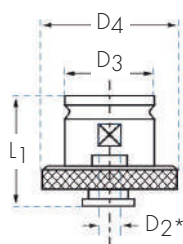

					TC15
	D2 mm	D3 mm	L1 mm	D4 mm	€
TC15-19-035	3,5	19	28	30	42,36
TC15-19-040	4,0	19	28	30	42,36
TC15-19-045	4,5	19	28	30	42,36
TC15-19-060	6,0	19	28	30	42,36
TC15-19-070	7,0	19	28	30	42,36
TC15-19-080	8,0	19	28	30	42,36
TC15-19-090	9,0	19	28	30	42,36
TC15-19-100	10,0	19	28	30	42,36
TC15-31-070	7,0	31	46	48	59,47
TC15-31-080	8,0	31	46	48	59,47
TC15-31-090	9,0	31	46	48	59,47
TC15-31-100	10,0	31	46	48	59,47
TC15-31-110	11,0	31	46	48	59,47
TC15-31-120	12,0	31	46	48	59,47
TC15-31-140	14,0	31	46	48	59,47
TC15-31-160	16,0	31	46	48	59,47
TC15-48-110	11,0	48	69	70	157,57
TC15-48-120	12,0	48	69	70	157,57
TC15-48-140	14,0	48	69	70	157,57
TC15-48-160	16,0	48	69	70	157,57
TC15-48-180	18,0	48	69	70	157,57
TC15-48-200	20,0	48	69	70	157,57
TC15-48-220	22,0	48	69	70	157,57
TC15-48-250	25,0	48	69	70	157,57
TC15-48-280	28,0	48	69	70	157,57

PORTAMACHOS CON EMBRAGUE

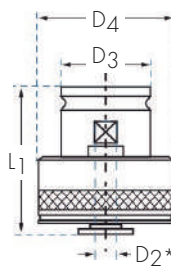

					TC16
	D2 mm	D3 mm	L1 mm	D4 mm	€
TC16-19-035	3,5	19	46	32	101,67
TC16-19-040	4,0	19	46	32	101,67
TC16-19-045	4,5	19	46	32	101,67
TC16-19-060	6,0	19	46	32	101,67
TC16-19-070	7,0	19	46	32	101,67
TC16-19-080	8,0	19	46	32	101,67
TC16-19-090	9,0	19	46	32	101,67
TC16-19-100	10,0	19	46	32	101,67
TC16-31-070	7,0	31	69	50	128,77
TC16-31-080	8,0	31	69	50	128,77
TC16-31-090	9,0	31	69	50	128,77
TC16-31-100	10,0	31	69	50	128,77
TC16-31-110	11,0	31	69	50	128,77
TC16-31-120	12,0	31	69	50	128,77
TC16-31-140	14,0	31	69	50	128,77
TC16-31-160	16,0	31	69	50	128,77
TC16-48-110	11,0	48	100	70	285,09
TC16-48-120	12,0	48	100	70	285,09
TC16-48-140	14,0	48	100	70	285,09
TC16-48-160	16,0	48	100	70	285,09
TC16-48-180	18,0	48	100	70	285,09
TC16-48-200	20,0	48	100	70	285,09
TC16-48-220	22,0	48	100	70	285,09
TC16-48-250	25,0	48	100	70	285,09
TC16-48-280	28,0	48	100	70	285,09

* D2: Ø Mango del macho

* Para informarse sobre el Ø Mango del macho (D2) consultar página 127.

MACHOS M/MF COMPATIBLES PARA PORTAMACHOS CON /SIN EMBRAGUE

D2 mm.								
3,5	4	4,5	6	7	8	9	10	11
M3x0,50R	M3,5x0,60R	M4x0,50R	M4,5x0,50R	M9x1,00D	M8x1,25R	M9x1,25R	M10x1,50R	M13x0,75D
M3x0,60R	M3,5x0,75R	M4x0,70R	M4,5x0,75R	M9x1,25D	M11x0,75D	M12x0,75D		M13x1,00D
M5x0,50D		M4x0,75R	M5x0,50R	M10x0,50D	M11x1,00D	M12x1,00D		M13x1,25D
M5x0,75D		M4x0,80R	M5x0,75R	M10x0,75D	M11x1,25D	M12x1,25D		M13x1,50D
M5x0,80D		M6x0,50D	M5x0,80R	M10x1,00D	M11x1,50D	M12x1,50D		M13x1,75D
M5x0,90D		M6x0,75D	M5x0,90R	M10x1,25D		M12x1,75D		M14x0,75D
		M6x1,00D	M5x1,00R	M10x1,50D				M14x1,00D
			M5,5x0,90R					M14x1,25D
			M6x0,50R					M14x1,50D
			M6x0,75R					M14x2,00D
			M6x1,00R					
			M6x1,25R					
			M8x0,50D					
			M8x0,75D					
			M8x1,00D					
			M8x1,25D					
			M8x1,50D					

D2 mm.							
12	14	16	18	20	22	25	28
M15x1,00D	M18x1,00D	M20x1,00D	M22x1,00D	M27x1,00D	M30x1,00D	M33x1,00D	M34x1,50D
M15x1,25D	M18x1,25D	M20x1,25D	M22x1,25D	M27x1,50D	M30x1,50D	M33x1,50D	M34x2,00D
M15x1,50D	M18x1,50D	M20x1,50D	M22x1,50D	M27x2,00D	M30x2,00D	M33x2,00D	M35x1,50D
M15x2,00D	M18x2,00D	M20x2,00D	M22x2,00D	M27x3,00D	M30x3,00D	M33x3,50D	M35x2,00D
M16x1,00D	M18x2,50D	M20x2,50D	M22x2,50D	M28x1,00D	M30x3,50D		M36x1,50D
M16x1,25D	M19x1,00D	M21x1,00D	M23x1,00D	M28x1,50D	M32x1,00D		M36x2,00D
M16x1,50D	M19x1,25D	M21x1,25D	M23x1,50D	M28x2,00D	M32x1,50D		M36x3,00D
M16x2,00D	M19x1,50D	M21x1,50D	M24x1,00D		M32x2,00D		M36x4,00D
M17x1,00D	M19x2,00D		M24x1,25D				M38x1,50D
M17x1,25D			M24x1,50D				M38x2,00D
M17x1,50D			M24x2,00D				
			M24x3,00D				
			M25x1,00D				
			M25x1,25D				
			M25x1,50D				
			M25x2,00D				
			M26x1,00D				
			M26x1,50D				
			M26x2,00D				

* D2: Mango del macho
 * La tabla se refiere a mangos según norma DIN:
 * R = Reforzado = DIN371
 * D = Delgado = DIN374 / DIN376

PINZAS DE PRECISIÓN

TIPO
ERDIN
6499-B $\alpha: 8^\circ \beta: 30^\circ$

- Pinzas aptas para herramientas con mangos cilíndricos lisos.

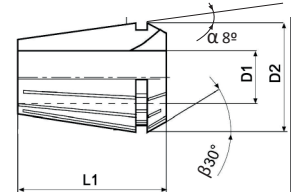

D2: 8,5 L1: 13,5

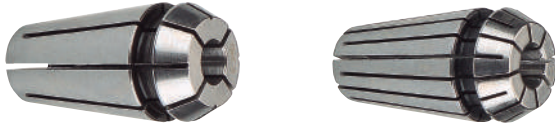

D2: 11,5 L1: 18



ER8

EXC 0,01	INDUSTRIAL		EXC 0,005	ALTA PRECISIÓN	
	Capacidad D1	€		Capacidad D1	€
ER8-1	0,5-1,0	51,98	ER8-1MICRO	0,5-1,0	-
ER8-1,5	1,0-1,5	51,98	ER8-1,5MICRO	1,0-1,5	-
ER8-2	1,5-2,0	44,55	ER8-2MICRO	1,5-2,0	-
ER8-2,5	2,0-2,5	44,55	ER8-2,5MICRO	2,0-2,5	-
ER8-3	2,5-3,0	39,11	ER8-3MICRO	2,5-3,0	-
ER8-3,5	3,0-3,5	39,11	ER8-3,5MICRO	3,0-3,5	-
ER8-4	3,5-4,0	39,11	ER8-4MICRO	3,5-4,0	-
ER8-4,5	4,0-4,5	39,11	ER8-4,5MICRO	4,0-4,5	-
ER8-5	4,5-5,0	39,11	ER8-5MICRO	4,5-5,0	-

ER11

EXC 0,01	INDUSTRIAL		EXC 0,005	ALTA PRECISIÓN	
	Capacidad D1	€		Capacidad D1	€
ER11-1	0,5-1,0	49,50	ER11-1MICRO	0,5-1,0	-
ER11-1,5	1,0-1,5	49,50	ER11-1,5MICRO	1,0-1,5	-
ER11-2	1,5-2,0	42,44	ER11-2MICRO	1,5-2,0	-
ER11-2,5	2,0-2,5	42,44	ER11-2,5MICRO	2,0-2,5	-
ER11-3	2,5-3,0	37,26	ER11-3MICRO	2,5-3,0	-
ER11-3,5	3,0-3,5	37,26	ER11-3,5MICRO	3,0-3,5	53,33
ER11-4	3,5-4,0	37,26	ER11-4MICRO	3,5-4,0	53,33
ER11-4,5	4,0-4,5	37,26	ER11-4,5MICRO	4,0-4,5	53,33
ER11-5	4,5-5,0	37,26	ER11-5MICRO	4,5-5,0	53,33
ER11-5,5	5,0-5,5	37,26	ER11-5,5MICRO	5,0-5,5	53,33
ER11-6	5,5-6,0	37,26	ER11-6MICRO	5,5-6,0	53,33
ER11-6,5	6,0-6,6	37,26	ER11-6,5MICRO	6,0-6,6	53,33
ER11-7	6,5-7,0	37,26	ER11-7MICRO	6,5-7,0	53,33

D2: 17 L1: 27,5



D2: 26 L1: 34

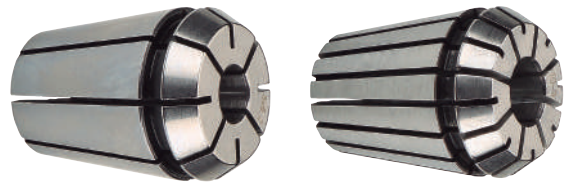

ER16

EXC 0,01	INDUSTRIAL		EXC 0,005	ALTA PRECISIÓN	
	Capacidad D1	€		Capacidad D1	€
ER16-1	0,5-1,0	44,35	ER16-1MICRO	0,5-1,0	-
ER16-2	1,0-2,0	39,93	ER16-2MICRO	1,0-2,0	-
ER16-3	2,0-3,0	35,93	ER16-3MICRO	2,0-3,0	-
ER16-4	3,0-4,0	35,93	ER16-4MICRO	3,0-4,0	47,49
ER16-5	4,0-5,0	35,93	ER16-5MICRO	4,0-5,0	47,49
ER16-6	5,0-6,0	35,93	ER16-6MICRO	5,0-6,0	47,49
ER16-7	6,0-7,0	35,93	ER16-7MICRO	6,0-7,0	47,49
ER16-8	7,0-8,0	35,93	ER16-8MICRO	7,0-8,0	47,49
ER16-9	8,0-9,0	35,93	ER16-9MICRO	8,0-9,0	47,49
ER16-10	9,0-10,0	35,93	ER16-10MICRO	9,0-10,0	47,49

ER25

EXC 0,01	INDUSTRIAL		EXC 0,005	ALTA PRECISIÓN	
	Capacidad D1	€		Capacidad D1	€
ER25-2	1,0-2,0	41,14	ER25-2MICRO	1,0-2,0	-
ER25-3	2,0-3,0	41,14	ER25-3MICRO	2,0-3,0	-
ER25-4	3,0-4,0	41,14	ER25-4MICRO	3,0-4,0	51,15
ER25-5	4,0-5,0	41,14	ER25-5MICRO	4,0-5,0	51,15
ER25-6	5,0-6,0	41,14	ER25-6MICRO	5,0-6,0	51,15
ER25-7	6,0-7,0	41,14	ER25-7MICRO	6,0-7,0	51,15
ER25-8	7,0-8,0	41,14	ER25-8MICRO	7,0-8,0	51,15
ER25-9	8,0-9,0	41,14	ER25-9MICRO	8,0-9,0	51,15
ER25-10	9,0-10,0	41,14	ER25-10MICRO	9,0-10,0	51,15
ER25-11	10,0-11,0	41,14	ER25-11MICRO	10,0-11,0	51,15
ER25-12	11,0-12,0	41,14	ER25-12MICRO	11,0-12,0	51,15
ER25-13	12,0-13,0	41,14	ER25-13MICRO	12,0-13,0	51,15
ER25-14	13,0-14,0	41,14	ER25-14MICRO	13,0-14,0	51,15
ER25-15	14,0-15,0	41,14	ER25-15MICRO	14,0-15,0	51,15
ER25-16	15,0-16,0	41,14	ER25-16MICRO	15,0-16,0	51,15

PINZAS DE PRECISIÓN

**TIPO
ER**

**DIN
6499-B**

$\alpha: 8^\circ \beta: 30^\circ$

- Pinzas aptas para herramientas con mangos cilíndricos lisos.

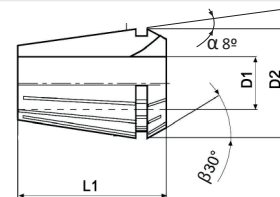

D2: 33 L1: 40

D2: 41 L1: 46

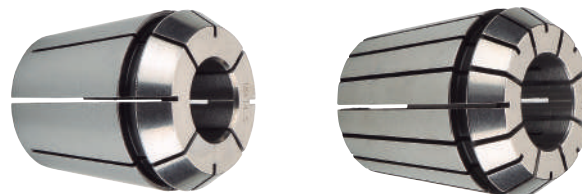
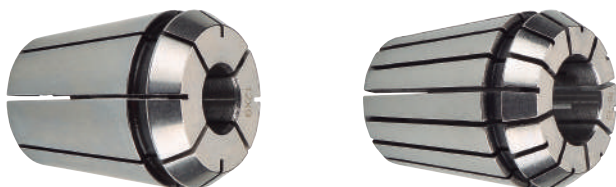

ER32

EXC 0,01	INDUSTRIAL		EXC 0,005	ALTA PRECISIÓN	
	Capacidad D1	€		Capacidad D1	€
ER32-3	2,0-3,0	39,10	ER32-3MICRO	2,0-3,0	-
ER32-4	3,0-4,0	39,10	ER32-4MICRO	3,0-4,0	53,41
ER32-5	4,0-5,0	39,10	ER32-5MICRO	4,0-5,0	53,41
ER32-6	5,0-6,0	39,10	ER32-6MICRO	5,0-6,0	53,41
ER32-7	6,0-7,0	39,10	ER32-7MICRO	6,0-7,0	53,41
ER32-8	7,0-8,0	39,10	ER32-8MICRO	7,0-8,0	53,41
ER32-9	8,0-9,0	39,10	ER32-9MICRO	8,0-9,0	53,41
ER32-10	9,0-10,0	39,10	ER32-10MICRO	9,0-10,0	53,41
ER32-11	10,0-11,0	39,10	ER32-11MICRO	10,0-11,0	53,41
ER32-12	11,0-12,0	39,10	ER32-12MICRO	11,0-12,0	53,41
ER32-13	12,0-13,0	39,10	ER32-13MICRO	12,0-13,0	53,41
ER32-14	13,0-14,0	39,10	ER32-14MICRO	13,0-14,0	53,41
ER32-15	14,0-15,0	39,10	ER32-15MICRO	14,0-15,0	53,41
ER32-16	15,0-16,0	39,10	ER32-16MICRO	15,0-16,0	53,41
ER32-17	16,0-17,0	39,10	ER32-17MICRO	16,0-17,0	53,41
ER32-18	17,0-18,0	39,10	ER32-18MICRO	17,0-18,0	53,41
ER32-19	18,0-19,0	39,10	ER32-19MICRO	18,0-19,0	53,41
ER32-20	19,0-20,0	39,10	ER32-20MICRO	19,0-20,0	53,41

ER40

EXC 0,01	INDUSTRIAL		EXC 0,005	ALTA PRECISIÓN	
	Capacidad D1	€		Capacidad D1	€
ER40-3	2,0-3,0	49,69	ER40-3MICRO	2,0-3,0	-
ER40-4	3,0-4,0	49,69	ER40-4MICRO	3,0-4,0	63,55
ER40-5	4,0-5,0	49,69	ER40-5MICRO	4,0-5,0	63,55
ER40-6	5,0-6,0	49,69	ER40-6MICRO	5,0-6,0	63,55
ER40-7	6,0-7,0	49,69	ER40-7MICRO	6,0-7,0	63,55
ER40-8	7,0-8,0	49,69	ER40-8MICRO	7,0-8,0	63,55
ER40-9	8,0-9,0	49,69	ER40-9MICRO	8,0-9,0	63,55
ER40-10	9,0-10,0	49,69	ER40-10MICRO	9,0-10,0	63,55
ER40-11	10,0-11,0	49,69	ER40-11MICRO	10,0-11,0	63,55
ER40-12	11,0-12,0	49,69	ER40-12MICRO	11,0-12,0	63,55
ER40-13	12,0-13,0	49,69	ER40-13MICRO	12,0-13,0	63,55
ER40-14	13,0-14,0	49,69	ER40-14MICRO	13,0-14,0	63,55
ER40-15	14,0-15,0	49,69	ER40-15MICRO	14,0-15,0	63,55
ER40-16	15,0-16,0	49,69	ER40-16MICRO	15,0-16,0	63,55
ER40-17	16,0-17,0	49,69	ER40-17MICRO	16,0-17,0	63,55
ER40-18	17,0-18,0	49,69	ER40-18MICRO	17,0-18,0	63,55
ER40-19	18,0-19,0	49,69	ER40-19MICRO	18,0-19,0	63,55
ER40-20	19,0-20,0	49,69	ER40-20MICRO	19,0-20,0	63,55
ER40-21	20,0-21,0	49,69	ER40-21MICRO	20,0-21,0	63,55
ER40-22	21,0-22,0	49,69	ER40-22MICRO	21,0-22,0	63,55
ER40-23	22,0-23,0	49,69	ER40-23MICRO	22,0-23,0	63,55
ER40-24	23,0-24,0	49,69	ER40-24MICRO	23,0-24,0	63,55
ER40-25	24,0-25,0	49,69	ER40-25MICRO	24,0-25,0	63,55
ER40-26	25,0-26,0	49,69	ER40-26MICRO	25,0-26,0	63,55

AFILADORA PROFESIONAL PATENTADA BLUE-MASTER



*Incluye maletín y muela de repuesto



Ref. AFB10



		AFB10				
CAPACIDAD AFILADO:	Ø	3-13				
ÁNGULOS DE PUNTA:		118°				
TIPOS DE AFILADOS:						
REAFILA BROCAS:	HSS	HSSCo	MD	TiN	PMD	
283,04 €						



"Olvide los problemas eléctricos de otras afiladoras"
Incluye dispositivo anti-cortocircuitos

AFILE BROCAS EN 4 SENCILLOS PASOS:



1
Posicione y ajuste la broca en el portabrocas



2
Afile la broca



3
Compruebe el afilado convencional



4
Afilado secundario en cruz (Split Point)

PORTABROCAS DE REPUESTO



PAFB10
33,25 €

MUELA DE DIAMANTE GRANO ESTANDAR



MAFB10
34,81 €

SOPORTE PARA AFB10



SOPAFB10
31,16 €

AFILADORAS PARA BROCAS DRILL DOCTOR

750X
Alta precisión



AFB1

CAPACIDAD AFILADO:	Ø 2,5-19				
ÁNGULOS DE PUNTA:	118°	135°			
TIPOS DE AFILADOS:					
REAFILA BROCAS:	HSS	HSSCo	MD	TiN	PMD

*Incluye maletín

520,19 €

Portabrocas y accesorios

Rosa

500X
Afilado profesional



AFB2

CAPACIDAD AFILADO:	Ø 2,5-13				
ÁNGULOS DE PUNTA:	118°	135°			
TIPOS DE AFILADOS:					
REAFILA BROCAS:	HSS	HSSCo	MD	TiN	PMD

436,95 €

XP
Práctico y económico



AFB3

CAPACIDAD AFILADO:	Ø 2,5-13				
ÁNGULOS DE PUNTA:	118°				
TIPOS DE AFILADOS:					
REAFILA BROCAS:	HSS	HSSCo	MD	TiN	PMD

210,57 €

ACCESORIOS PARA AFILADORAS

PORTABROCAS PARA AFILADORAS



Para 750X

AFB1PB

78,72 €

Para Brocas a
izquierdas

AFB2PBI

78,74 €

MUELA DE GRANO BASTO PARA AFILADORAS 750X, 500X



AFBT

73,14 €



AFBR

73,14 €

TORNILLOS PARA AFILADORAS 750X Y 500X



AFBTLL

8,63 €

SOPORTE PARA AFB10



SOPAFB10

31,16 €