



BLUE-MASTER[®]
by *CE/ESA*



BUCHAS

BUCHAS INDUSTRIAIS PARA FURADEIRA DE COLUNA OU CNC

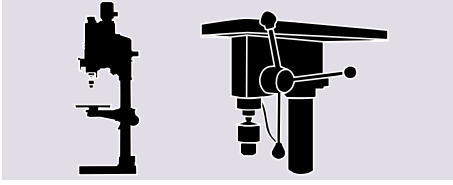

PREC.
<0,05

Ref. DC1

ALTA PRECISÃO

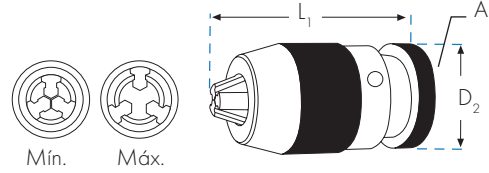

DC1						
	PRECISÃO mm	Mín.-Máx. mm	A	D2 mm	L1 mm	€
DC1-20-B22	<0,05	5-20	B22	58	130	206,12

PREC.
<0,20

Ref. DC3

INDUSTRIAL LEVE

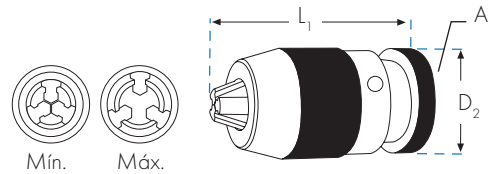

DC3						
	PRECISÃO mm	Mín.-Máx. mm	A	D2 mm	L1 mm	€
DC3-13-B16	<0,20	1-13	B16	43	94	81,90
DC3-13-3/8	<0,20	1-13	3/8-24 UNF	43	94	81,90
DC3-13-1/2	<0,20	1-13	1/2-20 UNF	43	94	81,90
DC3-16-B16	<0,20	1-16	B16	48	119	127,11
DC3-16-B18	<0,20	1-16	B18	48	119	127,11

BUCHAS INDUSTRIAIS COM CABO CÔNICO PARA FURADEIRA DE COLUNA OU CNC

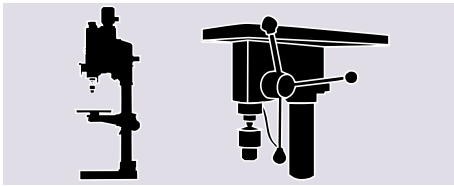

**PREC.
<0,05**

Ref. DC10

ALTA PRECISÃO

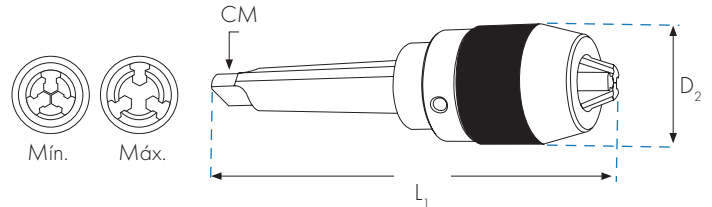

DC10						
	PRECISÃO mm	Mín.-Máx. mm	CM	D2 mm	L1 mm	€
DC10-13-CM3	<0,05	1-13	CM3	51	192	264,23
DC10-13-CM4	<0,05	1-13	CM4	51	218	266,79
DC10-16-CM3	<0,05	1-16	CM3	56	207	270,16

**PREC.
<0,12**

Ref. DC11

INDUSTRIAL

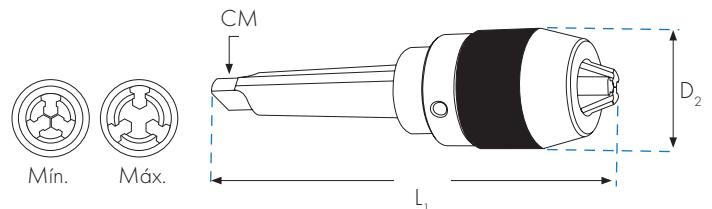

DC11						
	PRECISÃO mm	Mín.-Máx. mm	CM	D2 mm	L1 mm	€
DC11-13-CM2	<0,12	1-13	CM2	51	174	159,55
DC11-13-CM3	<0,12	1-13	CM3	51	192	159,55
DC11-13-CM4	<0,12	1-13	CM4	51	218	159,55
DC11-16-CM3	<0,12	1-16	CM3	56	207	187,07

CHAVE DE PIVÔ PARA BUCHAS DC11



NEW DC20				
	Mín.-Máx. mm	D2 mm	L1 mm	€
DC20-1	1-13	4-5	180	11,59
DC20-2	1-16	4-5	190	13,65

BUCHAS AUTOMATICAS PROFISSIONAIS

<950W

Ref. DC4



- Bloqueio automático.
- Corpo de plástico.
- Furação tanto em modo rotação como em percussão.

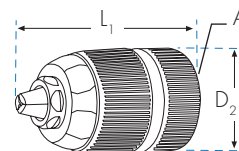
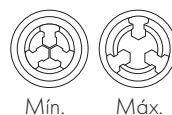

						DC4
	W	Mín.-Máx. mm	A	D2 mm	L1 mm	€
DC4-13-1/2	<950	1,5-13	1/2-20 UNF	43	75	37,98
DC4-13-1/2-SDS	<950	1,5-13	1/2-20 UNF	43	75	43,81

Ref. DC4-13-1/2-SDS

<1050W

Ref. DC5



- Bloqueio automático.
- Corpo de metal.
- Alta potência.
- Garras especiais para alto rendimento.
- Furação tanto em modo rotação como em percussão.

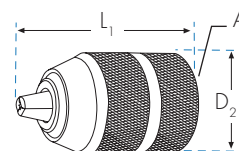
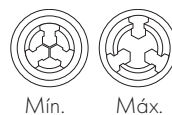

						DC5
	W	Mín.-Máx. mm	A	D2 mm	L1 mm	€
DC5-13-1/2	<1050	1,5-13	1/2-20 UNF	43	75	50,09
DC5-13-SDS	<1050	1,5-13	1/2-20 UNF	43	75	57,86

Ref. DC5-13-SDS

<950W

Ref. DC13



- Bloqueia-se girando o berbequim e pressionando a bucha levemente com a mão.
- Desenhado para berbequins leves de bateria.
- Corpo de plástico.



						DC13
	W	Mín.-Máx. mm	A	D2 mm	L1 mm	€
DC13-10-1/2	<950W	0,8-10	1/2-20 UNF	40	65	12,75

Ref. DC13-10-1/2

BUCHAS DE CHAVE PROFSSIONAIS



Ref. DC6

- Admite percussão, mas recomenda-se o uso em modo rotação.
- Inclui a chave.

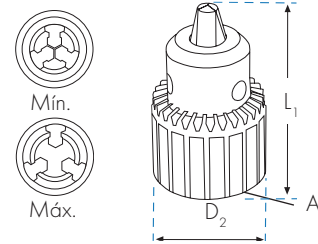

					DC6
	Mín.-Máx. mm	A	D2 mm	L1 mm	€
DC6-06-B10	0,5-6,5	B10	31	50	38,09
DC6-06-3/8	0,5-6,5	3/8-24 UNF	31	50	38,09
DC6-10-1/2	1-10	1/2-20 UNF	37	60	29,83
DC6-13-B12	1-13	B12	46	78	39,01
DC6-13-3/8	1-13	3/8-24 UNF	46	78	39,01
DC6-16-B16	1-16	B16	57	95	43,60
DC6-19-B22	5-20	B22	68	115	59,66

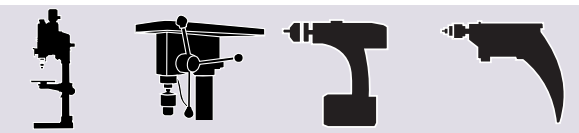

Ref. DC7

LEVE

- Furação tanto em modo rotação como em percussão.
- Inclui a chave.

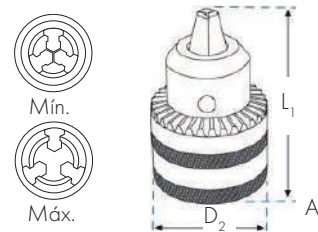

Ref. DC7-13-SDS

					DC7
	Mín.-Máx. mm	A	D2 mm	L1 mm	€
DC7-06-B10	0,6-6,5	B10	30	50	16,36
DC7-06-3/8	0,6-6,5	3/8-24 UNF	30	50	16,36
DC7-10-1/2	1,5-10	1/2-20 UNF	33	59	15,00
DC7-13-B12	1,5-13	B12	42	70	19,00
DC7-13-B16	1,5-13	B16	42	70	19,00
DC7-13-3/8	1,5-13	3/8-24 UNF	42	70	19,00
DC7-13-1/2	1,5-13	1/2-20 UNF	42	70	19,00
DC7-13-SDS	1,5-13	1/2-20 UNF	42	70	19,99
DC7-16-1/2	3-16	1/2-20 UNF	51	87	24,00

BUCHA COM EXTENSÃO FLEXÍVEL

Ref. DC15-001

- Extensão flexível de 1050 mm.
- Bucha automática de 1 a 6 mm de capacidade.
- Velocidade máxima de trabalho 6000 rpm.



DC15-001				
	Mín.-Máx. mm	D2 mm	L1 mm	€
DC15-001	1-6	30	1050	35,15

BUCHA EM ÂNGULO

Ref. DC15-002

- Indicada para trabalhar em lugares de difícil acesso.
- Usar exclusivamente em modo rotação.
- Bucha automática de 1 a 10 mm de capacidade.
- Desenho leve. Inclui alça para canhotos e destros.



DC15-002				
	Mín.-Máx. mm	D2 mm	α	€
DC15-002	1-10	41	90°	20,58

MINI-BUCHA CABO SEXTAVADO



P29

- Cabo 1/4 Sext.
- De 0,6 até 6,0 mm

18,48

SUPORE DE COLUNA PROFISSIONAL PARA BERBEQUIM

- Alça retrátil (recupera a posição de forma rápida, simples e sem esforço nenhum).
- Regra de verificação da perfuração, 60 mm da profundidade.
- Suporte de coluna profissional para perfuração com Ø43/38mm. Coluna robusta de Ø 40 mm.
- Base de ferro fundido com guias para garras de fixação e furos para a sua ancoragem na mesa de trabalho.
- Furação precisa de superfícies, peças de trabalho redondas ou barras.

Ref. STE99

**43/38
mm**

**60
mm**

**510
mm**

				STE99
	Ø Amarração mm	Profundidade furação mm	Altura mm	€
STE99	43/38	60	510	66,74

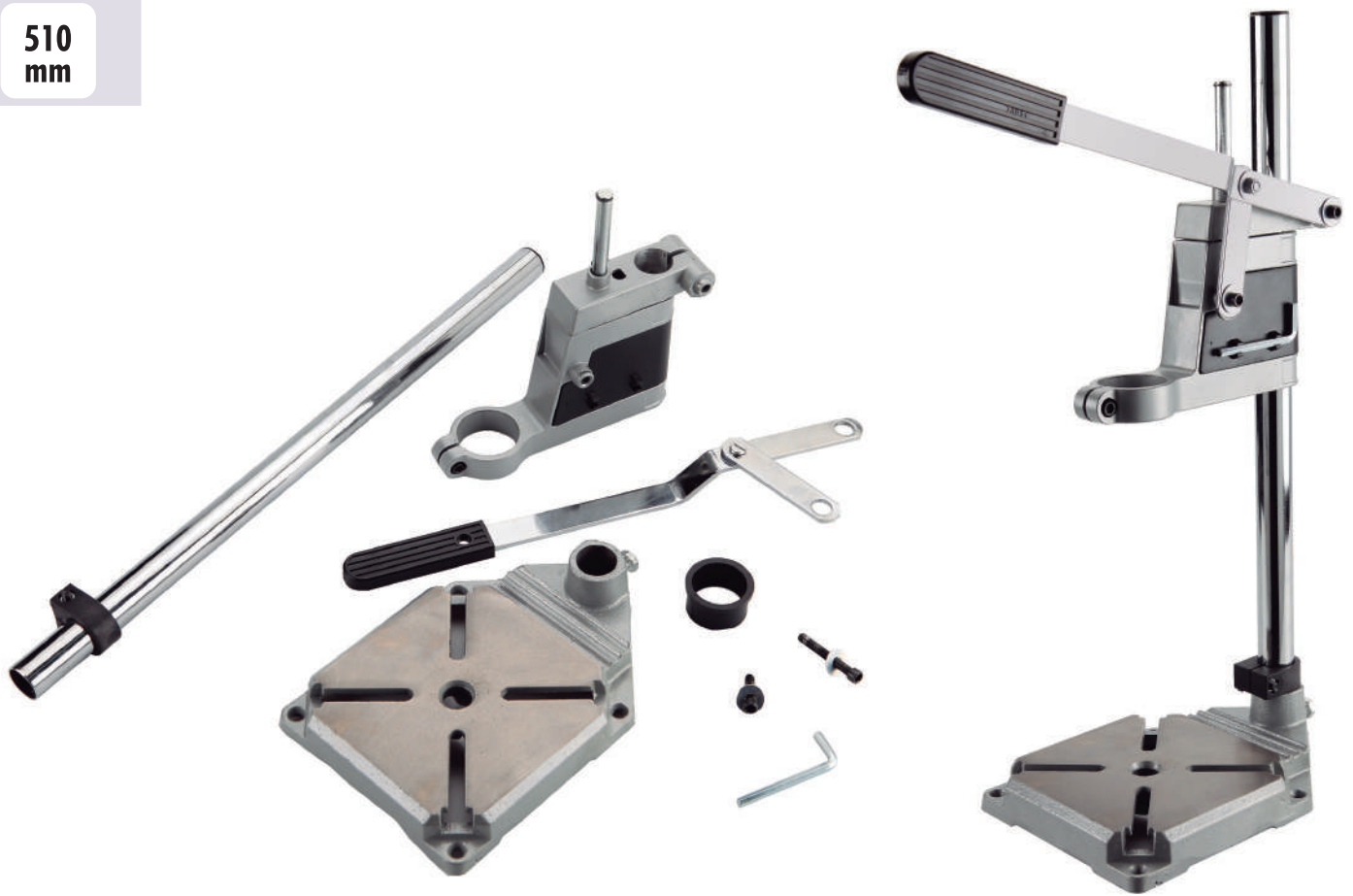

ACESSÓRIOS PARA BROCAS E BUCHAS

CHAVES PARA BUCHAS



	DC		
	Mín.-Máx. mm	Ø mm	€
DC-10	1 - 10	6	4,43
DC-13	1 - 13	6	5,41
DC-16	1 - 16	8	6,73
DC-20	5 - 20	9	11,94



ADAPTADORES SDS PLUS



	DC	
	Rosca (A)	€
DC -3/8	3/8 - 24 UNF	15,01
DC -1/2	1/2 - 20 UNF	15,01



ADAPTADOR 1/4 SEXT.



	DC-01		
	Cabo	Rosca	€
DC-01	1/4" Hex.	3/8 - 24 UNF	8,68

CONES PARA REDUÇÃO

DIN
2185

CONE MORSE		L1 mm	CR	
EXT.	INT.		€	€
1	0	80	24,13	
2	1	92	23,80	
3	1	99	32,51	
3	2	112	33,12	
4	1	124	50,05	
4	2	124	47,03	
4	3	140	47,03	

CONE MORSE		L1 mm	CR	
EXT.	INT.		€	€
5	1	156	86,15	
5	2	156	78,63	
5	3	156	78,63	
5	4	171	80,28	
6	3	218	150,61	
6	4	218	170,89	
6	5	218	170,89	

CONES PARA AUMENTO

DIN
2187

CONE MORSE		L1 mm	D1 mm	CA	
EXT.	INT.			€	€
1	2	160	30	49,99	
2	3	196	36	67,96	
3	4	240	48	114,61	
4	5	300	63	192,37	
5	6	415	80	540,64	

CONES PARA REDUÇÃO E EXTENSÃO

DIN
2187

CONE MORSE		L1 mm	CA	
EXT.	INT.		€	€
2	1	160	33,63	
3	1	175	46,78	
3	2	194	50,49	
4	1	200	70,82	
4	2	215	69,23	
4	3	240	72,43	
5	1	232	172,05	

CONE MORSE		L1 mm	CA	
EXT.	INT.		€	€
5	2	247	156,42	
5	3	268	137,84	
5	4	300	155,80	
6	3	330	355,44	
6	4	355	355,44	
6	5	390	358,08	

CONES PARA EXTENSÃO

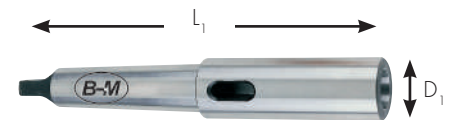

CONE MORSE		L1 mm	D1 mm	CA	
EXT.	INT.			€	€
1	1	145	20	32,71	
2	2	175	30	47,59	
3	3	215	36	72,08	
4	4	265	48	131,29	
5	5	335	63	247,32	
6	6	470	85	567,66	

ACESSÓRIOS PARA BROCAS E BUCHAS

ESPIGAS DE SUJEIÇÃO COM CABO CÔNICO PARA BUCHAS

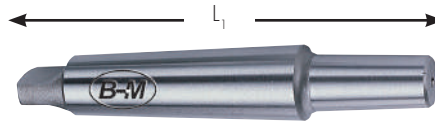

EXTRATOR PARA ESPIGAS DE SUJEIÇÃO DE BUCHAS CON CONE PADRÃO B16 E B18



CMEXT
48,16 €

CM	BUCHA	L1 mm	€	CM	BUCHA	L1 mm	€
1	B10	86	14,33	3	B22	147	26,82
1	B12	89	10,76	3	B24	157	39,56
1	B16	99	10,76	4	B16	158	23,96
1	B18	107	12,34	4	B18	166	24,60
2	B10	105	17,13	4	B22	176	44,24
2	B12	106	13,08	4	B24	186	44,74
2	B16	112	13,08	5	B16	193	86,77
2	B18	119	13,08	5	B18	200	86,77
2	B22	130	25,78	5	B22	208	90,51
3	B12	127	19,69	5	B24	221	98,32
3	B16	134	15,93	6	B22	240	184,89
3	B18	140	15,93				

CUNHA PARA EXPULSÃO



DIN 317

Nº	VÁLIDOS CM	L1 mm	€
0	0	90	14,32
1	1 / 2	140	16,92
3	3	190	22,34
4	4	225	30,40
5	5 / 6	265	49,36

ESPIGAS DE SUJEIÇÃO COM CABO CÔNICO PARA BUCHAS DE ROSCA



DIN 228

	CM	A	€	CMR	CM	A	€
CMR1-3/8	1	3/8-24h	21,14	CMR2-5/8	2	5/8-16h	21,14
CMR1-1/2	1	1/2-20h	21,14	CMR3-3/8	3	3/8-24h	28,60
CMR2-3/8	2	3/8-24h	21,14	CMR3-1/2	3	1/2-20h	28,60
CMR2-1/2	2	1/2-20h	21,14	CMR3-5/8	3	5/8-16h	28,60

ACESSÓRIOS PARA BROCAS

CONTRAPONTO FIXOS PARA TORNO

PONTO GIRATORIO

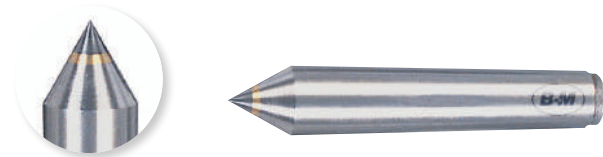

	D1 mm	L1 mm	CM INT.	€	MD	€
CPCM1	12	80	1	15,52		
CPCM2	18	100	2	20,63	CPCM2-MD	59,31
CPCM3	24	125	3	32,06	CPCM3-MD	80,94
CPCM4	31	160	4	50,08	CPCM4-MD	98,72
CPCM5	44	200	5	70,76	CPCM5-MD	167,82
CPCM6	63	270	6	272,83		

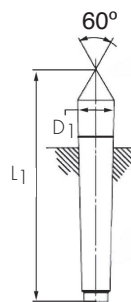

	D1 mm	D2 mm	L1 mm	CM	€
PGCM1	34	18	120	1	148,56
PGCM2	50	21	148	2	165,69
PGCM3	60	24	185	3	222,75
PGCM4	63	30	220	4	264,00
PGCM5	75	44	260	5	381,56

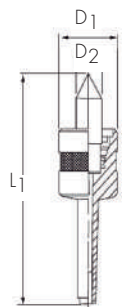

PORTAMACHOS E CABEÇAS

DIN
228B

Ref. TC10

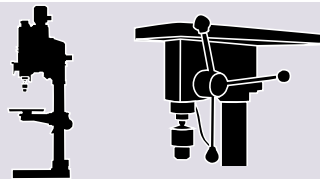

- Com compensação longitudinal em compressão e tracção.
- Cabo Cone Morse.

	D1 mm	D3 mm	L1 mm	L2 mm	CM	TC10
						€
TC10-19-CM2	36	19	122	47	2	316,35
TC10-19-CM3	36	19	141	47	3	404,19
TC10-31-CM3	53	31	165	71	3	520,11
TC10-31-CM4	53	31	189	72	4	579,55
TC10-48-CM4	78	48	222	105	4	876,75
TC10-48-CM5	78	48	255	106	5	936,19

PORTAMACHOS SEM EMBREAGEM

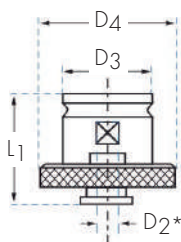

PORTAMACHOS COM EMBREAGEM

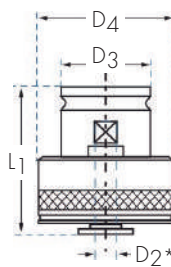

	D2 mm	D3 mm	L1 mm	D4 mm	TC15
					€
TC15-19-035	3,5	19	28	30	42,36
TC15-19-040	4,0	19	28	30	42,36
TC15-19-045	4,5	19	28	30	42,36
TC15-19-060	6,0	19	28	30	42,36
TC15-19-070	7,0	19	28	30	42,36
TC15-19-080	8,0	19	28	30	42,36
TC15-19-090	9,0	19	28	30	42,36
TC15-19-100	10,0	19	28	30	42,36
TC15-31-070	7,0	31	46	48	59,47
TC15-31-080	8,0	31	46	48	59,47
TC15-31-090	9,0	31	46	48	59,47
TC15-31-100	10,0	31	46	48	59,47
TC15-31-110	11,0	31	46	48	59,47
TC15-31-120	12,0	31	46	48	59,47
TC15-31-140	14,0	31	46	48	59,47
TC15-31-160	16,0	31	46	48	59,47
TC15-48-110	11,0	48	69	70	157,57
TC15-48-120	12,0	48	69	70	157,57
TC15-48-140	14,0	48	69	70	157,57
TC15-48-160	16,0	48	69	70	157,57
TC15-48-180	18,0	48	69	70	157,57
TC15-48-200	20,0	48	69	70	157,57
TC15-48-220	22,0	48	69	70	157,57
TC15-48-250	25,0	48	69	70	157,57
TC15-48-280	28,0	48	69	70	157,57

	D2 mm	D3 mm	L1 mm	D4 mm	TC16
					€
TC16-19-035	3,5	19	46	32	101,67
TC16-19-040	4,0	19	46	32	101,67
TC16-19-045	4,5	19	46	32	101,67
TC16-19-060	6,0	19	46	32	101,67
TC16-19-070	7,0	19	46	32	101,67
TC16-19-080	8,0	19	46	32	101,67
TC16-19-090	9,0	19	46	32	101,67
TC16-19-100	10,0	19	46	32	101,67
TC16-31-070	7,0	31	69	50	128,77
TC16-31-080	8,0	31	69	50	128,77
TC16-31-090	9,0	31	69	50	128,77
TC16-31-100	10,0	31	69	50	128,77
TC16-31-110	11,0	31	69	50	128,77
TC16-31-120	12,0	31	69	50	128,77
TC16-31-140	14,0	31	69	50	128,77
TC16-31-160	16,0	31	69	50	128,77
TC16-48-110	11,0	48	100	70	285,09
TC16-48-120	12,0	48	100	70	285,09
TC16-48-140	14,0	48	100	70	285,09
TC16-48-160	16,0	48	100	70	285,09
TC16-48-180	18,0	48	100	70	285,09
TC16-48-200	20,0	48	100	70	285,09
TC16-48-220	22,0	48	100	70	285,09
TC16-48-250	25,0	48	100	70	285,09
TC16-48-280	28,0	48	100	70	285,09

* D2: Ø Cabo do macho.

* Para obter informações sobre o (D2) do cabo do macho consultar na página 127.

MACHOS M/MF COMPATÍVEIS PARA PORTAMACHOS COM/SEM EMBREAGEM

D2 mm.								
3,5	4	4,5	6	7	8	9	10	11
M3x0,50R	M3,5x0,60R	M4x0,50R	M4,5x0,50R	M9x1,00D	M8x1,25R	M9x1,25R	M10x1,50R	M13x0,75D
M3x0,60R	M3,5x0,75R	M4x0,70R	M4,5x0,75R	M9x1,25D	M11x0,75D	M12x0,75D		M13x1,00D
M5x0,50D		M4x0,75R	M5x0,50R	M10x0,50D	M11x1,00D	M12x1,00D		M13x1,25D
M5x0,75D		M4x0,80R	M5x0,75R	M10x0,75D	M11x1,25D	M12x1,25D		M13x1,50D
M5x0,80D		M6x0,50D	M5x0,80R	M10x1,00D	M11x1,50D	M12x1,50D		M13x1,75D
M5x0,90D		M6x0,75D	M5x0,90R	M10x1,25D		M12x1,75D		M14x0,75D
		M6x1,00D	M5x1,00R	M10x1,50D				M14x1,00D
			M5,5x0,90R					M14x1,25D
			M6x0,50R					M14x1,50D
			M6x0,75R					M14x2,00D
			M6x1,00R					
			M6x1,25R					
			M8x0,50D					
			M8x0,75D					
			M8x1,00D					
			M8x1,25D					
			M8x1,50D					

D2 mm.							
12	14	16	18	20	22	25	28
M15x1,00D	M18x1,00D	M20x1,00D	M22x1,00D	M27x1,00D	M30x1,00D	M33x1,00D	M34x1,50D
M15x1,25D	M18x1,25D	M20x1,25D	M22x1,25D	M27x1,50D	M30x1,50D	M33x1,50D	M34x2,00D
M15x1,50D	M18x1,50D	M20x1,50D	M22x1,50D	M27x2,00D	M30x2,00D	M33x2,00D	M35x1,50D
M15x2,00D	M18x2,00D	M20x2,00D	M22x2,00D	M27x3,00D	M30x3,00D	M33x3,50D	M35x2,00D
M16x1,00D	M18x2,50D	M20x2,50D	M22x2,50D	M28x1,00D	M30x3,50D		M36x1,50D
M16x1,25D	M19x1,00D	M21x1,00D	M23x1,00D	M28x1,50D	M32x1,00D		M36x2,00D
M16x1,50D	M19x1,25D	M21x1,25D	M23x1,50D	M28x2,00D	M32x1,50D		M36x3,00D
M16x2,00D	M19x1,50D	M21x1,50D	M24x1,00D		M32x2,00D		M36x4,00D
M17x1,00D	M19x2,00D		M24x1,25D				M38x1,50D
M17x1,25D			M24x1,50D				M38x2,00D
M17x1,50D			M24x2,00D				
			M24x3,00D				
			M25x1,00D				
			M25x1,25D				
			M25x1,50D				
			M25x2,00D				
			M26x1,00D				
			M26x1,50D				
			M26x2,00D				

* D2: Cabo do macho.

* A tabela refere-se aos cabos conforme a norma DIN.

* R = Reforçado = DIN371.

* D = Delgado = DIN374 / DIN376.

PINÇAS DE PRECISÃO

TIPO
ERDIN
6499-B $\alpha: 8^\circ \beta: 30^\circ$

- Pinças aptas para ferramentas com cabos cilíndricos lisos.

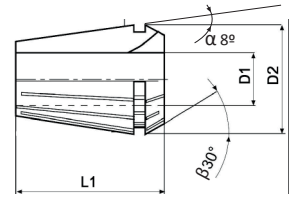

D2: 8,5 L1: 13,5

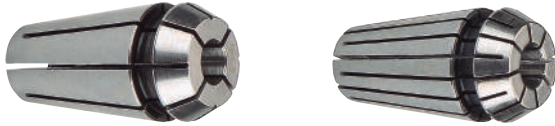

D2: 11,5 L1: 18



ER8

EXC 0,01	INDUSTRIAL		EXC 0,005	ALTA PRECISÃO	
	Capacidade D1	€		Capacidade D1	€
ER8-1	0,5-1,0	51,98	ER8-1MICRO	0,5-1,0	-
ER8-1,5	1,0-1,5	51,98	ER8-1,5MICRO	1,0-1,5	-
ER8-2	1,5-2,0	44,55	ER8-2MICRO	1,5-2,0	-
ER8-2,5	2,0-2,5	44,55	ER8-2,5MICRO	2,0-2,5	-
ER8-3	2,5-3,0	39,11	ER8-3MICRO	2,5-3,0	-
ER8-3,5	3,0-3,5	39,11	ER8-3,5MICRO	3,0-3,5	-
ER8-4	3,5-4,0	39,11	ER8-4MICRO	3,5-4,0	-
ER8-4,5	4,0-4,5	39,11	ER8-4,5MICRO	4,0-4,5	-
ER8-5	4,5-5,0	39,11	ER8-5MICRO	4,5-5,0	-

ER11

EXC 0,01	INDUSTRIAL		EXC 0,005	ALTA PRECISÃO	
	Capacidade D1	€		Capacidade D1	€
ER11-1	0,5-1,0	49,50	ER11-1MICRO	0,5-1,0	-
ER11-1,5	1,0-1,5	49,50	ER11-1,5MICRO	1,0-1,5	-
ER11-2	1,5-2,0	42,44	ER11-2MICRO	1,5-2,0	-
ER11-2,5	2,0-2,5	42,44	ER11-2,5MICRO	2,0-2,5	-
ER11-3	2,5-3,0	37,26	ER11-3MICRO	2,5-3,0	-
ER11-3,5	3,0-3,5	37,26	ER11-3,5MICRO	3,0-3,5	53,33
ER11-4	3,5-4,0	37,26	ER11-4MICRO	3,5-4,0	53,33
ER11-4,5	4,0-4,5	37,26	ER11-4,5MICRO	4,0-4,5	53,33
ER11-5	4,5-5,0	37,26	ER11-5MICRO	4,5-5,0	53,33
ER11-5,5	5,0-5,5	37,26	ER11-5,5MICRO	5,0-5,5	53,33
ER11-6	5,5-6,0	37,26	ER11-6MICRO	5,5-6,0	53,33
ER11-6,5	6,0-6,6	37,26	ER11-6,5MICRO	6,0-6,6	53,33
ER11-7	6,5-7,0	37,26	ER11-7MICRO	6,5-7,0	53,33

D2: 17 L1: 27,5



D2: 26 L1: 34

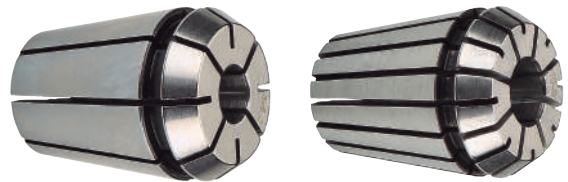

ER16

EXC 0,01	INDUSTRIAL		EXC 0,005	ALTA PRECISÃO	
	Capacidade D1	€		Capacidade D1	€
ER16-1	0,5-1,0	44,35	ER16-1MICRO	0,5-1,0	-
ER16-2	1,0-2,0	39,93	ER16-2MICRO	1,0-2,0	-
ER16-3	2,0-3,0	35,93	ER16-3MICRO	2,0-3,0	-
ER16-4	3,0-4,0	35,93	ER16-4MICRO	3,0-4,0	47,49
ER16-5	4,0-5,0	35,93	ER16-5MICRO	4,0-5,0	47,49
ER16-6	5,0-6,0	35,93	ER16-6MICRO	5,0-6,0	47,49
ER16-7	6,0-7,0	35,93	ER16-7MICRO	6,0-7,0	47,49
ER16-8	7,0-8,0	35,93	ER16-8MICRO	7,0-8,0	47,49
ER16-9	8,0-9,0	35,93	ER16-9MICRO	8,0-9,0	47,49
ER16-10	9,0-10,0	35,93	ER16-10MICRO	9,0-10,0	47,49

ER25

EXC 0,01	INDUSTRIAL		EXC 0,005	ALTA PRECISÃO	
	Capacidade D1	€		Capacidade D1	€
ER25-2	1,0-2,0	41,14	ER25-2MICRO	1,0-2,0	-
ER25-3	2,0-3,0	41,14	ER25-3MICRO	2,0-3,0	-
ER25-4	3,0-4,0	41,14	ER25-4MICRO	3,0-4,0	51,15
ER25-5	4,0-5,0	41,14	ER25-5MICRO	4,0-5,0	51,15
ER25-6	5,0-6,0	41,14	ER25-6MICRO	5,0-6,0	51,15
ER25-7	6,0-7,0	41,14	ER25-7MICRO	6,0-7,0	51,15
ER25-8	7,0-8,0	41,14	ER25-8MICRO	7,0-8,0	51,15
ER25-9	8,0-9,0	41,14	ER25-9MICRO	8,0-9,0	51,15
ER25-10	9,0-10,0	41,14	ER25-10MICRO	9,0-10,0	51,15
ER25-11	10,0-11,0	41,14	ER25-11MICRO	10,0-11,0	51,15
ER25-12	11,0-12,0	41,14	ER25-12MICRO	11,0-12,0	51,15
ER25-13	12,0-13,0	41,14	ER25-13MICRO	12,0-13,0	51,15
ER25-14	13,0-14,0	41,14	ER25-14MICRO	13,0-14,0	51,15
ER25-15	14,0-15,0	41,14	ER25-15MICRO	14,0-15,0	51,15
ER25-16	15,0-16,0	41,14	ER25-16MICRO	15,0-16,0	51,15

PINÇAS DE PRECISÃO

**TIPO
ER**

**DIN
6499-B**

$\alpha: 8^\circ \beta: 30^\circ$

- Pinças aptas para ferramentas com cabos cilíndricos lisos.

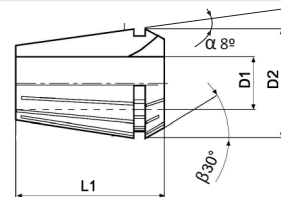

D2: 33 L1: 40

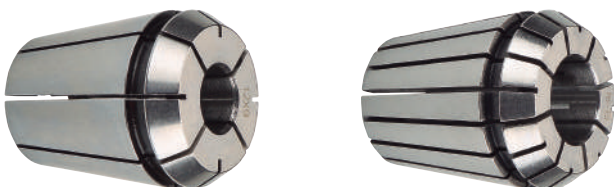

D2: 41 L1: 46

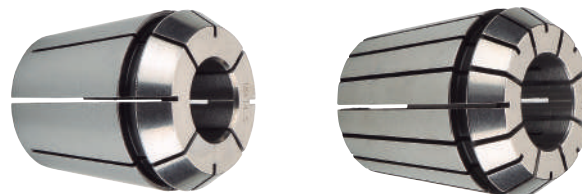

ER32

EXC 0,01	INDUSTRIAL		EXC 0,005	ALTA PRECISÃO	
	Capacidade D1	€		Capacidade D1	€
ER32-3	2,0-3,0	39,10	ER32-3MICRO	2,0-3,0	-
ER32-4	3,0-4,0	39,10	ER32-4MICRO	3,0-4,0	53,41
ER32-5	4,0-5,0	39,10	ER32-5MICRO	4,0-5,0	53,41
ER32-6	5,0-6,0	39,10	ER32-6MICRO	5,0-6,0	53,41
ER32-7	6,0-7,0	39,10	ER32-7MICRO	6,0-7,0	53,41
ER32-8	7,0-8,0	39,10	ER32-8MICRO	7,0-8,0	53,41
ER32-9	8,0-9,0	39,10	ER32-9MICRO	8,0-9,0	53,41
ER32-10	9,0-10,0	39,10	ER32-10MICRO	9,0-10,0	53,41
ER32-11	10,0-11,0	39,10	ER32-11MICRO	10,0-11,0	53,41
ER32-12	11,0-12,0	39,10	ER32-12MICRO	11,0-12,0	53,41
ER32-13	12,0-13,0	39,10	ER32-13MICRO	12,0-13,0	53,41
ER32-14	13,0-14,0	39,10	ER32-14MICRO	13,0-14,0	53,41
ER32-15	14,0-15,0	39,10	ER32-15MICRO	14,0-15,0	53,41
ER32-16	15,0-16,0	39,10	ER32-16MICRO	15,0-16,0	53,41
ER32-17	16,0-17,0	39,10	ER32-17MICRO	16,0-17,0	53,41
ER32-18	17,0-18,0	39,10	ER32-18MICRO	17,0-18,0	53,41
ER32-19	18,0-19,0	39,10	ER32-19MICRO	18,0-19,0	53,41
ER32-20	19,0-20,0	39,10	ER32-20MICRO	19,0-20,0	53,41

ER40

EXC 0,01	INDUSTRIAL		EXC 0,005	ALTA PRECISÃO	
	Capacidade D1	€		Capacidade D1	€
ER40-3	2,0-3,0	49,69	ER40-3MICRO	2,0-3,0	-
ER40-4	3,0-4,0	49,69	ER40-4MICRO	3,0-4,0	63,55
ER40-5	4,0-5,0	49,69	ER40-5MICRO	4,0-5,0	63,55
ER40-6	5,0-6,0	49,69	ER40-6MICRO	5,0-6,0	63,55
ER40-7	6,0-7,0	49,69	ER40-7MICRO	6,0-7,0	63,55
ER40-8	7,0-8,0	49,69	ER40-8MICRO	7,0-8,0	63,55
ER40-9	8,0-9,0	49,69	ER40-9MICRO	8,0-9,0	63,55
ER40-10	9,0-10,0	49,69	ER40-10MICRO	9,0-10,0	63,55
ER40-11	10,0-11,0	49,69	ER40-11MICRO	10,0-11,0	63,55
ER40-12	11,0-12,0	49,69	ER40-12MICRO	11,0-12,0	63,55
ER40-13	12,0-13,0	49,69	ER40-13MICRO	12,0-13,0	63,55
ER40-14	13,0-14,0	49,69	ER40-14MICRO	13,0-14,0	63,55
ER40-15	14,0-15,0	49,69	ER40-15MICRO	14,0-15,0	63,55
ER40-16	15,0-16,0	49,69	ER40-16MICRO	15,0-16,0	63,55
ER40-17	16,0-17,0	49,69	ER40-17MICRO	16,0-17,0	63,55
ER40-18	17,0-18,0	49,69	ER40-18MICRO	17,0-18,0	63,55
ER40-19	18,0-19,0	49,69	ER40-19MICRO	18,0-19,0	63,55
ER40-20	19,0-20,0	49,69	ER40-20MICRO	19,0-20,0	63,55
ER40-21	20,0-21,0	49,69	ER40-21MICRO	20,0-21,0	63,55
ER40-22	21,0-22,0	49,69	ER40-22MICRO	21,0-22,0	63,55
ER40-23	22,0-23,0	49,69	ER40-23MICRO	22,0-23,0	63,55
ER40-24	23,0-24,0	49,69	ER40-24MICRO	23,0-24,0	63,55
ER40-25	24,0-25,0	49,69	ER40-25MICRO	24,0-25,0	63,55
ER40-26	25,0-26,0	49,69	ER40-26MICRO	25,0-26,0	63,55

AFIADORA PROFISSIONAL PATENTEADA PELA BLUE-MASTER



*Inclui mala e mó de repor.



Ref. AFB10



"Esqueça os problemas elétricos de outras afiadoras".
Inclui dispositivo anti curto-circuito.

AFB10

CAPACIDADE
AFIAÇÃO:Ø
3-13ÂNGULOS
DE PONTA:

118°

TIPOS DE
AFIAÇÕES:RE-AFIA
BROCAS:

HSS

HSSCo

MD

TIN

PMD

283,04 €

AFIE BROCAS EM 4 SIMPLES PASSOS:



1 Posicione e ajuste a broca na bucha.



2 Afie a broca.



3 Comprove a afiação convencional.



4 Afiação secundária em cruz (split point).

BUCHA DE REPOR

PAFB10
33,25 €

MÓ DE DIAMANTE DE GRÃO STANDARD

MAFB10
34,81 €

SUPORTE PARA AFB10

SOPAFB10
31,16 €

AFIADORAS DE BROCAS DRILL DOCTOR

750X
Alta Precisão



AFB1

CAPACIDADE AFIÇÃO:	Ø 2,5-19				
ÂNGULOS DE PONTA:	118°	135°			
TIPOS DE AFIÇÕES:					
RE-AFIA BROCAS:	HSS	HSSCo	MD	TiN	PMD
					520,19 €

* Inclui a mala.

Buchas e acessórios

Rosa

500X
Afição profissional



AFB2

CAPACIDADE AFIÇÃO:	Ø 2,5-13				
ÂNGULOS DE PONTA:	118°	135°			
TIPOS DE AFIÇÕES:					
RE-AFIA BROCAS:	HSS	HSSCo	MD	TiN	PMD
					436,95 €

XP
Prático e económico



AFB3

CAPACIDADE AFIÇÃO:	Ø 2,5-13				
ÂNGULOS DE PONTA:	118°				
TIPOS DE AFIÇÕES:					
RE-AFIA BROCAS:	HSS	HSSCo	MD	TiN	PMD
					210,57 €

ACESSÓRIOS PARA AFIADORAS

BUCHA PARA AFIADORAS



Para 750X

AFB1PB

78,72 €

Para Brocas à
esquerdas

AFB2PBI

78,74 €

MÓ DE GRÃO GROSSEIRO PARA AFIADORAS 750X, 500X



AFBT

73,14 €



AFBR

73,14 €

PARAFUSOS PARA AFIADORAS 750X E 500X



AFBTLL

8,63 €

SUPORTE PARA AFB10



SOPAFB10

31,16 €